

Polyend Play+ Manual

An Official Reference for The Polyend Play+

Contents

1 Overview	13
1.1 How to Use This Notebook.....	14
1.2 Hardware Overview.....	15
1.3 Start Up.....	17
1.4 Display Layout.....	18
1.5 User Interface Conventions.....	19
1.6 QWERTY Keyboard.....	20
1.7 Basic Playback.....	21
1.8 Basic Workflow Commands.....	22
1.9 Example Workflow.....	24
1.10 Quick Reference Commands.....	25
2 Architecture	29
2.1 Glossary of Terms.....	30
2.2 Play+ Audio Structure.....	32
2.3 Card Structure.....	33
2.4 Settings Menu Map.....	34
3 Projects & Tracks	37
3.1 First Steps with Projects.....	38
3.2 The Grid Overview.....	41
3.3 Track Structure Overview.....	42

3.4 Track Selection.....	43
3.5 Track Step Length.	44
3.6 Copy / Paste Steps Page and Tracks.....	46
3.7 Mute & Solo Tracks.	47
3.8 Master Volume.	48
3.9 Introduction to the Master Limiter.	49
3.10 Tempo.....	50
3.11 Swing.....	52
3.12 Play Mode.	53
3.13 Exporting Tracks.....	56
4 Parameter Summary	59
4.1 Parameter Overview.....	60
4.2 Master Volume / Limiter.....	61
4.3 Tempo / Track Swing.	62
4.4 Track Length / Play Mode.....	63
4.5 Note / Microtune.	64
4.6 Volume / Panning.	65
4.7 Filter Cutoff / Resonance.....	66
4.8 Sample / Folder.	67
4.9 Sample Start / Sample End.	68
4.10 Sample Attack / Sample Decay.	69
4.11 Reverb Send / Delay Send.	70
4.12 Overdrive / Bit Depth.	71

4.13 Repeat Type / Repeat Grid.....	72
4.14 Chance / Action.	73
4.15 Randomize / Randomize Type.	74
4.16 Move / Micromove.	75
5 Samples & Synths	77
5.1 Sample Pool.	78
5.2 Sample Format.	85
5.3 Sample Pack.	86
5.4 Deconstructing a Sample Pack.	87
5.5 Sample Selection Overview.	88
5.6 Sample Related Parameters.	89
5.7 Synthesizer Options	90
5.8 Synthesizer Patch Editor Basics.	94
5.9 Editing a Synthesizer Patch.	96
5.10 Synthesizer Macros.	117
6 Sequencing Patterns	121
6.1 What's a Pattern?	122
6.2 The Play+ Grid.	123
6.3 Sequencer Mode.	124
6.4 Introduction to Pattern Mode.	125
6.5 Pick & Place to Create A Pattern.	126
6.6 Work Step Options.	128
6.7 Select & Adjust Step Editing.	130

6.8 Copying & Pasting Steps.....	133
6.9 Live Recording.	134
6.10 View Mode.....	137
6.11 Piano Roll.	140
6.12 Scales.....	142
6.13 Using the Fill Tool.	144
6.14 Creating Custom Fill Patterns.	155
7 Arrangements & Variations	163
7.1 Pattern Mode.....	164
7.2 Managing Patterns.	165
7.3 Playing & Chaining Patterns.....	166
7.4 Track Variations.....	168
7.5 Creating / Deleting Variations.....	169
7.6 Playing Variations.....	171
7.7 Organic & Generative Arrangements.	172
7.8 Chance.....	173
7.9 Randomize.....	176
8 Perform Mode.....	181
8.1 Perform Mode.....	182
8.2 Punch-In effects.....	184
8.3 Perform Mode Quick Reference.....	185

9	Effects.....	187
9.1	Effect Architecture.	188
9.2	Master FX Presets.....	190
9.3	Master FX Custom Parameters.	191
9.4	Send Effects.	193
9.5	Master Reverb.	194
9.6	Master Delay.....	195
9.7	Distortion Effects.	196
9.8	Limiter.	197
10	MIDI.....	201
10.1	MIDI Terms.	202
10.2	Basic MIDI concepts for Play+.	203
10.3	MIDI Configuration.	205
10.4	MIDI Quick Start.	206
10.5	Typical MIDI Configurations.....	207
10.6	MIDI Mode.....	210
10.7	Sequencing MIDI Notes.	212
10.8	MIDI Fill.	214
10.9	Chords & Scales.....	216
10.10	CC Messages.....	218
10.11	CC Mapping.....	220

10.12	Program Change.....	223
10.13	Pitch Bend.....	225
10.14	Tracker MIDI Integration.....	226
11	System.....	229
11.1	Audio Output Over USB.....	230
11.2	Device Registration.....	235
11.3	Generic Firmware Update.....	236
11.4	Emergency Firmware Update.....	237
11.5	User Interface Style.....	238
11.6	SD Card Compatibility & Backing Up.....	240
11.7	USB Storage Access.....	242
11.8	Official Specifications.....	244
11.9	Changelog.....	245
12	Index.....	247

Contents

1

Overview

Polyend Play+ is a 16 track sample and synthesizer based groovebox with multitimbral polyphonic sounds, stereo functionality and audio over USB. Play+ takes the features and experience of the original Play instrument to new heights. Play+ is a complete musical production and live performance instrument using both **stereo sample** and **synthesis engine** audio sources for creating beats and building musical arrangements. Three synthesizers can be configured from the five available synthesis models. Three unique analog emulations, a percussion synth and one FM model are all available as sound sources and can be used for sequencing. Samples can also be used as the sound source. Over 5000 stereo and mono samples are provided to get started but you can add your own using the supplied microSD card. Both the capacity to create complete song arrangements and the skill to engage in live improvisation are equally

supported. The freedom to mix, play and sequence tracks and work both with synths, audio samples and control external polyphonic MIDI devices balances the 'in the box' thinking with 'out of the box' integration. Play+ is ideal as the central element in an integrated studio setup using the 8 Polyphonic MIDI / Synth tracks alongside the 8 audio tracks. A set of onboard effects including delay, reverb and saturation spice up the entire mix. Play+ has an expansive range of features including **audio over USB** for even tighter integration with other audio gear and digital audio workstations. The objective is to create and perform by coupling less traditional techniques alongside familiar processes to capture musical ideas and perform full song arrangements. User experience is at the heart of Play+ workflow and follows simple processes that enable almost instantaneous productions and advanced audio design and music creation

1 Overview

1.1 How to Use This Notebook.

This book combines a formal reference alongside your own notes and comments, collectively bringing together a comprehensive guide to Play+.

Sections are laid out to cover the full workflow with walkthroughs, step by step guides and tips. Some pages carry a wide margin and some are intentionally blank enabling you to make your own notes.

Control conventions.

(Knob)

Rounded parentheses represent the 15 touch capacitive knobs. Selected functions can be controlled or changed depending on the context. The knobs will be labelled by its primary or secondary function name. Also the multi-function screen navigation knob is included, labelled as (Screen).

[Function]

Square parentheses contain functions that are selectable by a physically dedicated button - either as a primary or secondary, shift accessible function. Examples are [Copy] and [Fill].

[Function] + [Option]

Functions which require multiple button selections simultaneously are shown with a + symbol between each required button. An example is the [Shift] + [Paste] command. The secondary function label is named.

[Pad]

Each of the 160 pad buttons will be simply represented by [Pad]. These functions will depend on the mode and function selected within Play+.

[Dynamic Screen Key]

The 5 dynamic screen buttons located underneath and to the left of the display screen will be identified using *italic* text. The actual function that each button serves will change depending on the current context. The function it serves will be labelled on the screen alongside each physical button on the device.

'Text'

Any screen menu options and text is indicated with quote marks.

NOTES

Your Notes Can be written here Here

Did you know?
In Dictionary terms the word 'play' is described as taking part in an enjoyable pastime or to perform?

1.2 Hardware Overview.

3.5mm Stereo audio output also serves as headphone out.

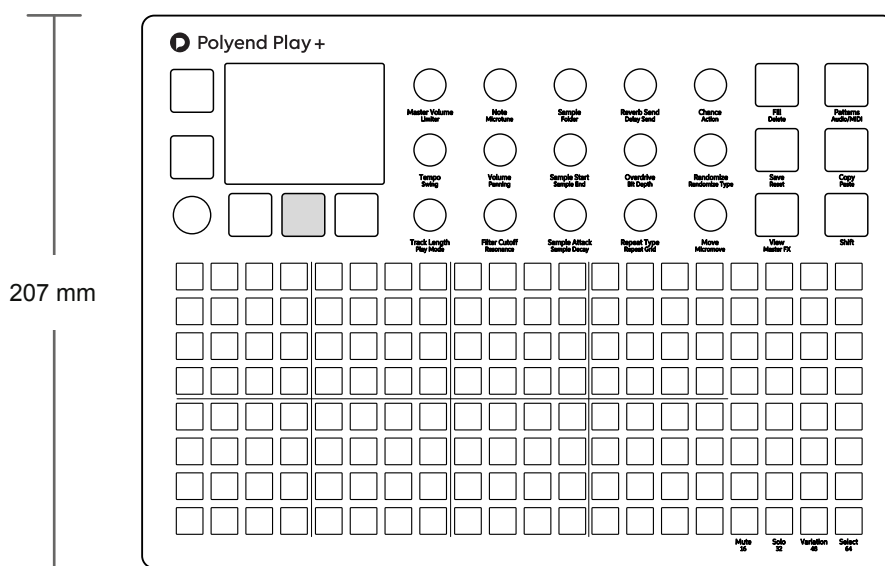
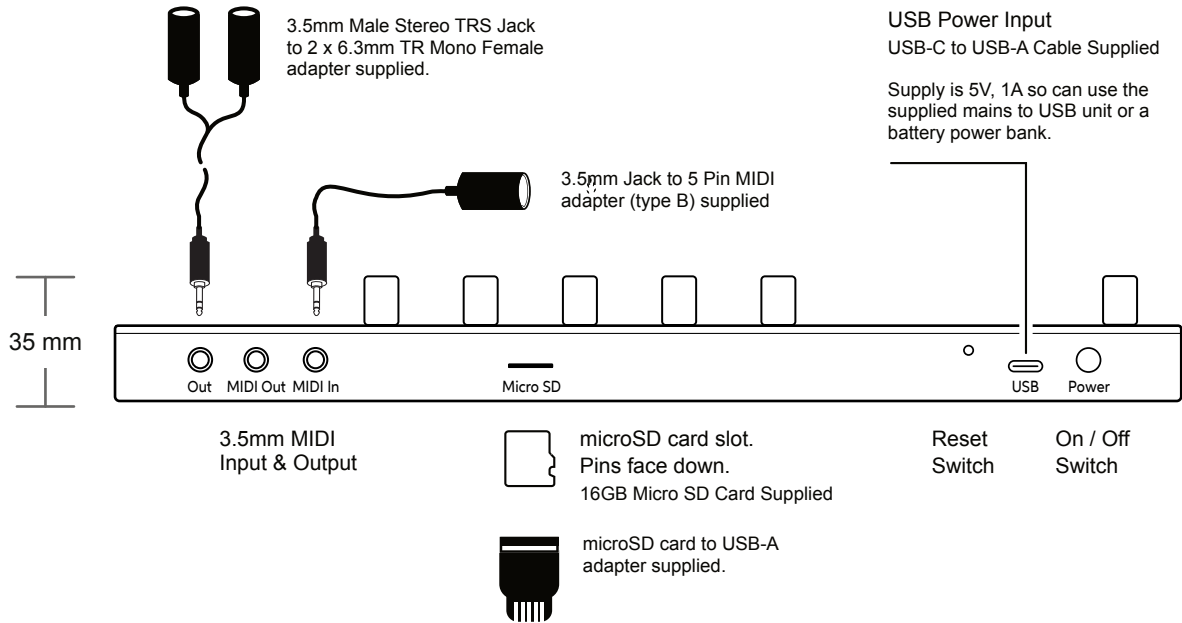

1 Overview

- 1** LCD Display
Hi Resolution Display.
- 3** Multi-Functional Screen Knob
Clickable encoder.
- 5** Function Pads
8 x 4 Silicone Pads. Multifunction columns used for Mute, Solo, Variation, Select and chromatic mode.
- 7** Note & Microtune
Note pitch adjustments relative to a C4 note sample and micro tuning -100 to +100 cents

- 2** Screen Buttons
5 Dynamic [Screen buttons]. Dependant on the function displayed for each button.
- 4** Track Sequencer Pads
8 x 16 Silicone Pads. Track step columns used for sequencing, performing and arranging.
- 6** Master Volume & Limiter
Control of primary master volume dB level and the secondary limiter threshold option.
- 8** Sample & Folder
Sample selection from sample pool. Select sample folder. Sets device and patch in MIDI/Synth mode.

- 9** Reverb & Delay Sends
Reverb and Send levels to adjust the effect intensity.
- 10** Chance & Action
Determines if / when an action occurs. Special action after a step.
- 11** Tempo & Swing
Adjusts global or track BPM Tempo and swing value.
- 12** Sample Volume & Panning
Sample volume level deviation from 0dB original sample. Pan Left/Right.
- 13** Sample Start & End
Trims the start and the end point of the sample.
- 14** Overdrive & Bit Depth
Overdrive grit and amplification or reduces bit resolution.

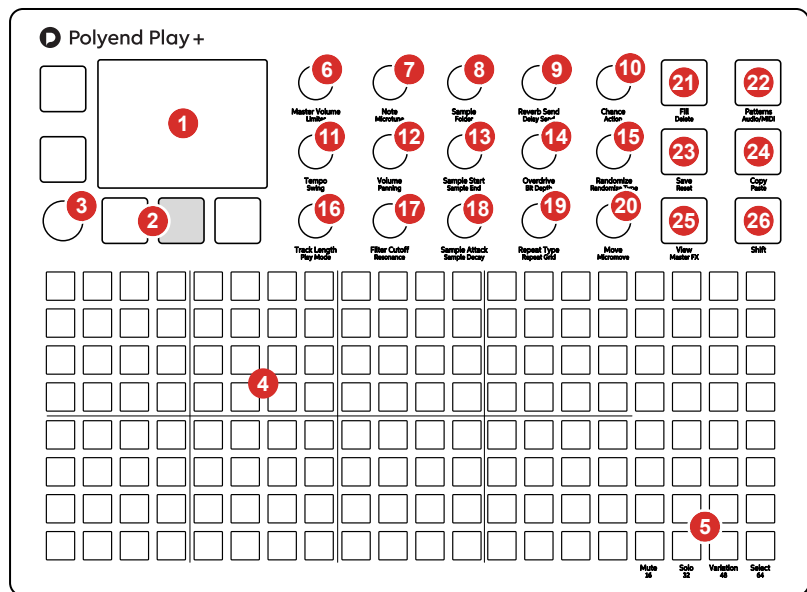

The 8 x 20 grid pads are not velocity sensitive.

- 15** Randomize & Randomize Type
Percentage randomization and type determines which step parameters are affected.
- 16** Track Length & Play Mode
Track length in steps between 1-64. Selects one of 35 play modes
- 18** Sample Attack & Decay
Sample start attack, fade-in time and the end of sample fade-out time
- 20** Move & Micromove
Move a step placement on the grid left or right and in smaller adjustments with micro move.
- 22** Patterns & Audio/MIDI Button
Pattern selection mode. Toggle between MIDI / Synth tracks and Audio sampling tracks
- 24** Copy & Paste Button
Copy and Paste various functions.
- 26** Shift Button
Hold shift plus another knob or button to access it's secondary function.

- 17** Filter Cutoff & Resonance
Adjusts the DJ style filter cutoff or resonance
- 19** Repeat Type & Grid
Selects the step repeat type from the list of options. Step repeat density is selected with grid.
- 21** Fill & Delete Button
Fill utility for generating and populating sequences. Delete option for various functions.
- 23** Save & Reset Button
Save current state of pattern and also recall using shift to restore the saved state.
- 25** View & Master FX Button
Changes the function pads to a chromatic input controller. Access audio processors using shift.

Some knobs change functionality when in MIDI / Synth mode. Audio Sampling mode is the default state.

1.3 Start Up.

Play+ is a low power user and can therefore be powered from the supplied mains USB adapter or from a rechargeable battery power bank. When restarting Play+ the previously open project will be re-opened

POWERING ON / OFF PLAY+

- Connect the supplied USB-C Mains cable between Play+ and the supplied USB plug. Also Play+ can operate with a portable USB power bank*. Play+ requires a 5V, 1A rated supply.
- Ensure the microSD card is installed correctly for Play+ to operate.
- Quickly press the small power button located on the rear left (looking from the top). Play+ will start up and the previous project reopened.
- To power off, press and hold the small power button located on the rear left (looking from the top) until the timer bar ends. Play+ will power off.

Supply is 5V, 1A from the supplied mains to USB adapter.

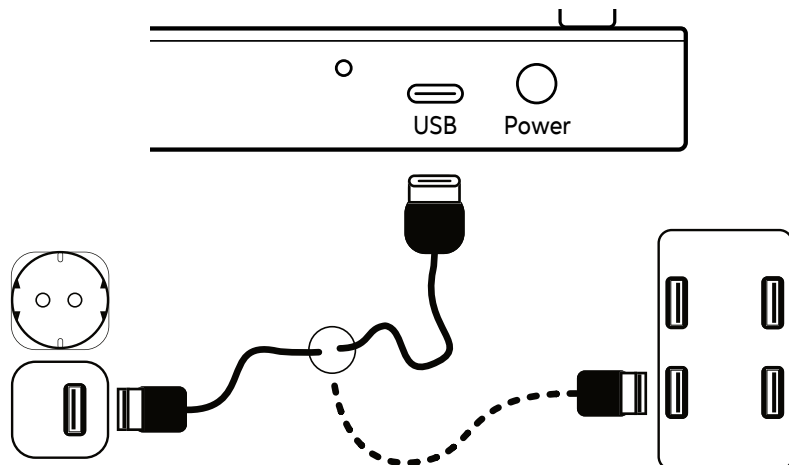

Alternatively use a battery power bank.
Start up instantaneous current is approx 1.2A with normal state around 0.5A

** It is recommended by Polyend to use a standard power bank without smart features. Intelligent / smart power banks or PC / Mac power may have features that interfere with the continuous supply required by Play+. USC - C to USB - A cable supplied.*

Warning:

Under-powering the Tracker from a hub or computer can result in performance issues or microSD card failure.

1 Overview

1.4 Display Layout.

NOTES

Each page will display the parameter information and control options for the selected function. While generally this is based on the context and mode of operation, there are some common features and navigation principles that apply across all (or most) of the generic pages of Play+.

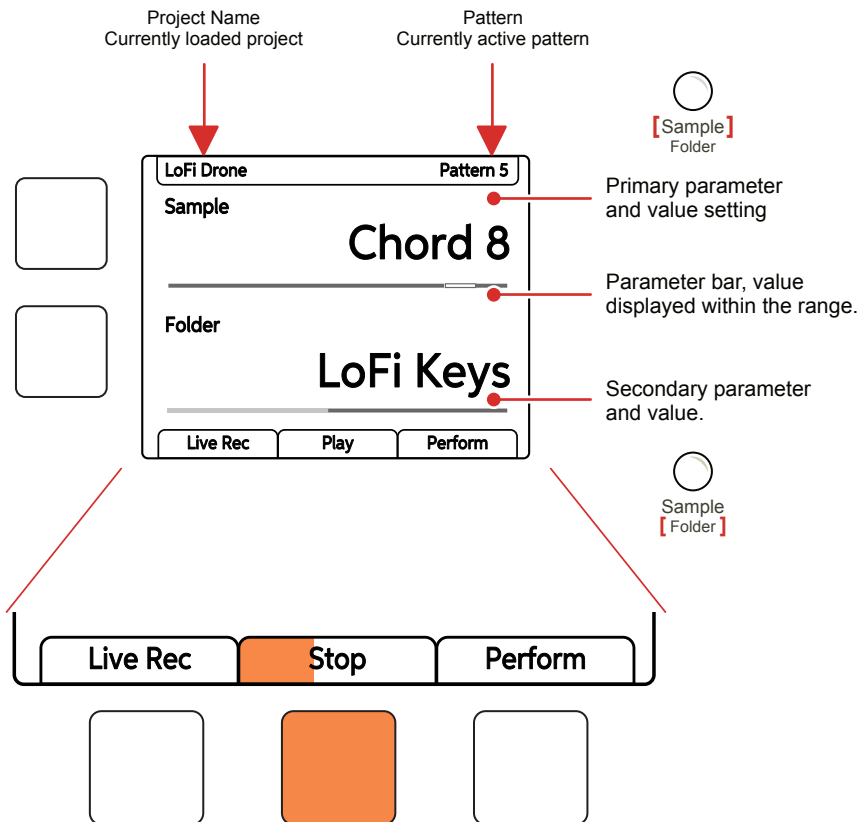

Physical screen buttons represent the command displayed on the screen directly above or to the right. The Play / Stop tab will show the playback progress bar when playing.

The top part of the screen will display the value setting of the primary parameter selected. The parameter knobs are touch sensitive and selected by tapping the knob. The primary parameter is labelled in the large font under the knob. The lower, smaller font labelled parameter refers to the secondary parameter for the knob, accessed by double tapping the knob, the value of which is displayed in the lower part of the display.

The two left side dynamic buttons also can be used to select between the two upper and lower parameters. The left buttons can be used to perform the same 'select' action as pressing the (Screen) knob. Otherwise the buttons activate the function labelled on the screen.

1.5 User Interface Conventions.

Adjusting parameters and setting steps follows a defined process. Simply tapping a pad will select / deselect. Parameter adjustments uses the knobs which are touch capacitive meaning the parameter is automatically selected when touched by hand. Behaviour can be changed in the global settings.

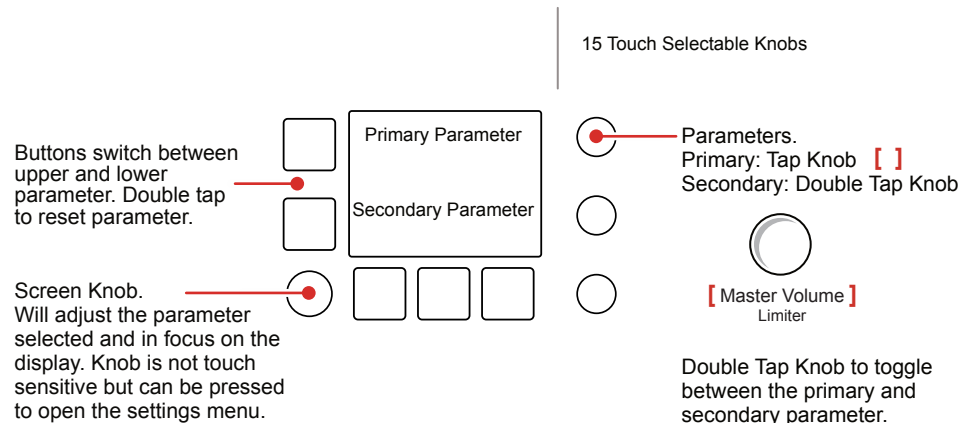

Notes on using the control interface

- The 15 Parameter knobs are touch sensitive and the primary parameter is automatically selected when touched.
- Double tap any of the 15 knobs to switch between the primary and the secondary parameter. The selected parameter is emphasised on the display and the parameter deselected will display greyed out. This behaviour can be changed in the settings menu.
- The upper and lower left side screen buttons can select between the primary and the secondary value.
- Turn a (Knob) to change its value.
- Press [Shift] + Turn (Knob) on some parameters to change the value with a faster resolution of adjustment. This will increase the speed of adjustment when changing values across its range. This precise behaviour is dependant on the parameter selected.
- The (Screen) knob is not touch sensitive. The rotation has detent control and is push clickable. Press (Screen) to select and to navigate the global settings menu.
- The (Screen) knob will change any selected parameter value in the same way as the parameter knob. It will also navigate within the global settings menus.

1 Overview

1.6 QWERTY Keyboard.

NOTES

Some pages will require text editing for naming items i.e. projects. The same functionality applies whenever the Alpha numeric pop-up editor is used. The screen will display the QWERTY keys and the text to edit, while part of the 8 x 16 pad grid will act as the keyboard's keys. The dynamic screen buttons are used to Confirm, Caps Lock, Back or Auto Name.

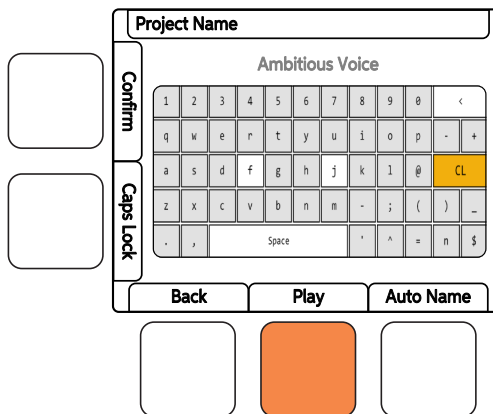

The screen will display the keys which are represented by the grid pads. The 'f' and 'j' keys are highlighted to give a reference between the pads and the screen characters. Current character is lit orange. Text can be typed in to enter.

1	2	3	4	5	6	7	8	9	0	<	
q	w	e	r	t	y	u	i	o	p	-	+
a	s	d	f	g	h	j	k	l	@	CL	
z	x	c	v	b	n	m	-	;	()	_
.	,	Space					'	^	=	n	\$

The following Play+ buttons also operate in the naming editor when the naming screen is presented:-

- The characters can also be selected by turning (Screen).
- Press (Screen) to add the highlighted character at the current cursor position.
- Press [Fill] to backspace delete the character before the cursor
- Move character cursor left / right within in the text name to edit by holding [Shift] + Turn (Screen)

1.7 Basic Playback.

General pattern playback is activated using the orange *[Play]* button. The tracks and patterns to play are determined by what is currently selected and active. Playback duration is indicated in a bar on the dynamic Play/ Stop Button. Note that there are more advanced play options covered later in this book. The master volume controls the overall output of the Play+ device. Care should be taken when playing songs and especially if listening with headphones. It is advised to firstly set the master volume to a desired low level at the outset.

PLAYING AND STOPPING PLAYBACK

1. Ensure a project with patterns is loaded.
2. Press *[Play]* to play the currently active pattern. The Play button is colored orange and located as a dynamic screen button centrally placed under the display.
3. Press *[Stop]* to stop playback and reset the playhead to the start. The Stop button is the same physical button as *[Play]* colored orange and located as a dynamic screen button centrally placed under the display.
 - Pressing *[Play]* again restarts from the pattern beginning.
 - Pressing *[Shift] + [Play]* will play a chained pattern series.
4. If a long sample tail is audible after the sequencer is stopped, the audio can be curtailed by tapping (Master Volume).

ADJUSTING THE MASTER VOLUME.

1. Touch (Master Volume) to select and display the parameter.
2. Turn (Master Volume), ideally while Play+ is playing to hear the level changes applied. Alternatively Turn (Screen) knob while Master Volume is displayed and selected as active to edit.
3. The volume level, as displayed on the primary slot on the screen, and can be adjusted between -51.5dB to +12dB in 0.5dB iterations. The level bar below the numeric setting also indicates the level position within the range.

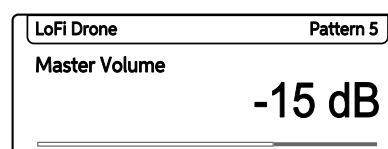

1 Overview

1.8 Basic Workflow Commands.

NOTES

A number of commands operate generically and apply in more than one situation. Quick copy/paste and Undo/Redo are just some examples.

■ QUICK COPYING & PASTING

1. Quick copy and paste is a workflow process used to copy steps, step pages, variations and patterns.
2. Keep Holding Source [Pad] for the active step to copy to clipboard until it flashes blue twice, then Press Destination [Pad] to copy into.
3. If the source is still held other multiple destinations can be pasted into.

■ UNDO / REDO

1. Some activities can be backtracked and undone or reset and redone. The Undo / Redo function can apply these in various scenarios. This is useful to correct mistakes or allow things to be tried and restored. Play+ has 16 undo / redo layers.
2. Hold [Shift], if the undo / redo options are available they will be visible on the screen dynamic buttons. They may be greyed out if no undo/redo option is currently available.

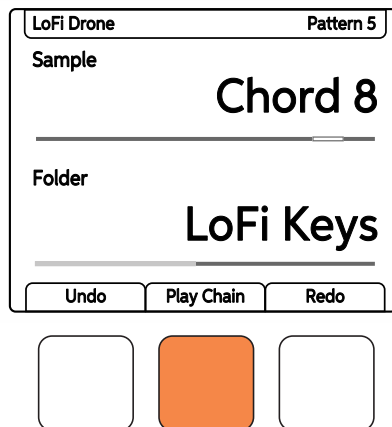

The Undo / Redo options are available when holding [Shift]. These may be dimmed grey if no undo / redo is available

NOTES

RESETTING PARAMETER DEFAULTS

1. Tap a knob to select a parameter to reset in view. The parameter will be shown in the display screen.
2. Quickly, double tap the left screen button for the parameter to reset. The value will return to its default level. The upper and lower screen buttons represent the upper and lower parameter.

SAVE / RESET THE CURRENT PATTERN STATE

1. Press [Save] to save the current session state.
2. Press [Shift] + [Save] to reset and restore the session state.

STEP & TURN PARAMETER PREVIEW

1. To preview a parameter while turning the knob, the sequencer should be stopped. Turn (Knob) for the parameter to adjust and preview. Knob preview behaviour can be changed in the main menu settings.
2. To preview a note step. Press and Hold (Screen) knob + hold [Pad] for the step with a note to preview.

1 Overview

1.9 Example Workflow.

The workflow adopted with Play+ will of course develop to fit your personal approach. To get started a typical journey is described below which covers the sample tracks but a similar process is applied for MIDI / Synth tracks.



1.10 Quick Reference Commands.

Function	Action	Play+ Buttons	Description
General	Master Volume	Turn (Master Volume)	Adjusts the master output level
General	General Navigation	Turn (Screen)	Generally navigate, scroll menu selections and options
General	Main Menu	Press (Screen)	Select the main menu options. Display's prior selected menu.
General	Tempo	Turn (Tempo)	Adjust the global tempo. Will use an external tempo if another device is connected for MIDI clock.
General	Redo / Undo	Hold [Shift] + [Screen]	When shift is held, the undo / redo is presented, if available, on the lower screen buttons.
General	Cut off tail	Tap (Master Volume)	Curtail playback of any audio tail immediately. Tap when sequencer is stopped.
General	Save Current State	Press [Save]	Save the current state of the session.
General	Reset Current State	Press [Shift] + [Save]	Restore / reset the saved state of the session.
General	Alphanumeric Char	Turn (Screen) or Press [Pad]	In the Alphanumeric QWERTY editor ie naming. Selects the character. Also press pad for character to select.
General	Select Character	Press (Screen)	In the Alphanumeric QWERTY editor ie naming. Adds the selected character.
General	Delete Character	Press [Fill]	In the Alphanumeric QWERTY editor ie naming. Backspace delete through characters.
General	Move Char Cursor	Hold [Shift] + Turn (Screen)	In the Alphanumeric QWERTY editor ie naming. Moves character entry cursor.
Project	Open/Create Project	Press (Screen)	Select the main menu options. File menu enables the opening, saving, creating of projects.
Parameter	Select Parameter	Tap (Knob) for parameter	Select the parameter for view and editing.
Parameter	Change Parameter	Turn (Knob) for parameter	Edits the parameter in view. Also turn (Screen).
Parameter	Change Parameter	Hold [Shift] + Turn (Knob)	Edits the parameter in view with a higher increment.
Parameter	Select Parameter	Double Tap (Knob) for parameter	Select between secondary and primary parameter for view and editing.
Parameter	Reset Parameter	Hold [Pad] + Double Tap [Screen]	With the parameter selected and in view, hold the pad and quickly double tap the respective left side screen button.
Sequence	Play Pattern	Press [Play]	Screen Play button will play and loop the current pattern
Sequence	Play Pattern Chain	Hold [Shift] + Press [Play]	Screen Play button will play and loop the chain of patterns
Sequence	Stop Playback	Press [Stop]	Screen Play button while playing, will stop playback
Sequence	Sequencer Mode	[Patterns]	Selects between sequencer and pattern modes. Sequencer mode enables creation and editing of steps to a pattern.
Sequence	Create Step	Tap [Pad]	Adds a step to a pattern with work step settings. Operates in sequencer mode.
Sequence	Remove Step	Tap [Pad] on existing step	Removes a step from a pattern. Sequencer mode.
Sequence	Edit Step	Hold [Pad] on existing step	Adjust parameter while holding step. Sequencer mode.

1 Overview

1.10 Quick Reference Commands.

Function	Action	Play+ Buttons	Description
Sequence	Copy Step	Hold [Pad] on existing step	Hold until step flashes to copy to clipboard. Sequencer mode.
Sequence	Quick Copy/Paste	Hold [Pad] A + [Pad] B	Copies Step A and pastes to Step(s) B. Sequencer mode.
Sequence	Select Step Range	Hold [Shift] + [Pad] A then [Pad] B	Selects a range of steps across tracks using a selection rectangle where pads refer to diagonally opposite corners. Keep shift and first pad held. Set in Sequencer mode.
Sequence	Select Multiple Steps	Hold [Shift] + [Pad] A , [Pad] B etc	Selects multiple steps with individual selections. Keep shift held then select pads. Set in Sequencer mode.
Sequence	Live Recording	Press Live Rec [Screen] Button	Selects live recording mode. Notes played by MIDI, View Keyboard and parameter changes are recorded. Play the sequence to start recording to the pattern.
Sequence	View Mode	Press [View]	Switches the last four column from function mode to view mode. Notes can then be played in like a virtual MIDI controller. Mode can be set in configurations.
Sequence	Piano Roll	Hold [View]	Presents the pads as a piano roll.
Sequence	Transpose View	Press [Pad] Col 17, 18, 19, 20.	In view mode, the top row of function pads can transpose the view keyboard octave range.
Sequence	Fill Steps	Press [Fill] - Type/Density - [Fill]	The Fill command will populate a set of selected steps or tracks based on the type and density parameters.
Track	Select Track	Press Select [Pad] - Column 20	Each select pad will select the track, represented across the pad grid rows. Tracks selected will also select steps.
Track	Mute Track	Press Mute [Pad] - Column 17	Each Mute pad will silence one of the 8 tracks. Tracks are presented as pad rows.
Track	Solo Track	Press Solo [Pad] - Column 18	Each Solo pad will solo one of the 8 tracks. Tracks are presented as pad rows.
Track	Track Variation	Press Variation [Pad] - Column 19	Each Variation pad will view the track variations represented across the pad grid rows. Variations can be selected.
Track	Track Length	Turn (Track Length)	Adjusts the number of steps in the selected tracks between 1-64 steps.
Track	View Step Pages	Hold [Shift]	Views the available step pages on the function pad buttons. First row 1-16, second 17-32 etc, labelled under pads.
Track	Select Step Pages	Hold [Shift] + Function [Pad]	Pads on each row represents available step pages for each track. The page can be selected which displays the selected steps on the 8 x 20 grid pad layout.
Track	Quick Length Edit	Hold [Shift] + Function [Pad]	Pads on each row represents available step pages for each track. Selecting the page will automatically extend the steps.
Track	Copy Step Page	Hold [Shift] + [Pad] A then [Pad] B	Hold the function pad for the page to copy. While still holding shift & pad, press the pad for the page to copy into.
Track	Copy Tracks	Press [Copy]	Select tracks to copy then press copy. Pasting into a selected audio or MIDI track will paste with the same track order.
Track	Export Tracks	Press (Screen)	Select the main menu and the file submenu. Several export options are available.
Pattern	Pattern Mode	Press [Patterns]	Selects between sequencer and pattern modes. Pattern mode enables management and chaining of all patterns.
Pattern	Select Pattern	Press [Pad]	The 8 x 20 grid pads represent pattern slots. Patterns for editing in sequencer view can be selected here.
Pattern	Quick Copy/Paste	Hold [Pad] A + [Pad] B	Copies Pattern A and Pastes to Pattern Slot (s) B. Pattern mode must be on.

1.10 Quick Reference Commands.

Function	Action	Play Buttons	Description
Pattern	Chain Pattern	Assemble Patterns in Order	Assemble a series of patterns in a sequential order in pattern mode. Set an empty pattern slot at the end to trigger loop.
Pattern	Delete Pattern	Hold [Pad]s + [Shift] + [Delete]	Deletes one or more patterns when in Pattern mode.
Pattern	Cue Pattern	Press [Pad]	When a chain is playing in pattern view, pressing a pad cues it ready to play next, after completion of current pattern.
Pattern	Play Pattern	Press [Shift] + [Pad]	When a chain is playing in pattern view, pressing pattern / shift + pad will play immediately.
Perform	Perform Mode	Tap Perform [Screen] button	Selects Perform mode ready for on the fly punch in effects.
Perform	Latch Perform Effect	Tap [Pad] 8 x 20	Tap to latch / unlatch the effect. The 8 x 20 Grid pads represent the punch in effects. Tracks must be selected first to apply the effect.
Perform	Punch In Effect	Hold [Pad] 8 x 20	Hold to apply an effect only while holding the pad. The 8 x 20 Grid pads represent the punch in effects. Tracks must be selected first to apply the effect.
MIDI	MIDI Mode	Press [Audio / MIDI]	Switches between Audio track mode and MIDI / Synth track mode and will display the function pads in purple.
MIDI	MIDI Configuration	Press (Screen)	The MIDI configuration is contained in the MIDI section of the main menu.
MIDI	MIDI Channel & Port	Turn (Sample)	The Sample knob option will operate to set channel and port in MIDI Mode.
MIDI	Pitch Bend	Double Tap & Turn (Microtune)	The Note knob option will operate as a pitch bend function using the secondary Microtune parameter.
Synths	Synth Mode	Press [Audio / MIDI]	Switches between Audio track mode and MIDI / Synth track mode which will display the function pads in purple.
Synths	Synth Configuration	Press (Screen)	The Synth configuration is contained in the Synths section of the main menu. This includes assigning synth models.
Synths	Synth Selection	Turn (Sample)	The Sample knob option will operate to set MIDI devices and also select one of the 3 available synthesizers.
Synths	Patch Selection	Turn (Sample) Secondary Param	Tap Sample then turn to adjust the patch selection. This is the secondary folder labelled option.

2

Architecture

Make no mistake, Play+ is a unique yet comprehensive device. There are so many features that are less obvious to producers who are familiar with more traditional sequencers and DAW's. The overall structure of Play+ can seem at first glance to be daunting. However it is actually quite simple and by spending a little time to understand the overall architecture and terminology then this will set a good starting foundation. For this reason there are no apologies for taking a short time to get intimate with the architecture of the overall device and bringing this summary upfront in this guide. Getting a solid understanding and awareness of the Play+ structure will help enormously in getting to grips later with the rest of the device. The three basic elements to get started are Play+ itself (of course), a USB power source (Power-pack or mains adapter) and the populated and configured microSD Card which is integral to Play+ operation. It is also possible

to interface Play+ with other audio and MIDI devices to expand the system. While more in depth details for specific topics are covered in the following sections of this notebook, the overall foundation and structure is laid out in this section. The hierarchical structure and organisation of data and functions such as Projects, Patterns and Steps are summarised collectively and how they work together. It is therefore worth the investment of time and focus in understanding the architectural hierarchy. Developing a fundamental workflow and efficient process will help get the most out of Play+ wide feature set.

2 Architecture

2.1 Glossary of Terms.

While you may think this should be hidden at the back of this book, understanding the terminology associated with these topics and especially with Play+ will help unlock it's power and performance. It makes sense to become familiar early with the essential terms to help embed into your workflow

Beta: A term normally used for pre-release software versions used for testing purposes. Polyend often release beta versions of Play+.

Delay: An effect function which creates echo's and repeats of the audio signal.

Effects: Refers to the master effects used across the overall output audio. Also called FX.

Envelope: An envelope is used to modulate and shape parameters and audio over time. Play+ has Attack and Decay Envelope control.

Fill: A utility used to creatively and automatically populate and edit the pattern notes and values.

Function Pad: The last 4 columns of grid pads on the far right side. Used for specific functional controls of tracks.

Limiter: A dynamic processing function used to tame transients and control level limits by adjusting down the volume when a threshold is exceeded.

Looping: The process of replaying audio or a pattern continuously in a defined cycle e.g. start to end then start to end.

MIDI: MIDI stands for Musical Instrument Digital Interface and is a standard protocol used for communicating between equipment. MIDI is normally applied using 5 Pin MIDI DIN connections which in some cases (i.e. with Play+) are interfaced via a MIDI 5 Pin to 3.5mm MIDI Dongle.

Mute: Muting offers variations that can be created by silencing the play out of individual tracks, used for sound design purposes and especially when playing live sets.

Note: A musical note assigned to a samples pitch and assigned to track steps to create a melody or percussive beat.

OS: Operating System is the core software that makes Play+ work. It handles how it operates and periodic updates from Polyend bring new features into use.

Parameter: The individual value of a specific function or control element. A parameter can be adjusted to affect a sound or a functions operation.

Pattern: This is the backbone and core of a Play+ sequence and contains all steps in a sequence. Patterns operate in series to control how tracks and associated steps are played.

Pattern Mode: The 8 x 16 grid pads will allow chaining and arranging of patterns.

Perform: A mode in Play+ that provides an environment with a wide range of selectable effects which can be triggered live and during improvisations.

Play+: Play+ is a groovebox for music production. Play+ use a sequencing environment similar to a digital audio workstation and focusses on the 'in the box' immediacy and user experience of the hands on creative environment.

Power Bank: A portable rechargeable battery devices used to power or recharge portable equipment.

Project: The overall structural container for patterns, samples, etc. A project should always be loaded to work with Play. Up to 128 patterns can be contained in a project.

RAM Memory: While Play+ operates with the microSD card, on board RAM memory is also used for managing samples in the project sample pool.

Reset: The process of restarting Play+ by loading a random OS firmware. Also the term 'reset' is used for recalling a previously saved pattern.

Reverb: An effect function which emulates the behaviour of audio in a room or space. The echos and reflections form the sound character.

Sample: The basic audio element loaded into Play+ and used as the primary sound source. Samples are accessed via the microSD card but can be loaded into the on board sample pool. Samples can be used as the sound source.

Sample Pack: A concept in Play+ where samples are organised and named in a format that allows intelligent access of Play+ functions. Also a standard set of samples can be provided in a sample pack.

Sample Pool: The on board memory for storing and managing samples in Play+. Samples must be copied from the microSD card to each project's Sample Pool to allow the sequencing.

Screen Buttons: 5 dynamic buttons which will operate functions based on the mode. The function is displayed on the screen and commonly includes play / stop for the sequencer.

SD Card: A storage device that is used in Play+ for holding data, samples, project etc. Play+ is supplied with a 16GB microSD Card and USB adapter.

Sequencer: The function that manages and controls the assembly and operation of patterns.

Sequencer Mode: The main 16 x 8 Grid pads which allow sequencing of a pattern

Solo: The ability to select an individual track to play alone and effectively mutes other tracks.

Step: In Play+ a step is the building blocks for creating melodies and beats. Each step contains a sample as the sound source and is managed in the displayed track rows. In MIDI Mode as step will output Note, CC and/or PC messages.

Swing: The natural feel of a pattern and introduced in Play+ by shifting some steps slightly early or late.

Synth: An electronic instrument for creating sounds. Play+ has 3 onboard configurable synths that can be used as a sound source. Various synth models are available.

Track: Play+ contains 8 Audio tracks and 8 MIDI / Synth Tracks. Tracks operate together in parallel and are used for structuring the sequencing of steps. These can be configured to develop a complete melody and beat.

Update: The process of installing the newest firmware. This brings new features and fixes bugs associated with previous versions.

Variation: In Play+ a variation is an alternative version of the track, which is stored and accessed through 1 of 16 slots.

View Controller: This selects the 4 function pad columns to act as a MIDI note input tool. Similar to the layout of a piano keyboard.

Work Step: The creation of a generic set of parameters and sample selection held in memory. This is then the values and state of a step when placed into the grid.

2 Architecture

2.2 Play+ Audio Structure.

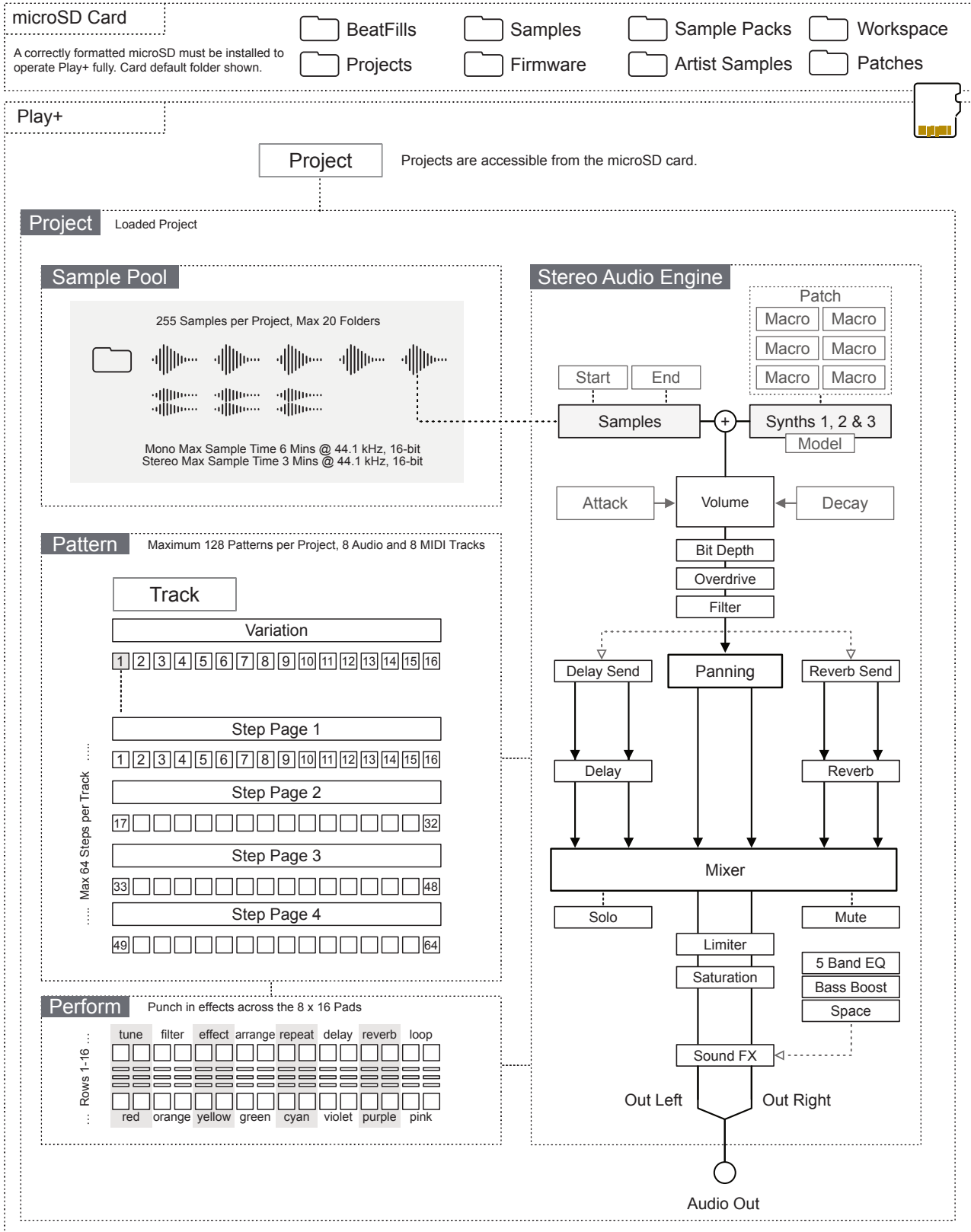

2.3 Card Structure.

The microSD Card is an integral part of Play+ and must be inserted to operate correctly. An alert message is displayed if Play+ is powered up without an microSD card installed. It is important that the correct format is applied to the microSD card. This should be FAT32 with Master Boot Record (MBR) Partitioning.

The default file structure will expand as different functions are used.

Files and folders can be accessed with a PC or Mac. A USB microSD card adapter is supplied with Play+.

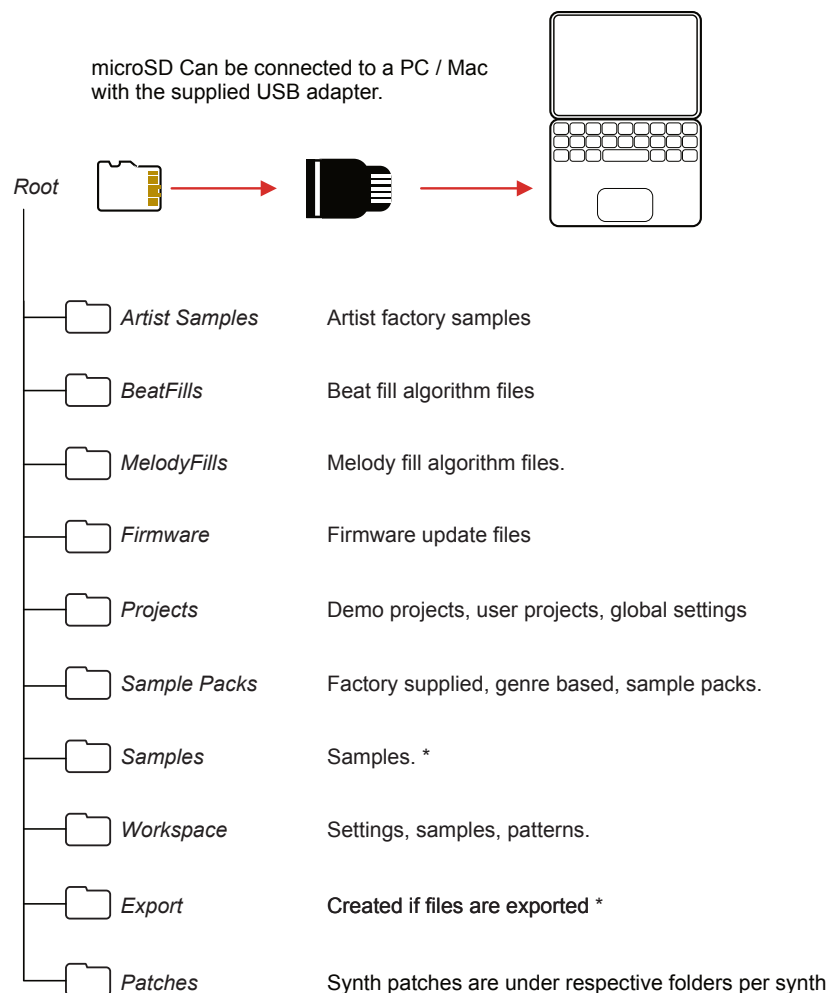

* Folders may be created when accessing these functions in Play+.

Always backup the microSD card content on a regular basis and before performing an OS Update. Some new folders may require user created content such as beat fill templates to be relocated when an update is introduced. Check each update documentation from Polyend when an update is released for specific information.

2 Architecture

2.4 Settings Menu Map.

NOTES

As a quick guide to the settings and menu hierarchy in Play+ the following diagram illustrates the main pages.

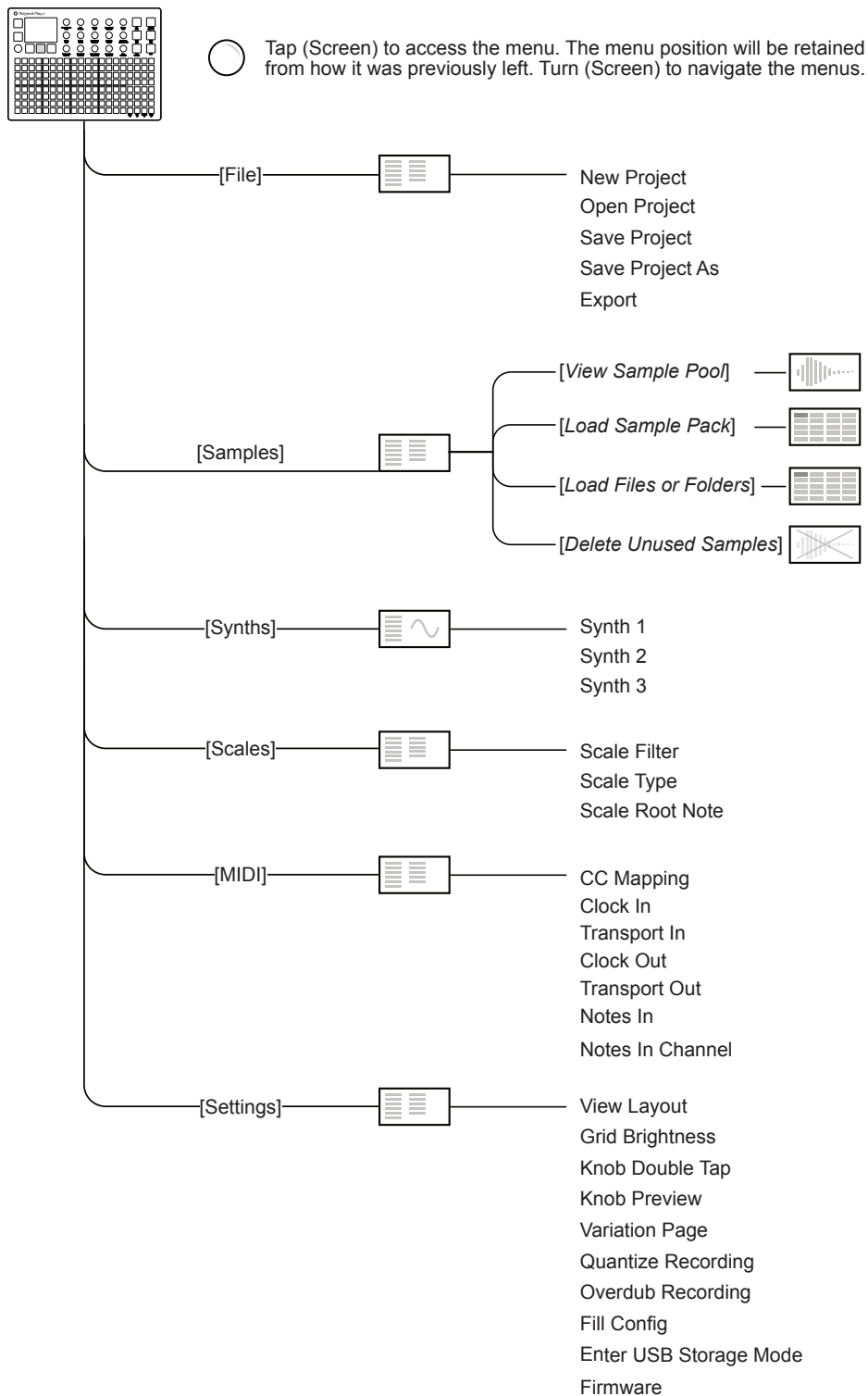

Menu	Option	Description
File	New Project	Create a blank new project
File	Open Project	Open an existing saved project
File	Save Project	Save the current project
File	Save Project As	Save and rename the current project
File	Export	Export patterns, chains and pattern stems
Samples	View Sample Pool	View current project samples. Create & rename folders.
Samples	Load Sample Pack	Loads a sample pack from microSD to Project
Samples	Load Files or Folders	Loads a folder and complete structure of files to project sample pool.
Samples	Delete Unused Samples	Remove all samples from project that are not used.
Synths	Synth 1, 2, 3	Synthesizers x3. Configurable with 1 of 4 synth models plus patches.
Scales	Scale Filter	Sets the scale filter on or off. This ensures notes remain within a scale.
Scales	Scale Type	Select from a range of scale options.
Scales	Scale Root Note	Select root note.
MIDI	CC Mapping	Parameter knob mapping to CC numbers
MIDI	Clock In	Clock source, Internal, MIDI In jack or MIDI In USB
MIDI	Transport In	Sets the input of transport control commands, Off, MIDI In jack or MIDI In USB
MIDI	Clock Out	Sets the clock output, Off, MIDI Out jack or MIDI Out USB, MIDI Out USB and Jack
MIDI	Transport Out	Sets the transport output, Off, MIDI Out jack or MIDI Out USB, MIDI Out USB and Jack
MIDI	Notes In	Sets the input routing of external notes in. Set to Off, MIDI In jack or MIDI In USB.
MIDI	Notes In Channel	Specific channel for notes in for the work step. Omni refers to all channels.
Settings	View Layout	Sets the view pad option to layout as piano style or grid note style
Settings	Grid Brightness	Sets the grid illumination brightness to a level of High, Medium or Low.
Settings	Knob Double Tap	Sets knob tap behaviour. Double tap can be turned on or off.
Settings	Knob Preview	Selects how the audio preview is performed. Can be set to; Off, Stopped, Playback, Stopped & Playback.
Settings	Variation Page	Sets the behaviour of the variation page between separate tracks or all tracks.
Settings	Quantize Recording	Quantize recording on or off.
Settings	Overdub Recording	Overdub recording on or off.
Settings	Fill Config	Sets the source for the MIDI fill notes for beats and MIDI channels for beat and melody fills
Settings	Enter USB Storage Mode	Allows connection of a PC/Mac to access the microSD card for file and sample management.
Settings	Firmware	Displays version and initiates a firmware update from a selected update file

3

Projects & Tracks

Projects are the highest order structural element in Play+. A project contains all the elements of a full track. Think of each project as the container for a fully arranged song maybe for an album or a song for performing in a live set. Play+ auto saves projects, which are stored on the installed microSD card, although a manual save option is also provided. A project should be opened for playback and editing and can be created from scratch for new projects. Each project contains a maximum of 128 patterns across 8 audio tracks and 8 MIDI / Synth tracks. Patterns can be created as sample based compositions and also as MIDI / Synth based sounds. Sample tracks are indicated by green function pads, which is the default state and illuminated purple for MIDI / Synth tracks. Projects are structural and organisational functions more so than part of the creative environment but nevertheless serve an important purpose in

the Play+ workflow. Samples are stored on the microSD card but can be also are held in the Play+ on board sample pool where samples effectively are the sound source of step sequences and patterns. Projects use the on board sample pool which is populated with samples or sample packs from the microSD card. Having the project sample list populated is a prerequisite to creating pattern sequences and is core part of the project workflow. Synth patches are also stored on the microSD card. This section covers the general project management in Play+ and also the files from it's microSD card. Some important and specific project level functions such as tempo and levels are also covered. The 8 sample tracks also have some specific functionality to consider which is covered here while MIDI and Synths are covered in detail later in this manual.

3 Projects & Tracks

3.1 First Steps with Projects.

NOTES

A project must be open when working in Play+. The previously selected project will be opened automatically on start up. Other projects however can be opened or created. Ensure the microSD card is installed into Play+.

OPENING AN EXISTING PROJECT

1. When powering on the previous project will be restored. Projects can be changed or new ones created. Projects are stored on the microSD.
2. Press (Screen), the multi-functional screen encoder. The main menu will be displayed. Turning (Screen) will navigate the menu.
3. Turn (Screen) to highlight 'File' in the menu.
4. Press (Screen) to select the highlighted 'File' option and to open the submenu options.
5. Turn (Screen) to highlight 'Open Project' in the menu.
6. Press (Screen) to select the highlighted 'Open Project' option.
7. A prompt 'Do you want to to save the current project?' may be offered. To save, press [Yes] on the left dynamic screen button. If no message is displayed, i.e. project is already saved, skip this step. Option not to save is also presented.
8. The microSD card browser will display the folders for the available projects. The demo project folder will host the factory projects while user projects will also be available as named. The (Screen) encoder can be used to navigate by turning and to select a folder. Main folders are represented by white text. Press the (Screen) encoder on a folder to open its submenu. Projects folder can be navigated up and down in the structure.
9. Turn (Screen) to highlight a project to select. Projects, i.e. project folders are represented by orange text in the browser display.
10. Press [*Open*] using the lower dynamic screen button when the selected project is highlighted.
11. The progress bar will be displayed as the project is opened.

CREATING A NEW PROJECT

1. Press (Screen), the multi-functional screen encoder. The main menu will be displayed. Turning (Screen) will navigate the menu.
2. Turn (Screen) to highlight 'File' in the menu.
3. Press (Screen) to select the highlighted 'File' option and to open the submenu options.
4. Turn (Screen) to highlight 'New Project' in the menu.
5. Press (Screen) to select the highlighted 'New Project' option.
6. A prompt 'Do you want to to save the current project?' may be offered. To save press [Yes], on the dynamic screen button. If no message is displayed, i.e. project is already saved, skip this step. Option to not save is also presented.
7. A new project will be created with the default settings.
8. Once a project is created it is recommended to save. This is also performed in the file menu. 'Save' will perform a 'Save As' function if this is the first save. This will allow a name to be created or auto naming.

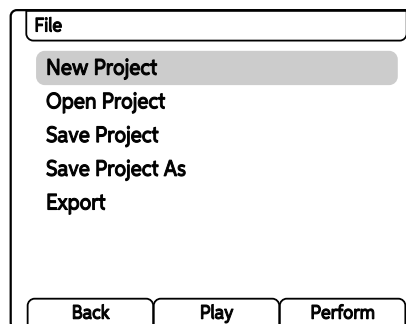

In order to get started with a new empty project, samples or a sample pack should be loaded and a sample or synth assigned to a work step in order to build patterns. The quick steps for samples are; 1) Press (Screen) to open main menu, 2) Turn & Press (Screen) to choose and select 'Samples', 3) Turn & Press (Screen) to choose and select 'Load Sample Pack', 4) Turn & Press (Screen) to choose and select the sample pack to load. Once loaded, samples are available and can be assigned with the (Sample) Knob.

3 Projects & Tracks

SAVING A PROJECT

1. Press (Screen), the multi-functional screen encoder. The main menu will be displayed. Turning (Screen) will navigate the menu.
2. Turn (Screen) to highlight 'File' in the menu.
3. Press (Screen) to select the highlighted 'File' option and to open the submenu options.
4. Turn (Screen) to highlight 'Save Project' or 'Save Project As' in the menu.
 - Save is typically used to save an existing, named project after editing or changing the project.
 - Save As is typically used to save the project as an additional newly named project. The naming menu is presented to apply a name. This is usually performed for the first save of a project even if 'Save' is selected.
5. Press (Screen) to select the highlighted 'Save Project' or 'Save Project As' option and open the project browser window.
6. In the projects folder, Press [Save]. If 'Save Project As' function is applied, the naming utility window will open to allow a new name to be edited. If a name already exists in the location, a suffix will be added.
7. If naming option is presented, set a name or press [Auto Name] dynamic button to automatically create a project name. Press [Confirm] dynamic button to accept and save with the name edited.
8. The project is saved and will be indicated in orange text in the browser.







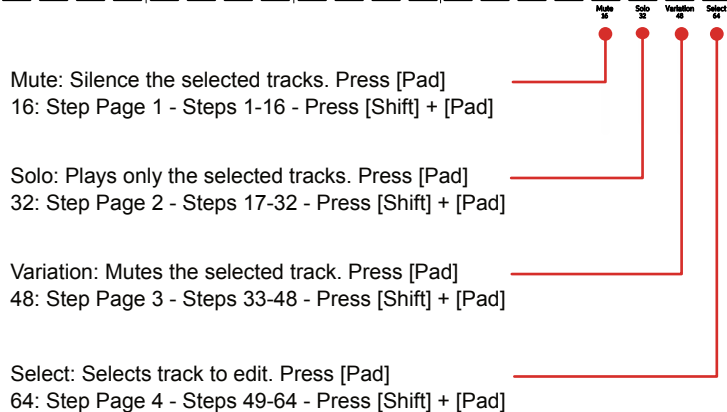
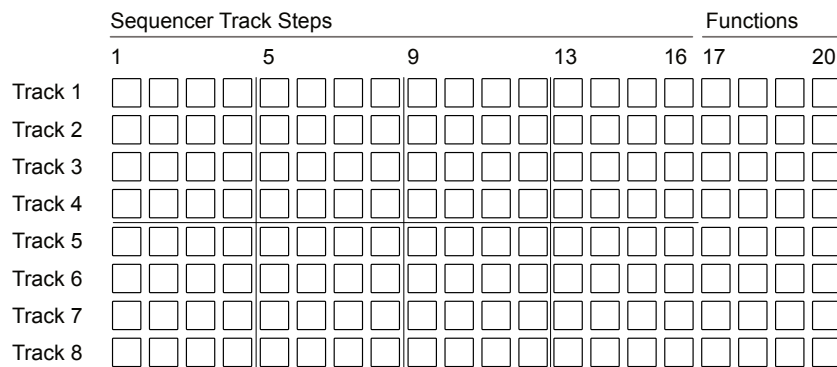



Play+ also automatically saves the currently active project every time a pattern is stopped by pressing the dynamic screen button, [Stop].

3.2 The Grid Overview.

The grid consist of 8 rows of 20 columns of pad buttons. The function of the pads changes depending on the mode selected. Sequencing mode enables sequencing of steps where each row represents a track. The first 16 columns left to right represents steps. Rows represent notes when in piano roll view mode. The last 4 right columns represent function pads, for mute, solo, variation and to select each track. Also the function pads when in View Mode, can operate as a keyboard or pad style note input controller.



Sequencer - 8 x 16 Grid Pad Colors

-  Off. Step is empty and does not trigger any event. Tap [Pad].
-   White for Sample / Violet, Yellow, Green for Synth. Active note event. Tap [Pad].
-  
-  Blue. Selected, note event step. Hold [Shift] + [Pad].
-  Dim Blue. Selected, empty step. Hold [Shift] + [Pad].
-  Orange. Playhead on currently active step for a track. [Play].
-  Red. Playhead on currently active step - Live Rec Mode. [Play].
-  Pink. Root Note Indicator - Piano Roll View Mode. Hold [View].

3 Projects & Tracks

3.3 Track Structure Overview.



NOTES

Play+ has 16 tracks, 8 for MIDI / Synths and 8 sample tracks, each of which can be configured with unique step patterns made up of one or more sample combinations. Tracks are structural elements represented by pad rows that operate in parallel. Each track can have different settings and can consist of up to 64 steps. A set of control functions are available, accessed using the last 4 pad columns on the right, which includes mute, solo, variation and select.



Rows represent 8 tracks (example sample tracks)



Track Functions - 8x4 Grid Pad Colors. Default mode.

-  Green. Mute, Solo, Variation, Select Function selected. Tap [Pad].
-  Dim Green. Function available, not selected.

Track Length - 8x4 Grid Pad Colors - Hold [Shift] to Select.

-  Off. Step count page not selected. [Shift] + [Pad]
-  Green. Step Page Currently Active. Hold [Shift] + [Pad].
-  Dim Green. Available Step Page, Not currently selected. Hold [Shift] + [Pad]

View Mode - 8x4 Grid Pad Colors - Press [View]

-  Notes. Available keyboard style notes for input. [View] to select.

View Mode sets the function pads as a chromatic style keyboard layout where the pads allow manual notes to be entered.

Playback Direction, Default is Forward - Press [Play]



Tracks will play through the defined step length by default, forwards. Playback will then loop back to play from the start to end. Tracks play on loop.

Function rows are lit green for sample audio tracks and purple when in MIDI / Synth mode.

3.4 Track Selection.

One or more tracks can be selected using the function option pads. This is particularly important when editing specific track parameters and when using perform mode. Parameters may not be able to display an absolute setting if multiple tracks are selected. Also adjustments made when multiple tracks are selected will adjust the setting relative to each track's current value. When no track is selected, generic editing is performed.

SELECTING AND EDITING A TRACK

1. Ensure sequence mode is active to allow selection of the 8 tracks. Ensure perform mode is off.
2. Tap the [Select] Pad, column 20, last on the right for the respective track to select. Tracks are represented by rows. Multiple tracks can be selected. Tapping a pad toggles selection on or off.
3. The selected function pad will illuminate bright green, other deselected pads dimmed green. Function pads are purple for MIDI / Synth tracks. Also steps for the track will illuminate blue for note steps and dimly lit blue for empty steps.
4. Any edits to parameters will now be applied as a relative adjustment to any of the tracks parameters original value.
5. Selecting an individual step will exit multi track selection mode.

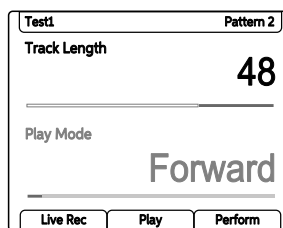

Individual parameter selection with a track. Absolute value is displayed and can be edited.

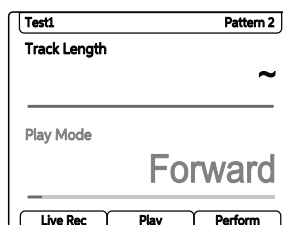

Where multiple, different parameter values exist, i.e. multiple tracks, the ~ tilde symbol is presented. Any parameter adjustments will change all values relatively from the original value, e.g. +1, +2, while the tracks are selected.

3 Projects & Tracks

3.5 Track Step Length.

NOTES

Track lengths can be set between 1 and 64 steps. Each track can have its own independent steps length which allows polyrhythms, polymeters and interesting combinations. The 8x16 pads represent each step length page and the total length is accessed across 4 step pages, each with 16 steps. The overall pattern length is determined by the longest track length.

QUICKLY EXTENDING AN INDIVIDUAL TRACK LENGTH

1. In sequence mode the track length for each of the 8 tracks can be set to up to 64 steps in length. Ensure perform mode is off.
2. Hold [Shift] + [Pad] for one of the 4, far right side columns 17, 18, 19, 20 to increase the step length. Each of the columns represents the step length pages, each with 16 steps. Columns are green for sample tracks and purple for MIDI / Synth tracks.
3. The brightly lit green pad is the currently selected page. The selected page allows step editing on the 16 pad columns left to right.
4. The dimly lit green pad is an active page of steps that will play. These are not currently selected for editing but will play in sequence.
5. The playhead cursor on the grid will be displayed only on the active track step page.

Example:

Track 1; 64 Step length active. Page 1 - Steps 1-16 Selected for pattern pads.

Track 2; 48 Step length active. Page 3 - Steps 33-48 Selected for pattern pads

	Page	1	2	3	4
	Steps	1-16	17-32	33-48	49-64
Track 1		□	□	□	□
Track 2		□	□	□	□

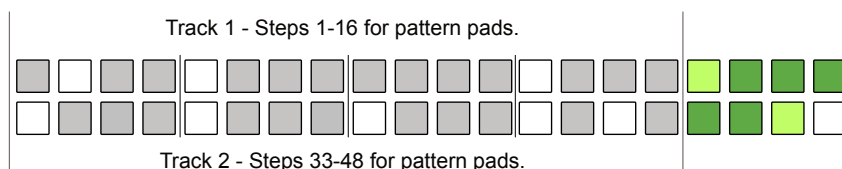

Play+ also has a dedicated track length control parameter which operates on any selected tracks. This will allow a finer adjustment of track length even down to single step resolution.

■ FINE ADJUSTMENTS OF TRACK LENGTH

1. The track length for each of the 8 tracks can be adjusted incrementally.
2. Tap the [Select] Pad, column 20, last on the right for the respective track to select. Tracks are represented by rows. Multiple tracks can be selected to edit. Tapping a pad toggles selection on or off.
3. The selected function pad will illuminate bright green, other deselected pads dimmed green. Also steps for the track will illuminate blue for note steps and dimly lit blue for empty steps.
4. To edit the track length. Tap (Track Length) knob and ensure the parameter is visible and active at the top of the display screen:-
 - With only one track selected, Turn (Track Length). The absolute value is changed to set the step length for the track in 1 step increments. Use [Shift] + (Track Length) for 4 step resolution changes to the value.
 - With multiple tracks selected, Turn (Track Length). The relative value is changed to adjust the step length for each track relative to each track's original value in +/- 1 step increments. Use [Shift] + (Track Length) for +/- 4 step resolution changes to the value.
5. The step pages will change accordingly to the setting applied. To view the active pages, Hold (Shift) in sequence mode.
6. The playhead cursor will display only on active track step pages.

Relative Track Length Examples

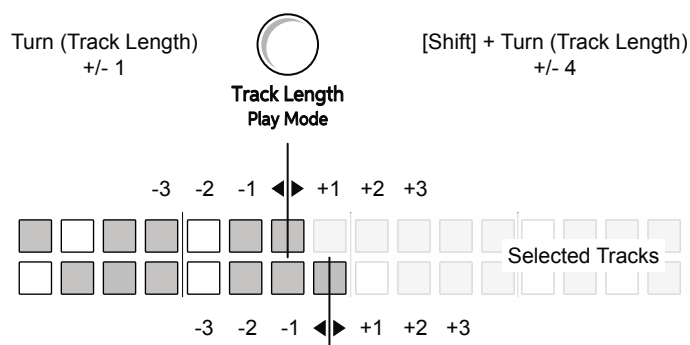

3 Projects & Tracks

3.6 Copy / Paste Steps Page and Tracks.

NOTES

Track length can be up to 64 steps managed across 4, 16 step pages. Extending length only affects empty steps but the note steps can be copied from one page to another if required. Tracks and their steps and parameters can also be copied. Pad colors are dependant on the sample, MIDI or Synth mode. Examples demonstrate sample tracks.

■ COPYING A TRACK STEP PAGE

1. In sequence mode hold [Shift] to view the active and selected step pages for each track.
2. To copy a track step page, Keep Hold [Shift] + [Pad] for the step page to copy. The pad will be one of the 4 right side pads lit green.
3. While still holding [Shift] + [Pad] for the source page, Tap [Pad] for the destination page to copy into. This pad will be one of the other 4 right side pads lit green.
4. All of the steps from the source page will be copied to the destination. Pages can be copied across pages on the same track or onto other pages of other tracks.

■ COPYING ENTIRE TRACKS

1. Press the [Select] Pad for the track to select. Tracks represented by grid pad rows. Multiple tracks can be selected. Bright green pads for audio and bright purple for MIDI / Synth Mode indicate selected tracks.
2. To copy the selected tracks, press [Copy].
3. Deselect any selected tracks. Press the [Select] Pad for any selected tracks to deselect it. Dim green / purple indicates unselected tracks.
4. Press the [Select] Pad for the destination track row to copy into. If multiple tracks were copied they will be pasted in the same order below.
5. Press [Shift] + [Paste]. The source tracks including notes and parameters will be copied. Any existing note and parameter data is overwritten when pasting. Copying between Audio and MIDI tracks is possible

Quick Copy: Note that quick copy can operate for steps, step pages, Patterns and Variations. Quick copy is performed by keep holding the source [Pad] for about half a second + Press [Pad] for any destination pads. Pads will flash blue twice when copied to the clipboard and when pasted.

3.7 Mute & Solo Tracks.

Columns 17 and 18 in the function section of the pads represent the mute and solo functions. Mute allows one or more tracks to be silenced. Solo operates opposite to mute. Solo will ensure only selected tracks will be audible. These are useful features when performing improvisations and developing live sessions by controlling the arrangement. Both operate in sequencing and perform modes.

Function pads are green for sample tracks and purple for MIDI / Synth tracks. Examples demonstrate sample tracks.

■ MUTING / UNMUTING A TRACK

1. Tap the [Mute] Pad, column 17, on the right function pads for the respective track. Tracks are represented by rows. Multiple tracks can be selected. Tapping [Mute] toggles mute on or off.
 - An unmuted track is audible. The mute pad is lit dimmed green.
 - A muted track is silenced. The mute pad is lit bright green.
 - A muted track, when exported is silent.
 - CC/PC Messages in MIDI Mode cannot be muted

■ SOLO / UNSOLO A TRACK

1. Tap the [Solo] Pad, column 18, on the right function pads for the respective track. Tracks are represented by rows. Multiple tracks can be selected. Tapping [Solo] toggles solo on or off.
 - Only soloed tracks are audible. The solo pad is lit bright green. Any other, un-soloed track is muted.

3 Projects & Tracks

3.8 Master Volume.

NOTES

Master Volume is a global setting that controls the output audio level of Play+. The Master Volume is independent of any track or project and controls the audio heard on the 'out' connector located on the rear of Play+. Take care when using headphones as the output can be initially loud.

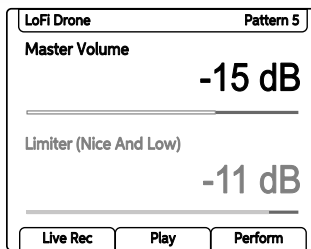

Turn (Master Volume) to adjust the global output volume in 0.5dB iterations. The range is -inf dB to +12dB.

ADJUSTING MASTER VOLUME

1. Tap (Master Volume) to select the parameter and display the values.
2. Turn (Master Volume) to adjust the volume level between -inf dB to +12dB. The adjustment will be in 0.5dB iterations. As a tip, with the Master Volume selected and in focus use the (Screen) knob instead of the parameter knob. The screen knob which has detents for a more precise feel to the control.
3. Hold [Shift] + Turn (Master Volume) to adjust the volume level in 6dB iterations.

USING MASTER VOLUME TO CUTOFF AUDIO TAIL

1. This process is used when an audio tail continues at the end of a pattern. Press [Stop] to stop playback
2. Tap (Master Volume) to immediately cutoff any audio decay tail of the patterns samples.

3.9 Introduction to the Master Limiter.

A limiter is a dynamic processor typically located at or near the end of an audio chain. A limiter's purpose is to tame or control volume levels to avoid clipping, retaining the audio level integrity and also to manage perceived loudness. It does this by reducing the gain when a threshold is exceeded essentially limiting the audio output level.

A series of limiter presets are available from the Master FX menu, selected with [Shift] + [Master FX]. The presets also include options to use a sidechain on the limiter. A sidechain uses an alternative audio signal to trigger the limiter. The threshold is the only adjustable parameter in Play+ and is controlled with the limiter parameter knob.

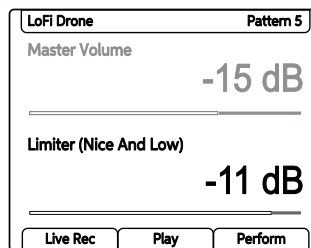

With limiter selected, Turn (Limiter) to adjust the threshold in 1dB iterations. The range is -92dB to 0dB.

3 Projects & Tracks

3.10 Tempo.

NOTES

The overall global tempo of the project can be set between the defined range of 10 - 400 BPM. Note that the MIDI clock input may also control the Play+ global tempo. Equally Play+ can be a master clock for other MIDI devices. Tempo can also be set per track, relative to the global tempo in multiples or divisions.

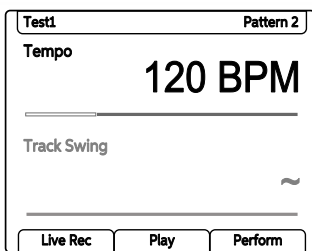

Tempo Swing

Turn (Tempo) to adjust the global tempo. Ensure no track is individually selected otherwise track tempo will be adjusted.

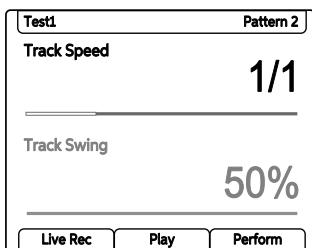

Tempo Swing

Select one or more tracks to adjust the track speed with respect to the global tempo. Turn (Tempo) to adjust the track tempo.

Track Tempo Divider / Multiplier Options

Pause	1/16	1/8	1/6	1/4	1/3	1/2	2/3
1/1	3/2	3/2	2/1	3/1	4/1	6/1	8/1

1/1 Default for all tracks i.e. equals global tempo.

Examples and Notes:

Global Tempo 120 BPM, Track 1 Tempo multiplier 2/1. Track 1 will play twice as fast as other tracks i.e. 240 BPM. Track 1 will play a 16 step pattern twice for every 16 step cycle as other tracks.

Global Tempo 120 BPM, Track 1 Tempo divider 1/2. Track 1 will play at half the speed i.e. 60 BPM of the other tracks. Track 1 will play 8 steps of pattern where other tracks play 16 steps.

Global Tempo 120 BPM, Track 1 Track Tempo 'Pause'. The Paused track playhead will stop on the active step. This would be step 1 when initially pressing [Play]. This has several uses, but one example is that when a track is paused, the note step samples can be played manually by holding (Screen) + Tapping the note steps.

■ SETTING A GLOBAL TEMPO

1. Ensure no tracks are selected, ie Column 20 [Select] all dimmed green
2. Tap (Tempo) to view the current tempo.
3. Turn (Tempo). Tempo can be adjusted between 10-400 Beats Per Minute. Also turning (Screen) encoder knob will change the tempo when the tempo parameter is selected in view.
4. Any track tempo settings will take the global tempo as a reference.

■ SETTING INDIVIDUAL TRACK SPEED

1. Select a track or multiple tracks to assign a tempo speed, Press [Select] for the pad row that represents the desired track. Selected tracks will be lit bright green.
2. Tap (Tempo) to view the track speed. If more than one track is selected the adjustments are made relative to each of the selected tracks original value. A ~ Tilde symbol will be shown if multiple values exist.
3. The parameter control will be track speed as opposed to the global tempo. Turn (Tempo) to assign a multiplier or divider value to the track. The (Screen) encoder will also change the speed when tempo is selected and in view on the screen.
4. Any track speed settings will use the global tempo as it's reference.

3 Projects & Tracks

3.11 Swing.

NOTES

Swing introduces slight off grid adjustments to some steps to create a shuffle feel in an audio or MIDI pattern. This introduces interest and a more human like groove rather than a rigid on grid structure. Swing can only be added at track level. One or more tracks would need to be selected or select all tracks to add a global swing setting.

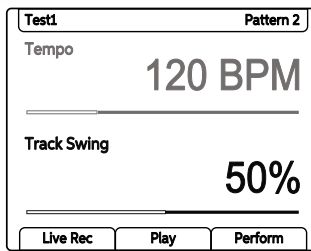

Double tap to select, then Turn (Swing) to adjust the track swing %. Ensure at least one track is selected. A dash '-' will indicate no track is selected in the parameter value.

SETTING A TRACK SWING

1. Ensure at least one track is selected, ie Column 20 [Select] will be lit bright green for selected tracks. Select all tracks to set a global swing to all tracks if required.
2. Tap (Tempo) to view the current tempo and swing.
3. Double tap (Swing) to select the swing parameter in focus. Also pressing the left screen buttons will switch between tempo and swing parameter selection.
4. Turn (Swing). Also turning (Screen) encoder knob will change the swing value when the swing parameter is selected in view.
 - Swing can be adjusted between 25% - 75%.
 - The default is 50% i.e. no swing applied.
 - 25% will push steps forward / early.
 - 75% will pull steps delay / late.
 - The playhead cursor will indicate the swing applied in its visual behaviour.

3.12 Play Mode.

Normal playback of a pattern including all tracks is to play steps forwards in sequence, left to right. Play modes allow the playback step sequence to be changed for audio and MIDI tracks. This gives the ability to remix and shuffle arrangements. There are 35 play modes, each of which will determine the order of the steps when playing a pattern. Play modes consist of classic, pre-defined modes as well as custom modes.

SELECTING A PLAY MODE FOR A TRACK

1. Ensure at least one track is selected, ie Column 20 [Select] will be lit bright green for selected sample tracks, violet for MIDI/Synth tracks.
2. Tap (Track Length) to view the track length and play mode options.
3. Double tap (Play Mode) to select the play mode option in focus. Also pressing the left screen buttons will switch between track length and play mode selection.
4. Turn (Play Mode). Also turning (Screen) encoder knob will change the options when the play mode parameter is selected in view. Default, normal play mode is 'Forward'.

Default Play Mode: Forward

Each Track will play through the defined step length by default, forwards. Playback will then loop back to play from the start to end or move to the next pattern if playing a chain. Tracks play on loop.

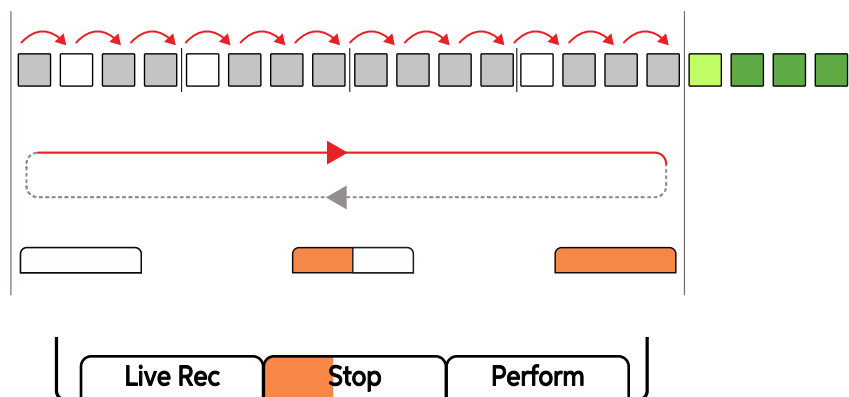

Play progress bar will follow the duration of the longest track pattern. This will not show any progress if any track speed is set to pause.

3 Projects & Tracks

Play Modes.

A quick reference summary of play modes available. Descriptions are for guidance and don't represent an exact per step description. The actual playback behaviour may depend on track length in some play modes. Play modes will determine the step behaviour and order of playback, irrespective of whether notes exist or not.

Play Mode	Description
Forward	Default play mode. Starting at step 1, plays through to the last step. Plays all steps to the end, then restarts from step 1 and continues to loop play.
Reverse	Starting at the last step, plays through to the first step. Plays all steps in reverse, end to start, then restarts from the end and continues to loop play.
First Steps	Repeats first 4 steps instead of 4 to 8. Shuffles steps in playback order later in the pattern especially when extending step pages.
Go Go	Similar to first steps but includes reversing playback across sections.
2stepper	Plays only the first 8 steps from the start, then reverses on the 9 th step playing backwards to the start. With extended step count pages steps may shuffle, but still only across the first 8.
Thumper	Plays across max 32 steps. Plays forward. Plays the step 7 twice, skipping step 8. Cycle repeats for each set of 8 steps, ie doubles 15, skips 16, doubles 23, skips 24 etc.
Doublestep	Plays across max 32 steps. Skips 14 & 16 and instead plays steps 13, 15 & 12. Step 13 is doubled. Steps are shuffled for 25, 26, 27, 29, 32.
Euphoria	Plays across max 32 steps. Skips steps and plays on the start of each bar for first 16 steps, then shuffles first and second step per bar on steps 17-32.
Tristram	Shuffles step forward and backwards playback across only first 1-5 steps irrespective of length of pattern. Shuffle behaviour is changed based on the total pattern length despite only playing up to the first 5 steps.
Funkster	Plays only steps 1, 3 & 5 forwards and backwards. The behaviour of the 3 step shuffle is based on the overall track length.
Trigger	Plays across max 32 steps. Shuffles playback across only steps 1, 2, 4, 5, and 14 or 30 depending on the total step length of the track.
Hattrick	Plays across max 16 steps. Shuffles playback across only steps 1, 3 & 5, and will also include step 2 if the track length is set greater than 16.
Averidger	Plays across max 16 steps. Shuffles playback back and forth across only steps 1, 2 & 5.
Reorganizer	Plays across max 16 steps. Shuffles playback back and forth across only steps 1, 2, 3, 4, 5, 8, 12 & 13.
Mashup	Plays across max 16 steps. Shuffles playback back and forth across only steps 1, 2, 5, 7, 9, 10, 11 & 12.
Mirror	Plays across max 16 steps. Playback of each bar played in reverse, i.e. Step 4, 3, 2 & 1, Step 8, 7, 6 & 5 etc through the 16 steps.
Clublab	Plays across max 16 steps. Shuffles playback back and forth across only the first 5 steps.
Clubdub	Plays across max 16 steps. Similar playback to Clublab but slight variation on the latter steps in the pattern.
Repeater	Plays across max 16 steps. Repeats on step 5 and on step 1, alternating in 1 bar sections throughout the 16 steps.

NOTES

Play Mode	Description
The End	Plays across max 16 steps. Shuffles playback back and forth across only steps 1, 2 & 5.
Tripler	Plays across max 16 steps. Shuffles playback back and forth around only steps 1 & 2 plus the addition of step 5.
Breaker	Plays across max 16 steps. Shuffles playback back and forth around only steps 1, 2 & 5 plus the addition of step 4.
Stomper	Plays across max 16 steps. Shuffles playback back and forth around only steps 1, 2, 4, 5, 6, 10 & 16 on the last step.
Tetris	Plays across max 16 steps. Shuffles playback back and forth through the cycle of only steps 5, 2 & 1.
Recognizer	Plays across max 16 steps. Playback of only steps 1 & 5 then shuffles across steps 2, 5 & 1.
Varibeat	Plays across max 16 steps. Playback cycles within only steps 1, 2, 3, 5 & 9.
Complicator	Plays across max 16 steps. Playback cycles within only steps 2, 3, 4, 5 & 9.
9th Grade	Plays across max 16 steps. Playback alternates only between steps 9 & 2.
Irregulario	Plays across max 16 steps. Playback starting on step 9 and shuffling back and forth across steps 1-5.
Stepper	Plays across max 16 steps. Playback shuffles back and forth across steps 1-9, skipping step 7.
Revizor	Plays across max 16 steps. Playback starts and alternates between step 1 and backwards through 3 steps 15, 14, 13 then 12, 11, 10 and 8, 7, 6 finishing on 4, 3, 2.
Baker	Plays across max 16 steps. Playback shuffles back and forth across 1-5.
Lab	Plays across max 16 steps. Playback shuffles back and forth across steps 1, 2 & 5 and adds step 7 in the cycle.
Dub	Plays across max 16 steps. Similar to Lab. Playback shuffles back and forth across steps 1, 2 & 5 only.
Pixelizer	Plays across max 16 steps. Playback shuffles back and forth across steps 1, 2, 3, 4, 5, 7, 8, 9 & 16 only and 13 on the last step.

3 Projects & Tracks

3.13 Exporting Tracks.

NOTES

A number of export options exist in Play that allows bouncing of audio files as an output to the microSD card. The Export option is found in the main menu under the 'File' functions. Muted tracks are exported as silent.

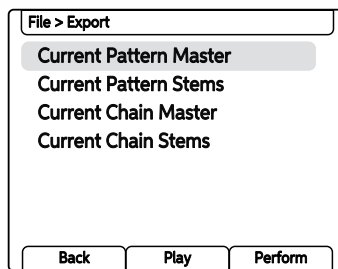

Menu	Option	Description
File > Export	Current Pattern Master	Exports a single stereo master file of the current pattern. Export is after saturation but before the master sound FX.
File > Export	Current Pattern Stems	Exports 10 Audio stems from the currently selected pattern. This consists of 8 tracks, delay and reverb send effect stems. Export is at the mixer stage, before the limiter.
File > Export	Current Chain Master	Exports a single stereo master file of the current chain of patterns. Export is after saturation but before the master sound FX.
File > Export	Current Chain Stems	Exports 10 Audio stems from the currently selected pattern chain. This consists of 8 tracks, delay and reverb send effect stems. Export at the mixer stage, before the limiter.

Files that are exported are stored on the microSD card in the 'Export' folder. The folder may not be present at the outset but is created when files are exported. Files are named after the track or effect, i.e. Track1, Delay or master for single master output files. A folder named after the project will be created for the exports.

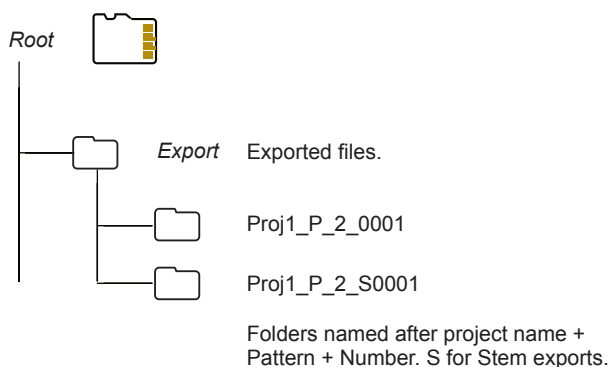

EXPORTING TRACKS

1. Press (Screen), the multi-functional screen encoder. The main menu will be displayed. Turning (Screen) will navigate the menu.
2. Turn (Screen) to highlight 'File' in the menu.
3. Press (Screen) to select the highlighted 'File' option and to open the submenu options.
4. Turn (Screen) to highlight 'Export' in the menu.
5. Turn (Screen) to highlight the export option required. These will export either a single master file for the pattern or chain or individual track stems along with the reverb and delay sends as individual tracks.
6. Press (Screen) to execute the export option selected. The tracks are exported to the microSD card and if one doesn't exist an 'Export' folder is created. Each export will create a unique export folder, named by the project name, pattern sequence number(s) and an export sequence number. Files are named as Track1, Track 2 etc.

4

Parameter Summary

Play has 15 touch sensitive, endless rotary knobs. Touching the knob selects the primary parameter and turning the knob adjust the parameter value. The select and adjust process ensure that parameters are set up ready to place in a pattern or edited after placement into steps. Each of the knobs controls two parameters where tapping or double tapping the knob switches selection between the two. The behaviour of the double tap feature can be changed in the main menu settings. The left screen buttons and screen knob also can toggle between parameters and change the value. Some parameters control global or track based functions while the majority of parameters set the step parameter value. It should be noted that when in MIDI / Synth Mode some of the parameter knobs take on MIDI or Synth specific functions. In MIDI Mode control knobs transition to adjustment of continuous control and program change

messages as well as applying parameters to MIDI notes. When in Synth mode and also with a synth device selected some control knobs switch to adjust defined synth parameters. A synth patch has 6 macros that are configured for direct control of synth parameters by using these defined knobs. These of course are not labelled as MIDI or Synth parameters on the hardware but do reflect the parameter on the displayed screen label. Developing patterns with a variety of parameter settings is a core part of sound design and helps create musical interest and progressions. Parameters can be set at a step level not just per track. Where multiple values exist for a parameter the display may show a '~' symbol in place of the absolute parameter value. This section is the first introduction to all parameters and serves more as a quick reference of the audio parameter features and gives an overview of each.

4 Parameter Summary

4.1 Parameter Overview.

NOTES

The 15 rotary knobs are used to set the parameter values. Each knob controls two parameters. These are labelled under the knob. Some functions change when in MIDI / Synth Mode, indicated in *Italic text* in the table below to reflect a MIDI or a Synth parameter.

Parameter	Primary / Secondary	Description
Master Volume	Primary	Controls the master volume level for the audio output.
Limiter	Secondary	Dynamic processor to control volume levels
Tempo	Primary	Global tempo. Also sets track speed.
Swing	Secondary	Generates a natural shuffle to a track.
Track Length	Primary	Adjusts number of steps in the track up to 64
Play Mode	Secondary	Determines the order of the track steps
Note	Primary	Tunes the sample note in semitone steps
Microtune	Secondary	Tunes sample pitch in cents
Volume	Primary	Adjusts the sample volume level / <i>Velocity</i>
Panning	Secondary	Adjust the sample panorama position L-R / <i>Pitch Bend</i>
Filter Cutoff	Primary	Adjusts the Filter Cutoff Frequency / <i>CC or Macro</i>
Resonance	Secondary	Adjust the Filter Resonance amount / <i>CC or Macro</i>
Sample	Primary	Selects a sample from the folder / <i>Port Chan or Synth</i>
Folder	Secondary	Sample folder from where to choose / <i>PC or Patch</i>
Sample Start	Primary	Start of sample play with respect to length / <i>Chord</i>
Sample End	Secondary	End position of sample play with respect to length
Sample Attack	Primary	Envelope attack, % of sample fade in / <i>CC or Macro</i>
Sample Decay	Secondary	Envelope decay, % of sample fade out / <i>CC or Macro</i>
Reverb Send	Primary	Audio amount sent to the reverb effect / <i>CC</i>
Delay Send	Secondary	Audio amount sent to the delay effect / <i>CC</i>
Overdrive	Primary	Overdrive amount applied to the sample / <i>CC or Macro</i>
Bit Depth	Secondary	Bit depth setting / <i>CC or Macro</i>
Repeat Type	Primary	Sets the number of repeats on the step
Repeat Grid	Secondary	Sets the density for the repeats set on the step
Chance	Primary	Determines the probability of an action occurring
Action	Secondary	Sets the action to occur after a step trigger
Randomize	Primary	Strength of randomization applied.
Randomize Type	Secondary	Determines what is affected by the randomization
Move	Primary	Moves steps across the grid in 1 step intervals
Micromove	Secondary	Moves steps across the grid in micro intervals

NOTES

4.2 Master Volume / Limiter.

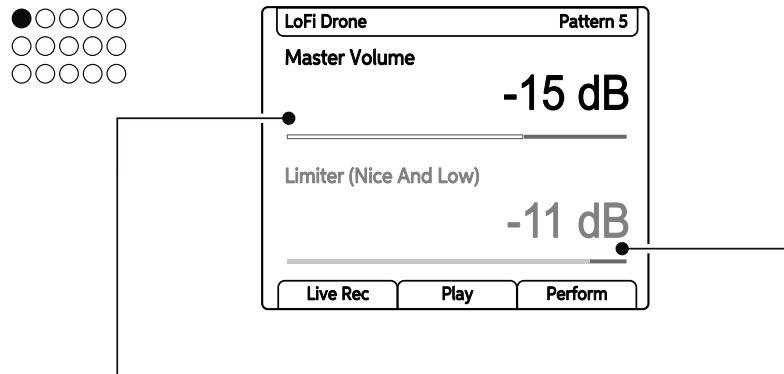

Primary Parameter

Master Volume

Description

Global function that controls the master output volume level. Master output is connected using the rear stereo 'out' 3.5mm socket.

Range / Options

Range is -inf dB to 12 dB. Changes are made in 0.5dB steps when turning (Master Volume) and in 6dB increments when holding the [Shift] + Turn (Master Volume)

Other Information

Touch the knob after stopping the sequencer to cut off any currently decaying audio.

MIDI Mode

The Master Volume option is still accessible when in MIDI / Synth mode. This parameter knob is identical both in all modes.

Secondary Parameter

Limiter

Description

Dynamic processor used to control transient levels, avoid clipping and push perceived loudness. Operates as a global function.

Range / Options

Parameter controls the threshold from -92dB to 0dB. The limiter presets are Squishy, Boom, Release Me, Slo Attack, Heavy, Nice And Low, Broken Bones, Squish That Cat, Sidechain Track 1-8.

Other Information

A classic limiter model which reduces the volume levels of any signal that exceeds a threshold. Levels below the threshold are unaffected. Limiter presets are available in the master FX section.

MIDI Mode

The Limiter option is still accessible when in MIDI / Synth mode. This parameter knob is identical in all modes.

4 Parameter Summary

4.3 Tempo / Track Swing.

NOTES

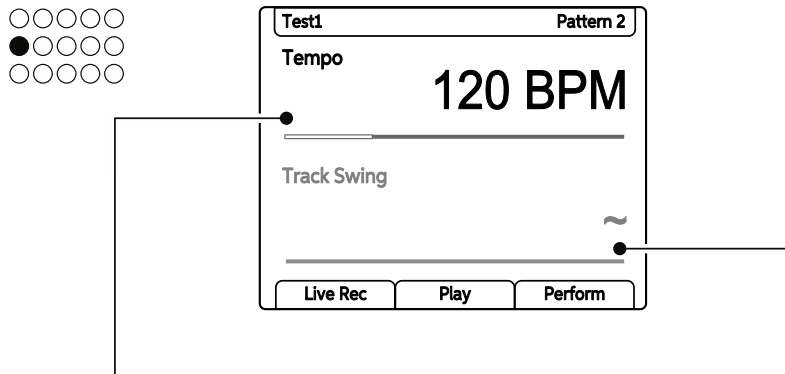

Primary Parameter

Tempo

Description

Multi function parameter for tempo. Default is global tempo for the project. Track speed control when tracks are selected. Manually trigger note steps.

Range / Options

Global tempo range in Beats per Minute is 10 to 400 BPM. Track speed options; Pause, 1/16, 1/8, 1/6, 1/4, 1/3, 1/2, 2/3, 1/1 is default, 3/2, 2/1, 3/1, 4/1, 6/1, 8/1. Track speed takes reference from global tempo.

Other Information

Tempo can also be governed by any external MIDI lead device if set up as such. Paused tracks can have the steps manually triggered by pressing the (Tempo) knob.

MIDI Mode

The Tempo option is still accessible when in MIDI / Synth mode. This parameter knob is similar in all modes, although tempo may represent externally controlled tempo if an external clock is the primary lead.

Secondary Parameter

Track Swing

Description

Swing applies a shuffle effect to give a more natural feel to each track.

Range / Options

A setting of 50% is default and applies no swing. Range is 25% to 75%. Values <50% apply a swing for notes to play early and >50% plays late.

Other Information

Applied to audio and MIDI tracks. The swing applied is visible in the playhead behaviour. Select all tracks to apply a global swing value.

MIDI Mode

The Swing option is still accessible when in MIDI / Synth mode. This parameter knob is similar in all modes.

4.4 Track Length / Play Mode.

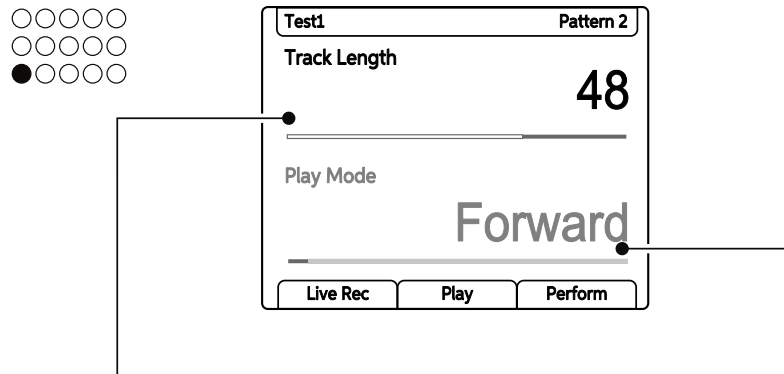

Primary Parameter

Track Length

Description

Sets the number of steps in a track up to 64 steps. Steps are presented in pages of 16 steps, up to 4 pages accessible by function buttons.

Range / Options

The range of steps per track is 1-64. Each page presents 16 steps. Hold [Shift] to view available pages.

Other Information

Length is determined on a track by track basis or for all tracks together and syncopated and polyrhythms can be created

MIDI Mode

The Track Length option is still accessible when in MIDI / Synth mode. This parameter knob is similar in all modes.

Secondary Parameter

Play Mode

Description

Select one of the classic and custom play modes which determines the order of the track steps playback.

Range / Options

Up to 35 play modes can be selected for both audio and MIDI tracks.

Other Information

Play mode is determined on a track by track basis or for all tracks together and helps to create interesting and unusual rhythms.

MIDI Mode

The Play Mode option is still accessible when in MIDI / Synth mode. This parameter knob is similar in all modes.

4 Parameter Summary

4.5 Note / Microtune.

NOTES

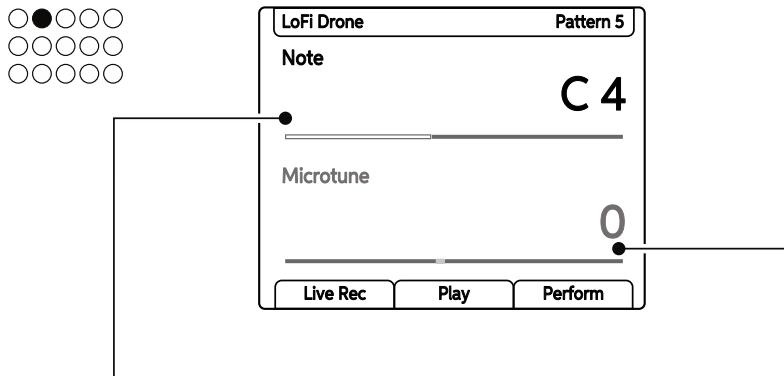

Primary Parameter

Note

Description

Sets the pitch note for the sample.

Range / Options

Adjustments across the note range are made in semitones, 1 note per iteration when turning (Note). To change in octave iterations, hold [Shift] + Turn (Note).

Other Information

Play+ assumes the note 'C4' as the default for the sample and adjustments would therefore reference this expected default.

MIDI Mode

The Note parameter refers to MIDI Note when in MIDI Mode. .

Secondary Parameter

Microtune

Description

Adjust pitch in cents.

Range / Options

Range is -100 to 0 to +100 cents.

Other Information

Play+ assumes the note 'C4' as the default for the sample and adjustments would therefore reference this expected default.

MIDI Mode

The Microtune knob changes to Pitchbend when in MIDI Mode and controls the output MIDI messages over a -100 to +100 range.

NOTES

4.6 Volume / Panning.

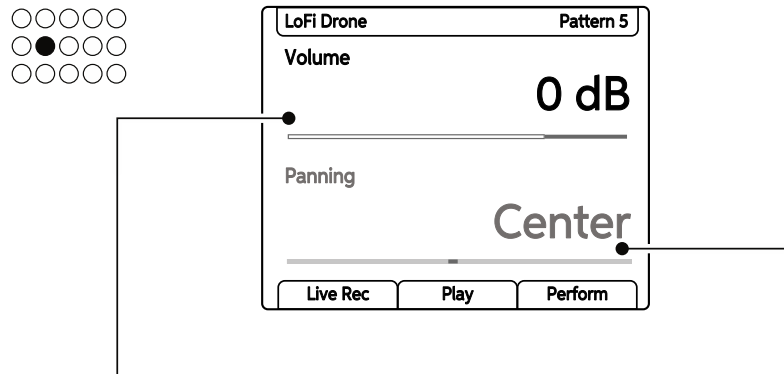

Primary Parameter

Volume

Description

Volume function that controls the sample volume level. 0 dB refers to the volume level of the original sample.

Range / Options

Range is -inf dB to 12 dB. Change are made in 1 dB steps when turning (Volume) and in 6dB increments when holding the [Shift] + Turn (Volume)

Other Information

MIDI Mode

This Knob is reassigned when in MIDI Mode. Volume switches to MIDI Note Velocity over a 0-127 range and default at 100.

Secondary Parameter

Panning

Description

Adjusts the panoramic spread across the stereo field.

Range / Options

Range is 100L - Center - 100R. Changes in increments of 1 when turning (Pan) and in increments of 10 when using [Shift] + Turn (Pan).

Other Information

MIDI Mode

The Knob is reassigned when in MIDI Mode. Panning switches to MIDI Note Length applied with respect to step length.

4 Parameter Summary

4.7 Filter Cutoff / Resonance.

NOTES

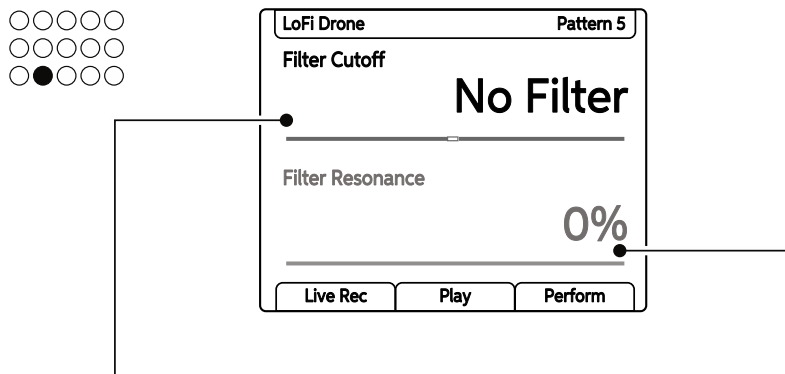

Primary Parameter

Filter Cutoff

Description

DJ Style low pass and high pass filter. Low pass filter attenuates frequencies above the cutoff and high pass filter attenuates frequencies below.

Range / Options

Range is 100-0 anticlockwise - low pass filtering. Turning clockwise 0-100 high pass filtering. Centre position applies 'No Filter' to the sound.

Other Information

Filter can be set per step and using the work step. To filter everything select all tracks.

MIDI Mode

The Filter Cutoff parameter knob changes to control CC Messaging in MIDI Mode. The CC assignments have a default set but these can be reassigned in the main menu. Filter default is CC#74.

Synth Mode

The Filter Cutoff parameter knob changes to control a synth patch macro. The specific parameter will be determined by the patch selected.

Secondary Parameter

Filter Resonance

Description

Adjusts the filter resonance.

Range / Options

Range is 0-100%. Changes in increments of 1 when turning (Resonance) and in increments of 10 by using [Shift] + Turn (Resonance).

Other Information

Filter resonance emphasises the frequency at the cutoff point adding more bite and texture to the sound.

MIDI Mode

The Resonance parameter knob changes to control CC Messaging in MIDI Mode. The CC assignments have a default set but these can be reassigned in the main menu. Filter default is CC#71.

Synth Mode

The Resonance parameter knob changes to control a synth patch macro. The specific parameter will be determined by the patch selected.

4.8 Sample / Folder.

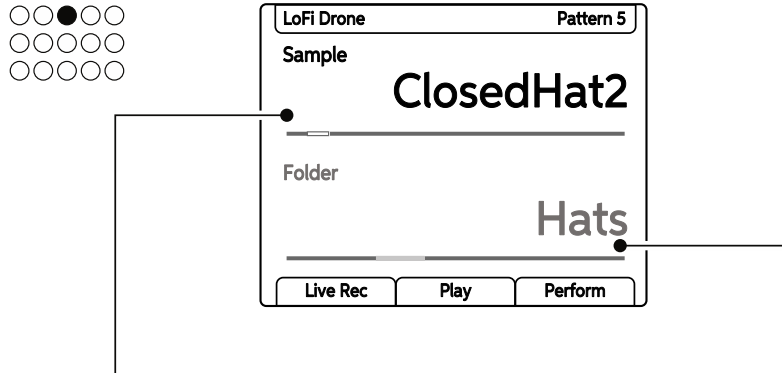

Primary Parameter

Sample

Description

The sample that is selected and used as a steps sound source. Typically would be set in the work step then placed on the grid.

Range / Options

All samples will be available from the sample pool folder selected

Other Information

Sample format will be set within the internal sample engine automatically. Samples must be copied to the sample pool to be accessible.

MIDI Mode

The MIDI Channel is selected by the Sample knob when in MIDI mode. The channel is also assigned with the specific Jack or USB Port.

Synth Mode

The sample parameter knob changes to select one of the three synths. Macro parameters are available for some knobs when a synth is selected.

Secondary Parameter

Folder

Description

The sample pool folder from which to select a sample.

Range / Options

All folders in the sample pool will be available for selection unless a folder is empty. If a folder is empty it will not be visible for selection.

Other Information

Samples and folder must be created or transferred to the sample pool to be selectable. The folder structure and names are critical to some of Play+ advanced options. Sample pack format is preferred.

MIDI Mode

The Resonance parameter knob changes to control PC Messaging in MIDI Mode. Program Change messages change the preset or bank on a destination device.

Synth Mode

The Resonance parameter knob changes to select a synth patch. Synth macro parameters are determined by the patch.

4 Parameter Summary

4.9 Sample Start / Sample End.

NOTES

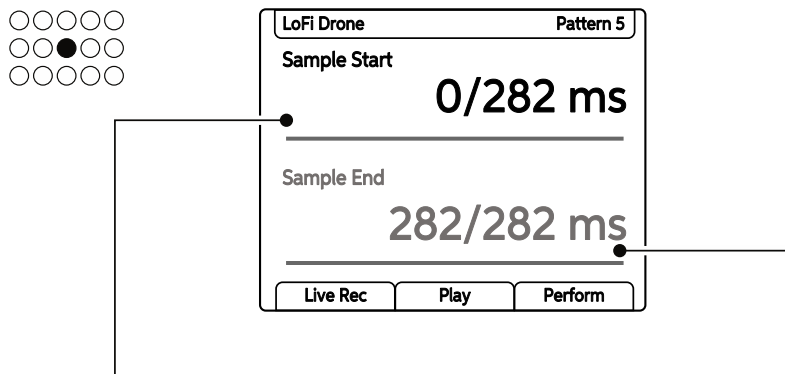

Primary Parameter

Sample Start

Description

Sample start in ms with respect to the full sample duration.

Range / Options

Depends on sample duration. First value in the display is the start position in ms. By default this is 0.

Other Information

The sample start and end are useful in chopping sample slices across pads on the sequencer grid.

MIDI Mode

The Sample Start knob switches to Chord in MIDI Mode. This allows the selection of chords from a library of predefined chord presets.

Synth Mode

The Sample Start parameter knob switches to Chord in Synth Mode. This allows the selection of chords from a library of predefined chord presets.

Secondary Parameter

Sample End

Description

Sample end in ms with respect to the full sample duration.

Range / Options

Depends on the sample duration. First value in the display is the start position in ms. By default this matches the sample duration.

Other Information

Set an end point before the start point to play samples in reverse.

MIDI Mode

Reserved for future use.

Synth Mode

Reserved for future use.

4.10 Sample Attack / Sample Decay.

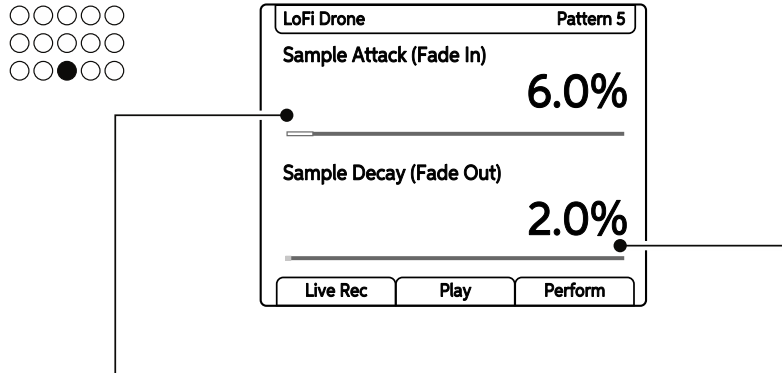

Primary Parameter

Sample Attack

Description

Attack time of the sample start. This would enable a fade in of the audio when the sample is triggered.

Range / Options

Range is 0-100%. Increments of 0.1% are made by turning (Sample Attack) and 1% increments when using [Shift] + Turn (Sample Attack).

Other Information

This part of the envelope is applied at the sample start i.e. Attack phase. The value is set in % as sample duration varies.

MIDI Mode

The Sample Attack parameter knob changes to control CC Messaging in MIDI Mode. The CC assignments have a default set but these can be reassigned in the main menu. Filter default is CC#22.

Synth Mode

The Sample Attack parameter knob changes to control a synth patch macro. The specific parameter will be determined by the patch selected.

Secondary Parameter

Sample Decay

Description

Decay time of the sample end. This would enable a fade out of the audio when the sample ends.

Range / Options

Range is 0-100%. Increments of 0.1% are made by turning (Sample Decay) and 1% increments when using [Shift] + Turn (Sample Decay).

Other Information

This part of the envelope is applied at the sample end i.e. Decay phase. The value is set in % as sample duration varies.

MIDI Mode

The Sample Decay parameter knob changes to control CC Messaging in MIDI Mode. The CC assignments have a default set but these can be reassigned in the main menu. Filter default is CC#75.

Synth Mode

The Sample Decay parameter knob changes to control a synth patch macro. The specific parameter will be determined by the patch selected.

4 Parameter Summary

4.11 Reverb Send / Delay Send.

NOTES

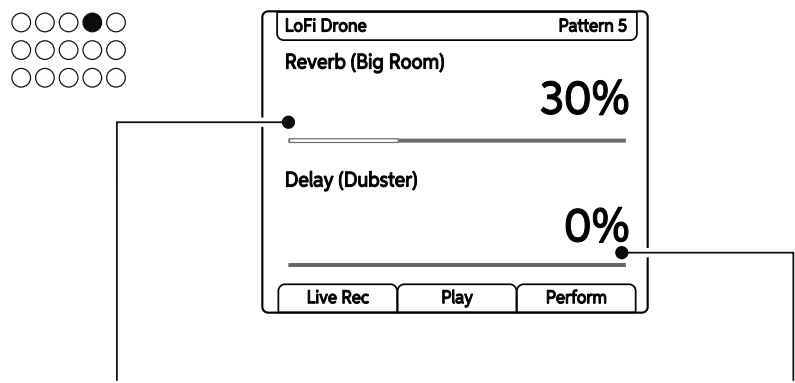

Primary Parameter

Reverb Send

Description

Amount of audio sent to the reverb effect. The Reverb effect itself is located in the Master FX.

Range / Options

Range is 0-100% to govern the audio amount sent to the effect. Turn (Reverb Send) to adjust in 1% increments, For 10% increments use [Shift] + Turn (Reverb Send).

Other Information

Presets are available that assign various characteristics and style to the reverb. This is selected in the Master FX section and the selected option displayed with the parameter.

MIDI Mode

The Reverb Send parameter knob changes to control CC Messaging in MIDI Mode. The CC assignments have a default set but these can be reassigned in the main menu. Filter default is CC#17.

Secondary Parameter

Delay Send

Description

Amount of audio sent to the delay effect. The Delay effect itself is located in the Master FX.

Range / Options

Range is 0-100% to govern the audio amount sent to the effect. Turn (Delay Send) to adjust in 1% increments, For 10% increments use [Shift] + Turn (Delay Send).

Other Information

Presets are available that assign various characteristics and style to the delay. This is selected in the Master FX section and the selected option displayed with the parameter

MIDI Mode

The Delay Send parameter knob changes to control CC Messaging in MIDI Mode. The CC assignments have a default set but these can be reassigned in the main menu. Filter default is CC#19.

4.12 Overdrive / Bit Depth.

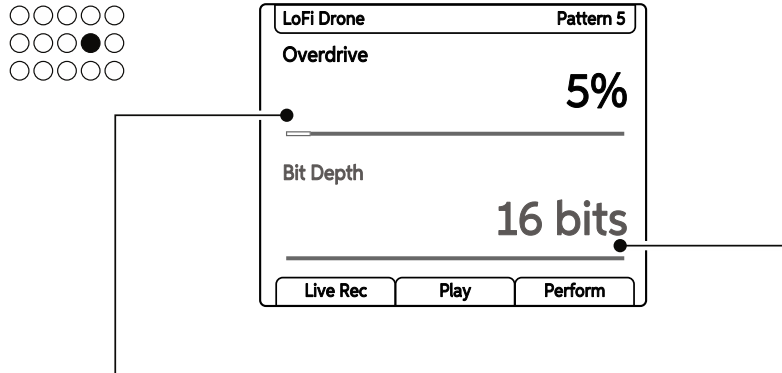

Primary Parameter

Overdrive

Description

Sets the amount overdrive effect applied to the sound.

Range / Options

Range is 0-100% to govern the audio amount applied by the effect. Turn (Overdrive) to adjust in 1% increments, For 10% increments use [Shift] + Turn (Overdrive).

Other Information

Sets the amount of grit and amplification audible in the sound.

MIDI Mode

The Overdrive parameter knob changes to control CC Messaging in MIDI Mode. The CC assignments have a default set but these can be reassigned in the main menu. Filter default is CC#12.

Synth Mode

The Overdrive parameter knob changes to control a synth patch macro. The specific parameter will be determined by the patch selected.

Secondary Parameter

Bit Depth

Description

Playback bit resolution reduction

Range / Options

Range is from 4 bits up to 16 bits.

Other Information

Default is 16 bits which is the normal sample state.

MIDI Mode

The Bit Depth parameter knob changes to control CC Messaging in MIDI Mode. The CC assignments have a default set but these can be reassigned in the main menu. Filter default is CC#13.

Synth Mode

The Bit Depth parameter knob changes to control a synth patch macro. The specific parameter will be determined by the patch selected.

4 Parameter Summary

4.13 Repeat Type / Repeat Grid.

NOTES

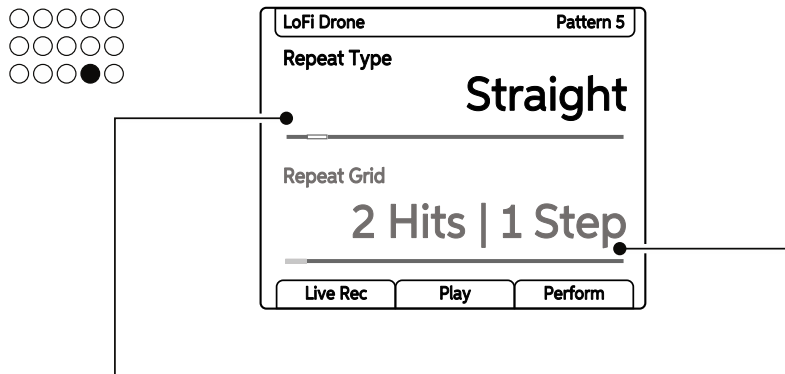

Primary Parameter

Repeat Type

Description

Steps can be set to repeat. The type of ratcheting is selectable from a range of pre-programmed repeat algorithm styles is available.

Range / Options

Off, Straight, Fade, Raise, Pong, Arp Down, Arp Up, Tank, Alien, Echo, Your Crush, Glitter, Effectron, To And From, Round Trip, Octaves, Game Over, Down And Up.

Other Information

Some options are based on tuning. For example the arp will repeat by changing notes.

MIDI Mode

The Repeat Type option is still accessible when in MIDI / Synth mode. This parameter knob is similar in all modes but there may be some contextual difference.

Secondary Parameter

Repeat Grid

Description

Sets the step repetition density. Sets the note trigger with respect to the amount steps in the range.

Range / Options

2 Hits|1 Step, 3 Hits|1 Step, 3 Hits|1 Step, 4 Hits|1 Step, 8 Hits|1 Step, 3 Hits|4 Steps, 4 Hits|4 Steps, 6 Hits|4 Steps, 8 Hits|4 Steps, 16 Hits|4 Steps, 2 Hits|8 Steps, 3 Hits|8 Steps, 4 Hits|8 Steps, 6 Hits|8 Steps, 8 Hits|8 Steps, 16 Hits|8 Steps, 32 Hits|8 Steps

Other Information

Applied to audio and MIDI tracks. If scale filtering is on, the repeated notes are filtered to the currently selected scale.

MIDI Mode

The Repeat Grid option is still accessible when in MIDI / Synth mode. This parameter knob is similar in all modes but there may be some contextual difference.

4.14 Chance / Action.

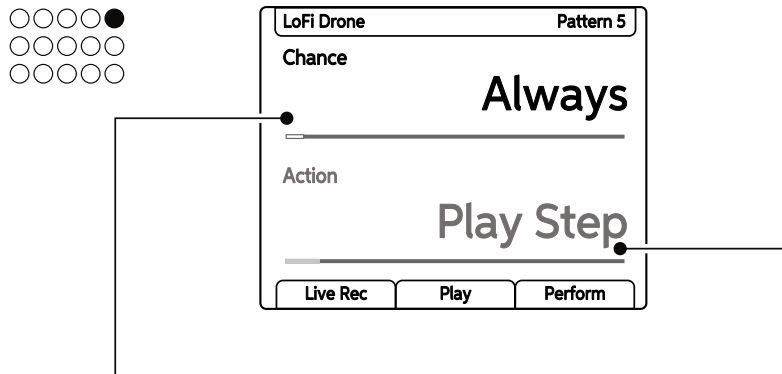

Primary Parameter

Chance

Description

Determines if or when a selected action will occur by setting its probability to execute. The activity to execute is selected as the action.

Range / Options

Always - Executes every step.
 90-10% Chance - % probability event is executed.
 Group with last. Play X / Skip Y, Skip X / Play Y.

Other Information

Operates on audio and MIDI steps. Operates in a non-destructive way for existing steps.

MIDI Mode

The Chance option is still accessible when in MIDI / Synth mode. This parameter knob is similar in all modes but there may be some contextual difference.

Synth Mode

The Chance option is still accessible when in MIDI / Synth mode. This parameter knob is similar in all modes but there may be some contextual difference.

Secondary Parameter

Action

Description

Action to be executed after the step is triggered.

Range / Options

Play Step - default state, play step as normal. Rnd X - where 'X' is the parameter to randomize. Humanize - randomize the micromove.

Other Information

MIDI Mode

The Action option is still accessible when in MIDI / Synth mode. This parameter knob is similar in all modes but there may be some contextual difference.

Synth Mode

The 'Rnd Cutoff CC' option is an additional option available. This will allow chance to be applied to the macro assigned to 'filter cutoff'

4 Parameter Summary

4.15 Randomize / Randomize Type.

NOTES

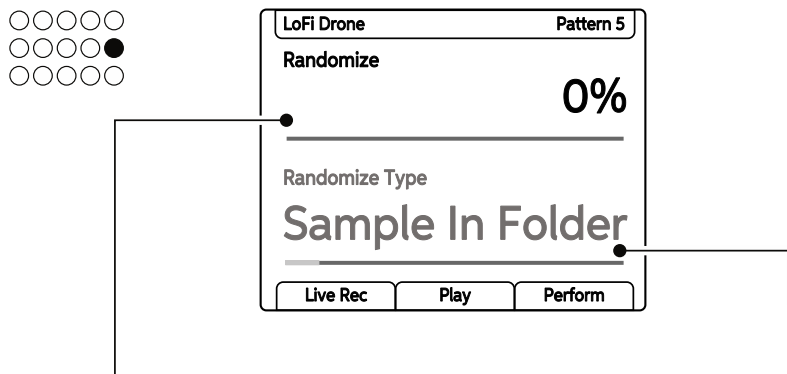

Primary Parameter

Randomize

Description

Strength of randomization. Randomization range for the parameters (set by Random Type) for the selected notes.

Range / Options

Strength between 0-100%

Other Information

Adds movement and variation to a pattern.

MIDI Mode

The Randomize option is still accessible when in MIDI / Synth mode. This parameter knob is similar in all modes but there may be some contextual difference.

Synth Mode

The Randomize option is still accessible when in MIDI / Synth mode. This parameter knob is similar in all modes but there may be some contextual difference.

Secondary Parameter

Randomize Type

Description

Sets which step parameters are affected by the randomization.

Range / Options

Sample in Folder, Sample in Pool, Sample Length, Texture, 1 Octave, 2 Octaves, Volume, Space, Nuke, Duke Nuke.

Other Information

MIDI Mode

The Randomize Type option is still accessible when in MIDI / Synth mode. This parameter knob is similar in all modes but there may be some contextual difference.

Synth Mode

The 'Filter CC/Macro' option is an additional option available. This will allow randomization to be applied to the macro assigned to 'filter cutoff'

4.16 Move / Micromove.

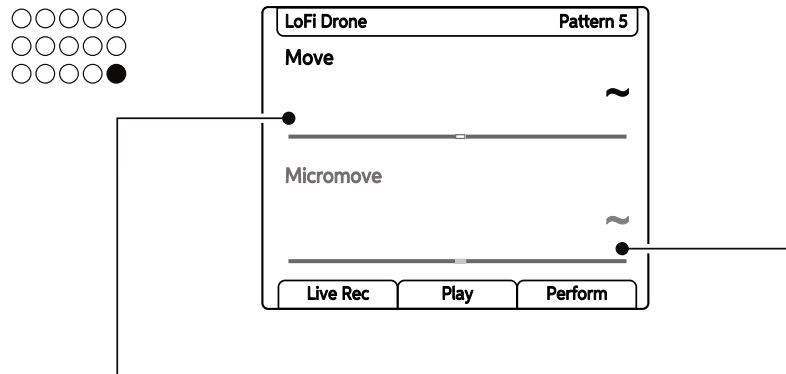

Primary Parameter

Move

Description

Moves select steps left or right on the sequencer grid.

Range / Options

Moves steps early / left or later / right by one step iterations when turning (Move).

Other Information

Allows the cutting and pasting of a selection of steps. Action will overwrite any existing steps.

MIDI Mode

The Move option is still accessible when in MIDI / Synth mode. This parameter knob is similar in all modes but there may be some contextual difference.

Secondary Parameter

Micromove

Description

Moves select steps left or right on the sequencer grid in smaller iterations.

Range / Options

Moves steps early / left or later / right in small iterations up to, but excluding a half step length either direction. Range -11 to + 11.

Other Information

First number indicated micromove and second number full step length. Used for audio and MIDI steps.

MIDI Mode

The Micromove option is still accessible when in MIDI / Synth mode. This parameter knob is similar in all modes but there may be some contextual difference.

5

Samples & Synths

The heart of Play+ audio sound engine and the core of the instrument are samples and the synthesizer models. Play+ operates with 8 voices to cover the 8 audio tracks however samples or synths can be placed on any step in a pattern so there is no restriction to one sound per track. Play+ cannot record audio samples but does provide sample editing functions. The sample engine operates internally with 16 Bit Stereo PCM WAV files. WAV files can be imported with sample rates of 16/24/32 Bit Mono/Stereo and will be automatically converted. The main principle of Play+ is to quickly get started in creating and completing musical compositions and performing live sets. Samples are stored on the microSD card and therefore this must be inserted when working with projects. Each project has a sample pool which must be populated for access to the audio samples from a project. To maintain the focus on fast

music production, Play+ also operates with a unique approach to sample management. While it is possible to use discrete user samples, a Play+ specific sample pack will allow it to analysis and recognise samples intelligently. The placement and assembly of samples into a sample pack format is required. Play+ provides a set of tools for sample management and encourages a fast and simple workflow to pick and place a sample into a pattern sequence. Play+ comes with many sample packs provided to get the process running quickly. Play+ also has a 3 configurable synthesizers. A number of synth models are available which can be applied to each of the synths and then can be used for sequencing patterns. The synth models include 3 analog emulations and 1 FM model. More synth models will be available in future. Each synth has a set of adjustable parameters assigned as macros to the defined knobs. Presets are also available per synth.

5 Samples & Synths

5.1 Sample Pool.

NOTES

Each project uses samples located within the projects sample pool. In order to build a pattern a projects sample pool must be loaded with a sample pack or user samples, or both. Samples can be mono or stereo and can be loaded during playback. The normal workflow requires samples to be copied from the microSD card to the sample pool of the project. Sample Packs are formatted specifically to operate and integrate into Play+ functions. The Fill command, for example uses sample packs intelligently.

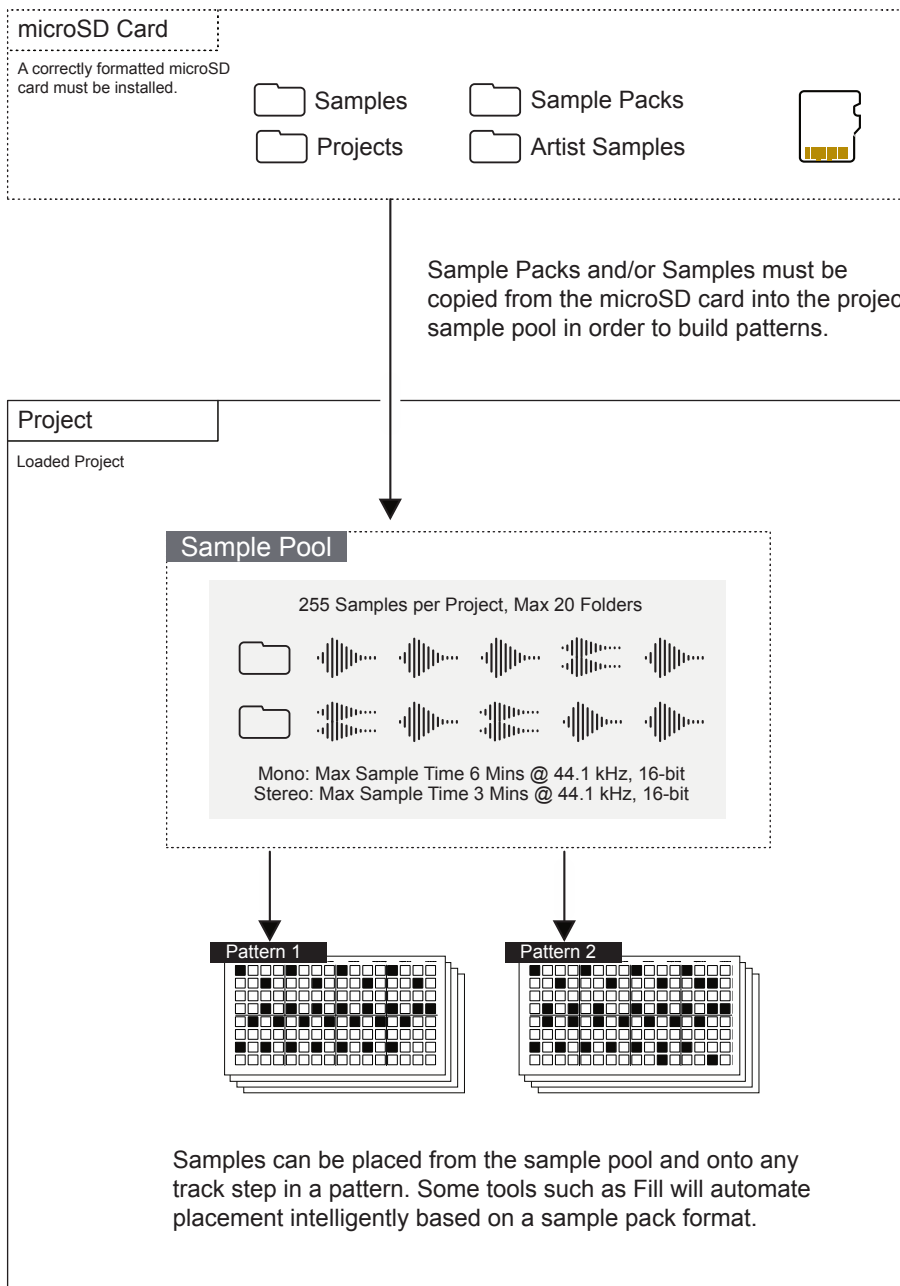

POPULATING THE SAMPLE POOL WITH SAMPLE PACKS

1. Ensure the project in which to work is open and active.
2. Press (Screen) knob to open the options menu.
3. Turn (Screen) to navigate the menu options. The menu may display the position level previously navigated. If required, Press [*Back*] screen button to back up through the menu hierarchy.
4. Highlight the 'Samples' option and press (Screen) to select.
5. Highlight the 'Load Sample Pack' option and press (Screen) to select.
6. The list of sample pack options will be displayed. Sample packs are recognised by the loader and are displayed and loaded as a complete folder. The sample pool memory status is also displayed. Turn (Screen) to navigate.
7. With the desired sample pack folder highlighted, indicated with a preceding '/', Press [*Load Pack*] screen button.
 - Sample packs with their respective folder structure and samples are loaded into the sample pool. Maximum 20 folders per pack and sample packs must have only one sub level folder.
 - If a folder already exists then a message will be displayed stating as such and the command will be cancelled. This will often be the case when trying to load multiple sample packs.
 - The available sample pool memory is displayed in the browser screen. If the sample pool memory limit is reached, the command will cancel. Packs, in part, may have been loaded until the memory limit was reached. A maximum of 255 samples can be located in the sample pool.
 - Press (Screen) when highlighting an audio sample file to audition the sample sound.

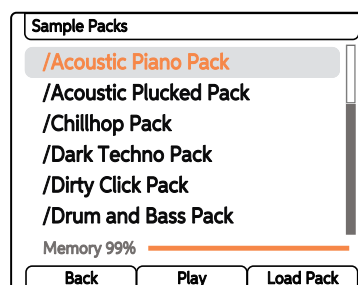

5 Samples & Synths

POPULATING THE SAMPLE POOL WITH USER SAMPLES

1. Ensure the project in which to work is open and active and that any user samples are loaded onto the installed microSD card. The 'Samples' folder is the default location for user sample folders.
2. Press (Screen) knob to open the options menu.
3. Turn (Screen) to navigate the menu options. The menu may display the position level previously navigated. If required, Press [Back] screen button to back up through the menu hierarchy.
4. Highlight the 'Samples' option and press (Screen) to select.
5. Highlight the 'Load Files or Folders' option and press (Screen) to select.
6. The default starting point is the 'SD/Samples' folder on the microSD card. This may be empty unless manually pre-populated. Turn (Screen) to navigate and Press [Back] if required.
7. A set of artist samples are also provided on the Polyend supplied microSD card. This can be accessed by backing up a level from the microSD card 'Samples' folder, press (Screen) when highlighting './.'. The Artist Samples can then be navigated and selected.
8. Turn (Screen) to highlight the folder or sample file to load into the sample pool. Hold [Shift] + Turn (Screen) to select multiple folders or files. Press (Screen) or either left side screen button when highlighting an audio WAV sample file to audition the sample sound.
9. Press [Load Wav] or [Load Folder] to select and load an audio file or a complete folder of samples.
10. When loading only a WAV audio sample, the sample pool destination folder is required to be selected.
11. The folder and samples are loaded to the sample pool.
 - If a folder already exists then a message will be displayed.
 - The available sample pool memory is displayed in the browser screen. If the sample pool memory limit is reached, the command will cancel. Files and folders, in part, may still have been loaded.
 - The structure of user samples may not follow the same format as sample packs. These will work ok in Play+ but may not benefit from the automated features applied to Play+ formatted sample packs.

VIEWING THE SAMPLE POOL

1. Ensure the project in which to work is open and active.
2. Press (Screen) knob to open the options menu.
3. Turn (Screen) to navigate the menu options. The menu may display the position level previously navigated. If required, Press [Back] screen button to back up through the menu hierarchy.
4. Highlight the 'Samples' option and press (Screen) to select.
5. Highlight the 'View Sample Pool' option and press (Screen) to select.
6. The list of sample pack folders will be displayed, named in the Play+ convention style. Press (Screen) and [Back] to navigate within the folder structures.
7. A WAV file can be auditioned in the browser. Press (Screen) or either left side screen button to play the sample's audio when highlighting an audio sample file.
8. The memory usage is shown as well as the number of files loaded into the sample pool.
9. The option to manually create a new folder in the sample pool or rename a folder is also possible.

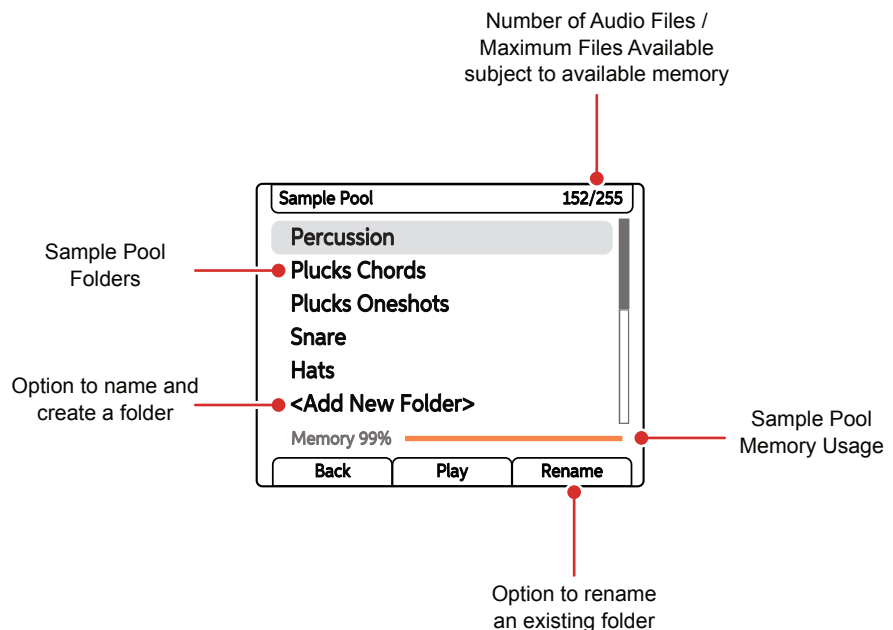

5 Samples & Synths

Samples are pre-loaded from the microSD card to the on board sample pool memory after creating a new project. Often, once the project has developed and patterns produced, some samples remain unused. These take up valuable memory and sample count, where the maximum is 255 samples per project. A quick and easy option exists in the Samples menu to remove unused samples from the sample pool. The sample is retained intact on the microSD card but is simply deleted from the sample pool.

DELETING A PROJECTS UNUSED SAMPLES

1. Ensure the project in which to work is open and active.
2. Press (Screen) knob to open the options menu.
3. Turn (Screen) to navigate the menu options. The menu may display the position level previously navigated. If required, Press [Back] screen button to back up through the menu hierarchy.
4. Highlight the 'Samples' option and press (Screen) to select.
5. Highlight the 'Delete Unused Samples' option and press (Screen) to select.
6. The process will remove any samples from the sample pool that are not used within the project patterns. These are only deleted from the sample pool and remain intact on the SD Card. Sample pool file count and memory usage will reflect this. Folder structures in the sample pool remain unchanged but will not be visible if empty when using the (Sample) knob for selecting samples.

Sample Count reset once samples are removed

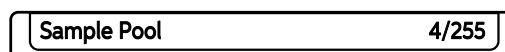

Original Sample Pool folders and structure for a project

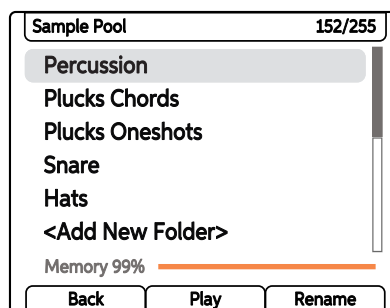

Memory reset once samples are removed

DELETING SAMPLES OR A FOLDER FROM THE SAMPLE POOL

1. Ensure the project in which to work is open and active.
2. Press (Screen) knob to open the options menu.
3. Turn (Screen) to navigate the menu options. The menu may display the position level previously navigated. If required, Press [Back] screen button to back up through the menu hierarchy.
4. Highlight the 'Samples' option and press (Screen) to select.
5. Highlight the 'View Sample Pool' option and press (Screen) to select. This deletion process cannot be applied to microSD card files or folders.
6. The list of sample pack folders will be displayed, named in the Play+ convention style. Press (Screen) and [Back] to navigate within the folder structures.
7. To delete a sample file.
 - Highlight the file to delete. Hold [Shift] + Turn (Screen) to select multiple files. Selected sample files are indicated in orange text.
 - Hold [Shift] + Press [Delete]. The files will be immediately deleted from the sample pool. They remain intact on the microSD card.
 - Any folders that exist in the sample pool but are empty will not be visible when using the (Sample) knob for sample selection.
8. To delete a folder.
 - Highlight the folder to delete. Only individual folders in the sample pool can be selected for deletion.
 - Hold [Shift] + Press [Delete]. The folder will be immediately deleted from the sample pool. They remain intact on the microSD card.

Note that the Undo / redo options is not available when in the sample pool file menu. Deleted samples would have to be reloaded from the microSD card to restore them to the sample pool.

5 Samples & Synths

■ CREATING OR RENAMING SAMPLE POOL FOLDERS

1. Ensure the project in which to work is open and active.
2. Press (Screen) knob to open the options menu.
3. Turn (Screen) to navigate the menu options. The menu may display the position level previously navigated. If required, Press [*Back*] screen button to back up through the menu hierarchy.
4. Highlight the 'Samples' option and press (Screen) to select.
5. Highlight the 'View Sample Pool' option and press (Screen) to select.
6. The list of sample pack folders will be displayed, named in the Play+ convention style. Press (Screen) and [*Back*] to navigate within the folder structures.
7. To edit:-
 - To add a new folder, scroll through to the bottom of the folder structure by turning (Screen). Highlight '<Add New Folder>' and Press (Screen).
 - To rename an existing folder, scroll through to highlight the folder to edit by turning (Screen). Highlight the target folder and Press [*Rename*] Screen Button.
8. The text editor pop-up will appear to name or rename the folder.
9. Once a name has been set for the folder, press left [*Confirm*] screen button to accept the name and create or rename the folder. The maximum number of folders is 20 per sample pack. Empty sample pool folders will not be visible when using the (Sample) knob for sample selection.

■ AUDITIONING SAMPLES WITHIN THE BROWSER MENU'S

1. To audition a sample when highlighted, Press (Screen) or Press one of the left side [*Screen*] buttons. The samples sound will be played out.
2. When browsing, Hold (Screen) or one of the [*Screen*] Left buttons while turning (Screen) and scrolling samples. This is usually performed easier and quicker by Holding [*Screen*] Left Button + Turn (Screen).

5.2 Sample Format.

Play+ will accept WAV samples in a variety of formats. The internal audio engine will operate with uncompressed 16bit stereo PCM Files at various sample rates. The conversion will be performed automatically to match the internal audio engine. The sample pool capacity will depend on the type files stored but is typically 6 Mins with 16-Bit, 44.1kHz Mono WAV's and 3 mins for Stereo. Lower sample rates will occupy less memory but will also have lower sound quality. A project holds a maximum of 255 samples.

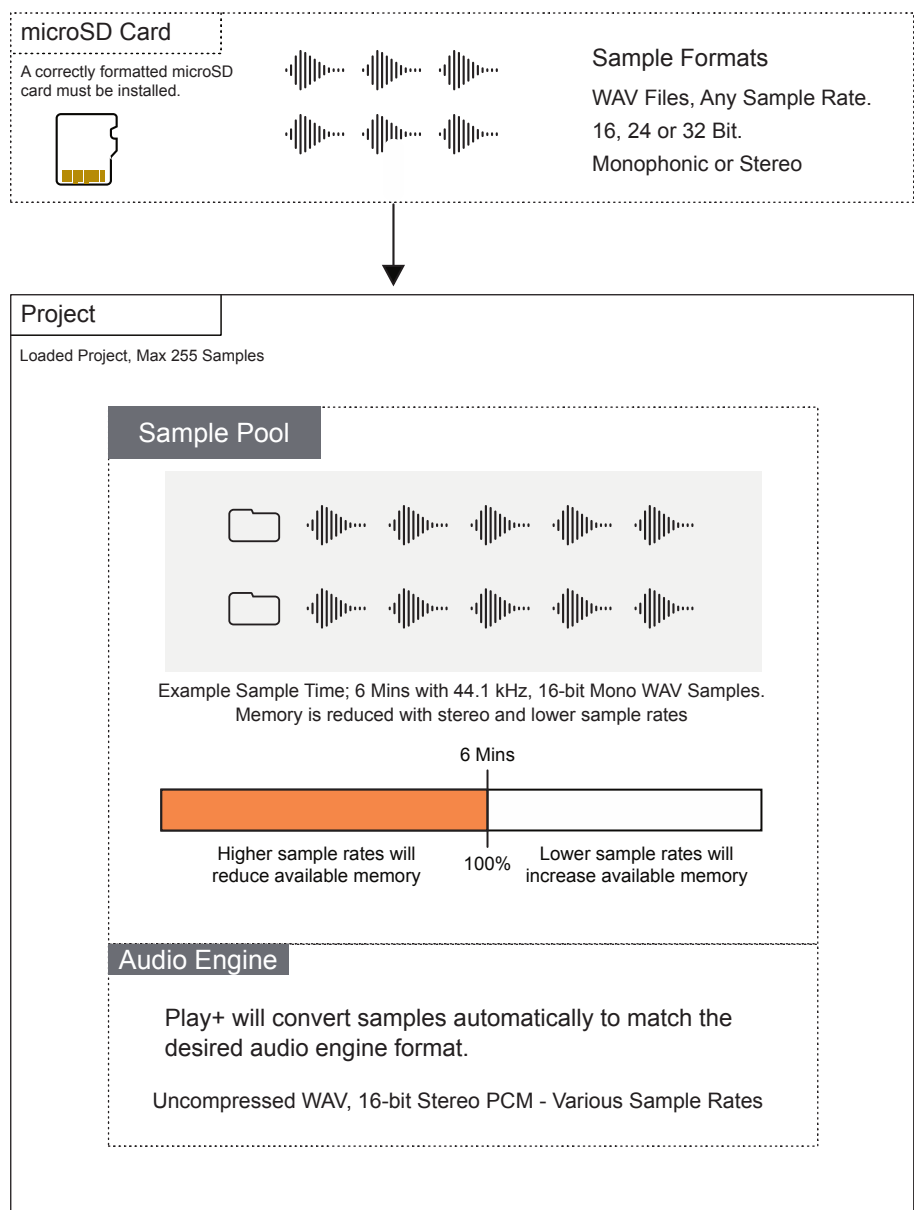

5 Samples & Synths

5.3 Sample Pack.

NOTES

Play+ sample packs are formatted specifically to operate within Play+ workflow, taking full advantage of the intelligent integration to its full feature set. User samples of course can also be used and have a more arbitrary format. In order for Play+ to recognise and integrate a sample pack fully it must fulfil a precise set of criteria. This will be taken into account with the official factory packs and extensions, but should also be considered when creating compatible custom sample packs.

Play+ Compatible Sample Pack Checklist

Required?	Condition	Description
✓	Maximum	255 Samples per pack
✓	Recommended	10-20 Samples per folder
✓	Maximum	20 Folders per pack.
✓	Maximum	1 Sub Folder level per pack. Structure must have a main folder with 1 level of sub folders i.e. for instruments No additional subfolders within the subfolders (2).
✓	Recommended	WAV Format, 16-Bit, 44.1kHz, Stereo or Mono. Other WAV formats 24, 32 bit, various sample rates as Play+ will automatically convert to the audio engine format.
✓	Absolute	0 dB Sample volume level.
✓	Absolute	C Note pitch tuning of melodic samples. Note parameter assumes original pitch of samples is C4.
✓	Absolute	Percussion folder names must include the exact word; Kick, Snare or HiHat. The text must be within the character string of the folder name for Beat Fill algorithm use (1).
✓	Absolute	Pack including samples / folders must be located on the microSD in the defined 'Sample Packs' Folder.

(1) if multiple folders exist with the beat fill character string, the algorithm will use the top folder, highest in the folder structure

(2) if multiple layers of subfolders exist, then only the first subfolder level will be loaded to the sample pool by the loader tool.

5.4 Deconstructing a Sample Pack.

Sample packs are built with a specific format and structure to maximise the benefits of Play+'s features. As an example of the components and structure the Dirty Click Pack from the factory library is illustrated.

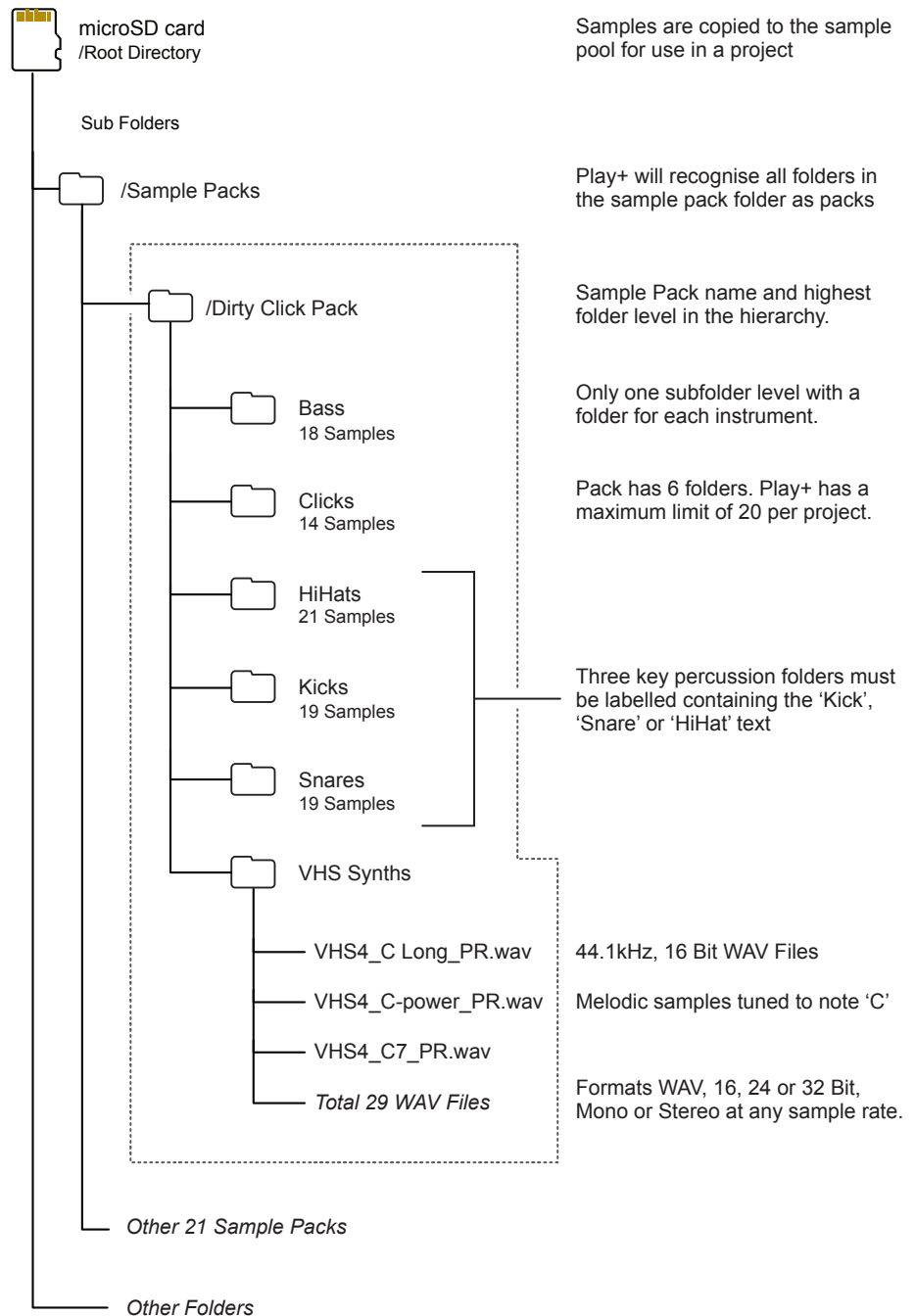

5 Samples & Synths

5.5 Sample Selection Overview.

NOTES

Play+ workflow for using samples starts with a 'pick and place' process. The first step is therefore to pick a sample to be placed onto the grid in order to create patterns. The sample has a number of parameters that can be edited. The sample selected and any other parameter settings are held in the buffer memory which then allows continuous and repeated placement in the sequencer. When sequencer steps and tracks are deselected, the sample and other parameter settings edited together collectively, ready for step placement are called the 'work step'.

SELECTING A SAMPLE TO EDIT OR PLACE IN THE SEQUENCER

1. Ensure the project in which to work is open and active and the sample pool is populated with samples.
2. Ensure no steps or tracks are selected.
3. Double tap (Folder) to select the Folder parameter in the sample / folder screen. This allows selection of the sample folder from which to select a sample. Turn (Folder) to select the sample pool folder. Only folders which contain samples will be visible.
4. Tap (Sample) to select the sample parameter. Also Press left upper or lower [Screen] buttons to switch selection between the sample and folder parameter option.
5. Turn (Sample) to navigate the sample selection. Also Turning (Screen) will adjust the in focus parameter currently selected on the screen. Samples are auditioned while browsing when the sequencer is stopped.
6. Once a sample is selected, a number of sample related parameters can be edited. The sample is auditioned as edits are made as long as the sequencer is stopped and not playing.
7. The sample can be placed into a pattern by tapping a grid pad.

5.6 Sample Related Parameters.

A number of the primary and secondary parameters available in Play+ are directly related to the selected sample. These can be adjusted as part of the 'work step' and then applied to steps when creating patterns.

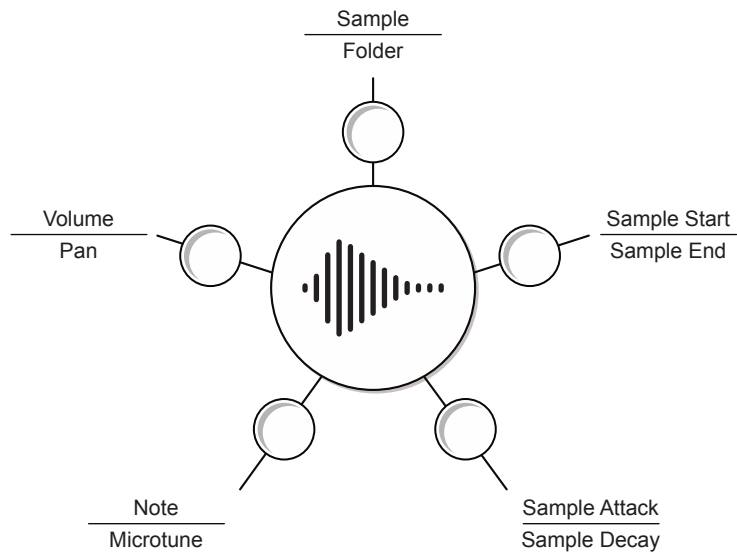

Sample Based Parameters

Parameter	Primary / Secondary	Description
Sample	Primary	Active sample selected from the folder.
Folder	Secondary	Sample pool folder to select sample from.
Sample Start	Primary	Sample start position in milliseconds. Shows position with respect to the total duration in ms.
Sample End	Secondary	Sample start position in milliseconds. Shows position with respect to the total duration in ms.
Sample Attack	Primary	Attack - Fade In phase at the sample start in %.
Sample Decay	Secondary	Decay - Fade Out phase at the sample end in %.
Note	Primary	Adjust note in semitones with respect to the original sample pitch. It is assumed original root note is 'C4'.
Microtune	Secondary	Tunes note in cents over a range of +/-100 cents.
Volume	Primary	Adjusts the sample volume level with respect to its current level. 0dB refers to original level.
Pan	Secondary	Adjusts the stereo left to right panorama over a range of 100L - Center - 100R.

Sample edits will audition sound when adjusting parameters - sequencer must be stopped.

5 Samples & Synths

5.7 Synthesizer Options

NOTES

Play+ has 3 synthesizer slots each of which can be assigned 1 of 6 synthesizer models. Each synthesizer has six editable macros directly available within the knob section and which contribute to the overall synth patch. These macro parameters will vary depending on the synth engine selected. Synth patches are also available for direct selection. Play+ operates with up to 8 Voices, assigned per patch.

ACD



ACD transports you back to the golden age of electronic music with its recreation of iconic single-oscillator monophonic analog synths. Paying homage to Japanese legends, ACD not only captures the essence of these classics but also propels you into the future with a lightning-fast synthesis experience. It offers a rich palette of options, ranging from faithful monophonic analog recreations to entirely unique and innovative soundscapes.

FAT



FAT is a powerhouse synth engine that epitomizes the lush, vintage warmth of classic analog synthesizers. At its core, FAT hosts three virtual analog oscillators and offers an intuitive drift and detune control, ensuring you can effortlessly sculpt iconic massive sounds. The presets contain two distinct flavors of ladder filters inspired by two unique analog classics. It offers a versatile range of sounds, from deep reese basses to ethereal pads, expressive leads and classic keyboards.

VAP



VAP is a virtual analog polysynth, boasting a dual-oscillator architecture and a versatile modulation matrix. Complete with multiple filter flavors and pulse width modulation, VAP allows you to sculpt intricate patterns. This engine shines when it comes to creating mesmerizing, evolving textures, crafting lush pads, and conjuring up one-of-a-kind sound effects.

WTFM



WTFM is a unique 2-operator FM synth engine that utilized wavetable based oscillators driven by a 3x feedback system. The operators are based on sweeping wavetables, ranging from fundamental sine waves to harmonically rich timbres, offering a diverse tonal palette. Whether you're sculpting smooth, enveloping pads or crafting cutting-edge metallic tones, WTFM empowers you to achieve unique textures with precision and authenticity.

PERC



PERC is a unique drum machine that is loaded into one synth engine instrument. It uses 1 voice but can play back up to five unique drum sounds at once. Drums include a Kick, Tom, Snare, open and closed Hi-Hats, Cymbal, and Perc. The perc drum has multiple options including snare, clap, cowbell and more. Each drum is individually tweakable with multiple parameters for each hit, for a massive variety of drum tones.

DIRT



Dirt is a synth designed for waveshaping, warping, and creating massive basslines, glitchy textures, or gritty lo-fi pads. Warp a core oscillator, mix in a sub with a dedicated low pass filter, and choose from 13 waveshaper modes that combine shaper modulation control, flexible filter routing, and gain staging. Dirt provides a massive palette of overdriven timbres.

More new synth models will be added to the Play+ option list in future OS updates.

CONFIGURING A SYNTHESIZER AND MODEL

1. Ensure the project in which to work is open and active.
2. Press (Screen) to select the options menu.
3. Turn (Screen) to highlight and Press to select 'Synths' options.
4. Each of the available 3 synths can have one of the 5 synth models assigned. This will determine its audio style and format. Turn (Screen) to highlight and press select one of the Synths.
5. Thee available parameters will be presented. Use the (Screen) control to select and change the options:-
 - Model: This selects from the available models to assign to the synth.
 - Patch: This selects a patch for the defined model. Patches configured parameter settings used to store a specific sound. These are stored on the microSD card and will determine the sound style and also the available parameter macros to the user.
 - Polyphony: The number of voices assigned to the synth. Up to 8 voices of polyphony are available in total in Play+ across all synths. The 8 voices are divided and allocated per synth, for example Synth 1 = 3, Synth 2 = 3, Synth 3 = 2.
 - Gain: Adjusts the audio gain for the synth.
 - Panning. Adjusts the stereo spread for the synth.

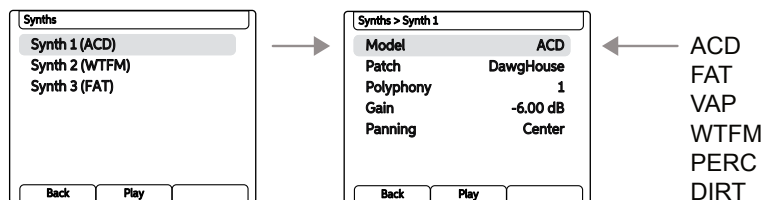

5 Samples & Synths

SELECTING A SYNTH



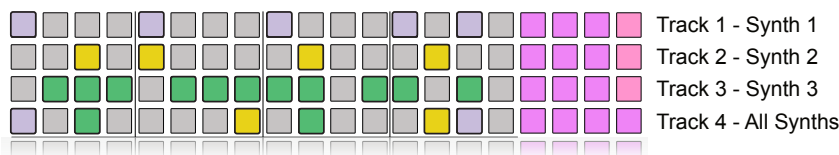

1. Ensure the project in which to work is open and active.
2. Switch Play+ to change Audio/MIDI Mode. Press [Shift] + [Audio/MIDI]. The Function buttons will be lit purple for MIDI and Synth tracks as opposed to green when purely in audio sample track mode.
3. Turn the (Sample) knob which is now assigned to the device list. The three synth slots can be found in the device list along with the MIDI device options.
4. Double tap (Sample) or press the lower left screen button to choose the secondary patch parameter. Turn (Patch) to select a synth preset patch.
5. Press a [Pad] to place on a step. The synth selected will determine the pad color: Synth 1, Violet; Synth 2, Yellow; Synth 3, Green.
6. The synth model can be changed for each of the four synthesizers within the settings options by pressing (*Screen*) and selecting 'Synths'. Each of the 3 synths can then be assigned a discrete synth model.

Example: Synth Patterns

MIDI / Synth mode is indicated by purple function buttons.



3 Synths are available, each can be assigned a synth model. The steps are designated by the color of the pad.

-  Off. Step is empty and does not trigger any event. Tap [Pad].
-  Violet. Step has an active Synth 1 note event. Tap [Pad].
-  Yellow. Step has an active Synth 2 note event. Tap [Pad].
-  Green. Step has an active Synth 3 note event. Tap [Pad].

ADJUSTING A SYNTH MACRO PARAMETERS

1. Ensure the project in which to work is open and active.
2. Switch Play+ to change Audio/MIDI Mode. Press [Shift] + [Audio/MIDI]. The Function buttons will be lit purple for MIDI and Synth tracks as opposed to green when purely in audio sample track mode.
3. Press a [Pad] to place on a step or hold the [Pad] to edit. Editing a general set of parameters will affect the work step settings.
4. The synth selected will determine the pad color: Synth 1, Violet; Synth 2, Yellow; Synth 3, Green.
5. The synth parameters available are assigned to 6 macro controls allocated to the Play+ knobs and assigned automatically based on the synth patch selected.
6. To change a parameter adjust the respective (Knob). The 6 knob functions are determined within the patch.
7. To change the patch Tap (Sample). The patch options are available when Synth 1, 2 or 3 is selected. Patches are defined per synth. The lower parameter will adjust the patch. Tap the lower left [Screen] button or double tap (Sample) to select the parameter and turn to edit.

Synth Track Parameters

When MIDI / Synth Mode is selected, Synth specific parameters are available within the knob section. However, these are labelled as per the original audio sample nomenclature and will revert to the synth parameters and macros per synth engine when a Synth is selected.

Synths selected using the (Device) Knob

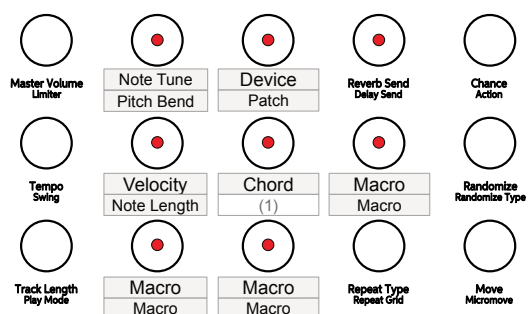
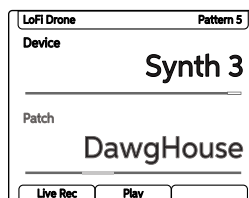

The use of macros allows various parameters to be assigned to the 6 knobs and offers more flexibility with patches that when using fixed parameter assignments.

The chance and randomize functions also can be applied in MIDI / Synth mode to the Macro assigned to the 'Filter Cutoff' option. Filter CC/Macro is available as a Randomize type option and Rnd Cutoff CC as a Chance action.

(1) reserved for future Use.

5 Samples & Synths

5.8 Synthesizer Patch Editor Basics.

NOTES

Play+ has 3 synthesizers which operate with patches to define the precise sound. Each patch will be representative of the synth model assigned. Parameters can be controlled directly from the macro knobs. A patch can be created and edited within Play+ patch editor. The macro assignments and parameter settings of the knobs can also be configured for each patch.

3 Synths are available, each can be assigned one of the 4 synth models

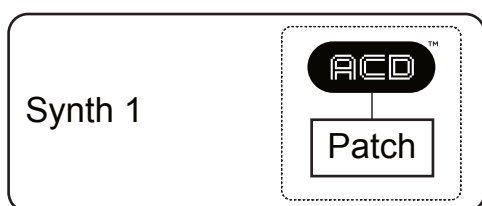

The patch editor is found in the synth settings

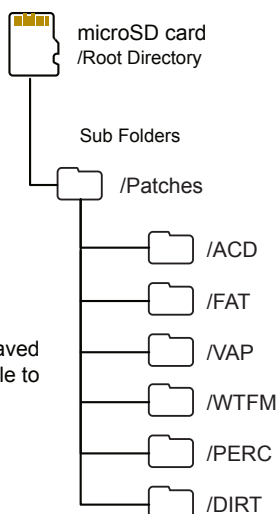
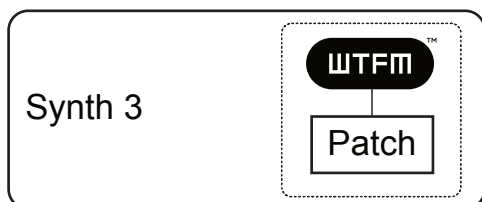

Patches for each synth model are saved to the microSD card and are available to be loaded per synth.

OVERVIEW OF SYNTHESIZER BASIC PATCH CONTROLS

1. Ensure the project in which to work is open and active.
2. Press (Screen) to select the options menu.
3. Turn (Screen) to highlight and Press to select 'Synths' options.
4. Each of the available 3 synths can have one of the available synth models assigned. This will determine its audio style and format. Turn (Screen) to highlight and press to select one of the Synths.
5. The available parameters will be presented including the patch. Turn the (Screen) control to highlight the 'Patch'.
6. Press (Screen) with 'Patch' highlighted to access the patch list. Only the patches available for the assigned model are available.
7. To Select a Patch. Turn (Screen) to scroll through the patches and Press (Screen) to select and load a patch to the synth.
8. To Preview a Patch. Turn (Screen) to scroll through the patches
 - Press the Upper Left [Screen] button to preview the highlighted patch. The upper button previews with note C4.
 - Press the Lower Left [Screen] button to preview the highlighted patch. The lower button previews with note C2.
9. For patch management, backup to the main synth menu. Press [Back] if needed.
 - To initialise the patch. Turn (Screen) to highlight 'Init Patch'. Press (Screen) to select and initialise the patch to a default state.
 - To save the patch. Turn (Screen) to highlight 'Save Patch' or 'Save Patch as' to save with a new name. Press (Screen) to save.
 - To edit the currently selected patch. Turn (Screen) to highlight 'Edit Patch'. Press (Screen) to open the patch editor and access the settings for the patch parameters.

5 Samples & Synths

5.9 Editing a Synthesizer Patch.

NOTES

A patch can be initialised as a blank starting point and edited to create new sounds. These can then be saved to the microSD card. Each synth model has a number of parameters specific to the engine loaded. The patch editor is where patch settings can be adjusted.

EDITING A PATCH

1. Ensure the project in which to work is open and active.
2. Press (Screen) to select the options menu.
3. Turn (Screen) to highlight and press to select the 'Synths' option.
4. One of the available 3 synth slots can be selected and a synth model can be assigned. Choose the 'Model' option, then turn (Screen) to choose the synth and press to select. This will determine its audio style and format.
5. Either initialise the patch or load the patch to edit.
6. To edit the currently selected patch. Turn (Screen) to highlight 'Edit Patch'. Press (Screen) to open the patch editor and access the settings for the patch parameters.
7. Up to 9 of the synth parameters are presented. Each parameter is represented by one of the central 9 rotary knobs. So the first parameter, displayed upper left is edited using the (Note) knob and so forth.
8. Turn or press (Screen) to change the synth function parameter page.
9. The screen (Back) button will navigate to the synth main menu.
10. It is good practice to save the patch during editing and also when editing is complete. This option is in the main synth menu.

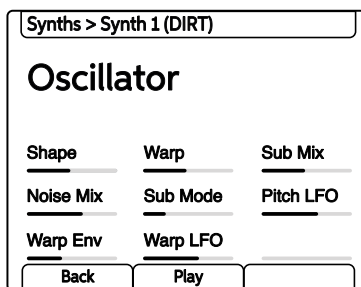

The 9 displayed patch editor parameters are controlled using the 9 central rotary knobs.

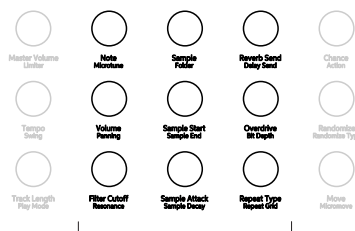

Each synth model has a designated set of parameters whose values define the patch sound.



Function	Parameter	Range	Description
Oscillator	Saw Mix	0-100%	Saw wave mix
Oscillator	Square Mix	0-100%	Square wave mix
Oscillator	Sub Mix	0-100%	Sub oscillator mix
Oscillator	Noise Mix	-100% to 100%	Noise generator mix
Oscillator	PW	0-100%	Pulse Width
Oscillator	Sub Mode	Options	Sub oscillator options for square, pulse and triangle waves -1 or -2 octaves below the main oscillator
Oscillator	Pitch LFO	-100% to 100%	Amount of the LFO modulation applied to the oscillator pitch.
Oscillator	PW Env	-100% to 100%	Pulse width envelope.
Oscillator	PW LFO	-100% to 100%	Amount of the LFO modulation applied to the oscillator pulse width i.e pulse width modulation.
Filter	Cutoff	20Hz - 20kHz	Filter cutoff frequency.
Filter	Resonance	0-100%	Filter resonance amount.
Filter	Type	Options	Filter types: Low Pass State Variable 12dB; Low Pass State Variable 24dB; Low Pass RD3.
Filter	Env amt	-100% to 100%	Filter envelope amount
Filter	Note track	-200% to 200%	Amount of modulation applied based on the pitch of the note played.
Filter	LFO amt	-100% to 100%	Low Frequency Oscillator modulation amount applied to the filter
Amplifier	Attack	0.00-10 Sec	Amplifier envelope attack time
Amplifier	Decay	0.00-10 Sec	Amplifier envelope decay time
Amplifier	Sustain	0.00-100%	Amplifier envelope sustain level
Amplifier	Release	0.00-10 Sec	Amplifier envelope release time

5 Samples & Synths

NOTES



Continued

Function	Parameter	Range	Description
Modulation	Attack	0.00-10 Sec	Modulation envelope attack time
Modulation	Decay	0.00-10 Sec	Modulation envelope decay time
Modulation	Sustain	0.00-100%	Modulation envelope sustain level
Modulation	Release	0.00-10 Sec	Modulation envelope release time
Modulation	Frequency	0.1 to 100Hz	Speed of the modulation wave
Modulation	Waveform	Options	Modulation wave shape: Triangle; Sin; Ramp Up; Ramp Down; Square; Random S&H
Modulation	Retrigger	Options	Waveform retrigger: Free running will continuously run; One Shot will cycle once when a note is triggered; Note will trigger from the start and continuously run each time a note is triggered.
Voice	Glide Mode	Options	Slide between notes: Always, Overlap, Legato i.e. Envelopes are not triggered, Legato Overlap
Voice	Glide Time	0.00 - 3 Sec	Time of slide between notes.
Voice	Volume	0-200%	Volume level of oscillator voice
Macros	Attack		Default Macro for the sample attack knob
Macros	Decay/Release		Default Macro for the sample decay knob
Macros	Osc Mix		Default Macro for the bit depth knob
Macros	Filter cutoff		Default Macro for the filter cutoff knob
Macros	Filter resonance		Default Macro for the filter resonance knob
Macros	Filter env amount		Default Macro for the overdrive knob
Macros	Velocity		Default Macro for the volume knob

NOTES



Function	Parameter	Range	Description
Oscillator	Fatness	0-100	Oscillator style
Oscillator	Brightness	0-100	Oscillator style
Oscillator	Timbre	0-100	Oscillator style
Oscillator	LFO Amt	0-100%	Amount of LFO applied
Oscillator	Noise	0-100%	Amount of Noise applied
Oscillator	Reset	Options	On or Off. On, resets oscillator cycle on each note trigger.
Filter	Cutoff	20Hz - 20kHz	Filter cutoff frequency
Filter	Resonance	0-100%	Filter resonance amount.
Filter	Type	Options	Low Pass MG 24dB, Low Pass OB 24dB, Low Pass OB 12dB classic filter emulations.
Filter	Env Amt	-100% to 100%	Filter envelope amount
Filter	LFO Amt	-100% to 100%	Low Frequency Oscillator modulation amount applied to the filter
Amplifier Env	Attack	0.00-10 Sec	Amplifier envelope attack time
Amplifier Env	Decay	0.00-10 Sec	Amplifier envelope decay time
Amplifier Env	Sustain	0.00-100%	Amplifier envelope sustain level
Amplifier Env	Release	0.00-10 Sec	Amplifier envelope release time
Filter Env	Attack	0.00-10 Sec	Filter envelope attack time
Filter Env	Decay	0.00-10 Sec	Filter envelope decay time
Filter Env	Sustain	0.00-100%	Filter envelope sustain level
Filter Env	Release	0.00-10 Sec	Filter envelope release time
LFO	Frequency	0.1 to 100Hz	Speed of the modulation wave
LFO	Waveform	Options	Modulation waveshape: Triangle; Sin; Ramp Up; Ramp Down; Square; Random S&H
LFO	Retrigger	Options	Waveform retrigger: Free running will continuously run; One Shot will cycle once when a note is triggered; Note will trigger from the start and continuously run each time a note is triggered.

5 Samples & Synths

NOTES



Continued

Function	Parameter	Range	Description
Voice	Glide Mode	Options	Slide between notes: Always, Overlap, Legato i.e. Envelopes are not triggered, Legato Overlap
Voice	Glide Time	0.00 - 3 Sec	Time of slide between notes.
Voice	Volume	0-200%	Volume level of oscillator voice.
Macros	Attack		Default Macro for the sample attack knob
Macros	Decay/Release		Default Macro for the sample decay knob
Macros	Motion		Default Macro for the bit depth knob
Macros	Filter Cutoff		Default Macro for the filter cutoff knob
Macros	Filter Resonance		Default Macro for the filter resonance knob
Macros	Filter Env amount		Default Macro for the overdrive knob
Macros	Velocity		Default Macro for the volume knob



Function	Parameter	Range	Description
Oscillators	Mix	-100% to 100%	Oscillator mix
Oscillators	Shape 1	0-100	Oscillator 1 shape. Setting morphs between triangle, saw and square.
Oscillators	Shape 2	0-100	Oscillator 2 shape. Setting morphs between triangle, saw and square.
Oscillators	PW 1	-50 to 50	Oscillator 1 Pulse Width
Oscillators	PW 2	-50 to 50	Oscillator 2 Pulse Width
Oscillators	Tune 1	-36 to 36 st	Oscillator 1 Tuning in semitones
Oscillators	Tune 2	-36 to 36 st	Oscillator 2 Tuning in semitones
Oscillators	Finetune	-100 to 100	Finetuning in cents
Oscillators	Detune	0-100 c	Detuning in cents
Oscillators	Noise	0-100%	Noise amount
Oscillators	Sync	Options	When set to On, Oscillator 2 resets on each cycle of Oscillator 1 (Osc 1 controls pitch).
Oscillators	Reset 1	Options	Oscillator 1 wave reset on note on, on or off
Oscillators	Reset 2	Options	Oscillator 2 wave reset on note on, on or off
Filter	Cutoff	20Hz - 20kHz	Filter cutoff frequency.
Filter	Resonance	0-100%	Resonance amount.
Filter	Type	Options	Low Pass MG 24dB, Low Pass OB 24dB, Low Pass OB 12dB, Low Pass SVF 24dB, Low Pass SVF 12dB, Hi Pass OB 24dB, Hi Pass OB 12dB, Hi Pass SVF 24dB, Hi Pass SVF 12dB, Band Pass OB 24dB, Band Pass OB 12dB, Band Pass SVF 24dB, Band Pass SVF 12dB, Notch SVF 24dB, Notch SVF 12dB,
Filter	Env Amt	-100% to 100%	Filter envelope amount
Filter	Note track	-200% to 200%	Amount of modulation applied based on the pitch of the note played.

5 Samples & Synths



Continued

Function	Parameter	Range	Description
Amplifier Env	Attack	0.00-10 Sec	Amplifier envelope attack time
Amplifier Env	Decay	0.00-10 Sec	Amplifier envelope decay time
Amplifier Env	Sustain	0.00-100%	Amplifier envelope sustain level
Amplifier Env	Release	0.00-10 Sec	Amplifier envelope release time
Envelope 1	Attack	0.00-10 Sec	Amplifier envelope attack time
Envelope 1	Decay	0.00-10 Sec	Amplifier envelope decay time
Envelope 1	Sustain	0.00-100%	Amplifier envelope sustain level
Envelope 1	Release	0.00-10 Sec	Amplifier envelope release time
Envelope 2	Attack	0.00-10 Sec	Amplifier envelope attack time
Envelope 2	Decay	0.00-10 Sec	Amplifier envelope decay time
Envelope 2	Sustain	0.00-100%	Amplifier envelope sustain level
Envelope 2	Release	0.00-10 Sec	Amplifier envelope release time
LFO 1	Sync	Options	When set to On, Oscillator 2 resets on each cycle of Oscillator 1 (Osc 1 controls pitch).
LFO 1	Ratio	0-100 Hz	
LFO 1	Waveform	Options	Modulation wave shape: Triangle; Sin; Ramp Up; Ramp Down; Square; Random S&H
LFO 1	Retrigger	Options	Waveform retrigger: Free running will continuously run; One Shot will cycle once when a note is triggered; Note will trigger from the start and continuously run each time a note is triggered.
LFO 2	Sync	Options	When set to On, Oscillator 2 resets on each cycle of Oscillator 1 (Osc 1 controls pitch).
LFO 2	Ratio	0-100 Hz	
LFO 2	Waveform	Options	Modulation wave shape: Triangle; Sin; Ramp Up; Ramp Down; Square; Random S&H
LFO 2	Retrigger	Options	Waveform retrigger: Free running will continuously run; One Shot will cycle once when a note is triggered; Note will trigger from the start and continuously run each time a note is triggered.



Continued

Function	Parameter	Range	Description
Modulation	Src 1	Options	Modulation source options: Amp Env; Env1 (ftr); Env2; LFO1; LFO2
Modulation	Dest 1	Options	Modulation destination options: Osc1 PWM; Osc2 PWM; Osc Mix; Filter Cutoff; Amp Env Sustain; Filter Env Sustain; Wave Env SustainVolume; Osc1 Pitch; Osc2 Pitch; Filter Env Decay; Noise Volume; Osc1 Shape; Osc2 Shape
Modulation	Amt 1	-100% to 100%	Modulation amount
Modulation	Src 2	Options	Modulation source options: Amp Env; Env1 (ftr); Env2; LFO1; LFO2
Modulation	Dest 2	Options	Modulation destination options: Osc1 PWM; Osc2 PWM; Osc Mix; Filter Cutoff; Amp Env Sustain; Filter Env Sustain; Wave Env SustainVolume; Osc1 Pitch; Osc2 Pitch; Filter Env Decay; Noise Volume; Osc1 Shape; Osc2 Shape
Modulation	Amt 2	-100% to 100%	Modulation amount
Modulation	Src 3	Options	Modulation source options: Amp Env; Env1 (ftr); Env2; LFO1; LFO2
Modulation	Dest 3	Options	Modulation destination options: Osc1 PWM; Osc2 PWM; Osc Mix; Filter Cutoff; Amp Env Sustain; Filter Env Sustain; Wave Env SustainVolume; Osc1 Pitch; Osc2 Pitch; Filter Env Decay; Noise Volume; Osc1 Shape; Osc2 Shape
Modulation	Amt 3	-100% to 100%	Modulation amount
Modulation	Src 4	Options	Modulation source options: Amp Env; Env1 (ftr); Env2; LFO1; LFO2
Modulation	Dest 4	Options	Modulation destination options: Osc1 PWM; Osc2 PWM; Osc Mix; Filter Cutoff; Amp Env Sustain; Filter Env Sustain; Wave Env SustainVolume; Osc1 Pitch; Osc2 Pitch; Filter Env Decay; Noise Volume; Osc1 Shape; Osc2 Shape
Modulation	Amt 4	-100% to 100%	Modulation amount
Modulation	Src 5	Options	Modulation source options: Amp Env; Env1 (ftr); Env2; LFO1; LFO2
Modulation	Dest 5	Options	Modulation destination options: Osc1 PWM; Osc2 PWM; Osc Mix; Filter Cutoff; Amp Env Sustain; Filter Env Sustain; Wave Env SustainVolume; Osc1 Pitch; Osc2 Pitch; Filter Env Decay; Noise Volume; Osc1 Shape; Osc2 Shape
Modulation	Amt 5	-100% to 100%	Modulation amount

5 Samples & Synths



Continued

Function	Parameter	Range	Description
Modulation	Src 6	Options	Modulation source options: Amp Env; Env1 (ftr); Env2; LFO1; LFO2
Modulation	Dest 6	Options	Modulation destination options: Osc1 PWM; Osc2 PWM; Osc Mix; Filter Cutoff; Amp Env Sustain; Filter Env Sustain; Wave Env SustainVolume; Osc1 Pitch; Osc2 Pitch; Filter Env Decay; Noise Volume; Osc1 Shape; Osc2 Shape
Modulation	Amt 6	-100% to 100%	Modulation amount
Voice	Glide Mode	Options	Slide between notes: Always, Overlap, Legato i.e. Envelopes are not triggered, Legato Overlap
Voice	Glide Time	0.00 - 3 Sec	Time of slide between notes.
Voice	Volume	0-200%	Volume level of oscillator voice.
Macros	Attack		Default Macro for the sample attack knob
Macros	Decay/ Release		Default Macro for the sample decay knob
Macros			Default Macro for the bit depth knob
Macros	Filter Cutoff		Default Macro for the filter cutoff knob
Macros	Filter Resonance		Default Macro for the filter resonance knob
Macros	Filter Env Amount		Default Macro for the overdrive knob
Macros	Velocity		Default Macro for the volume knob



Function	Parameter	Range	Description
Oscillator	Shape	0% to 100%	Main oscillator shape.
Oscillator	Warp	-100% to 100%	Warp amount.
Oscillator	Sub Mix	0-100%	Amount of sub osc applied to the mix.
Oscillator	Noise Mix	-100% to 100%	Amount of noise introduced in dirt.
Oscillator	Sub Mode	Options	Sub oscillator shape from square, pulse and triangle set and set to -1 or -2 Octave lower.
Oscillator	Pitch LFO	-100% to 100%	Amount of LFO applied to the osc pitch.
Oscillator	Warp Env	-100% to 100%	Amount of envelope applied to warp.
Oscillator	Warp LFO	-100% to 100%	Amount of LFO applied to warp.
Shaper	Shaper	Options	None or...
			Saturation, subtle harmonic distortion. Overdrive, subtle harmonic distortion. Diode, symmetrical diode clipping. Fuzz, classic fuzz tone. Asymmetric, diode clipping. Sin, a sine wave to shape the signal. Sin+, warped waveform shapes the signal. Rectifier, Converts a bipolar signal to unipolar for clipped drive tones. Adds the possibility of octave up effects. Bitcrush, Reduces the number of bits in the audio signal. Bitcrush+. Redux, Sample Rate Reduction. Redux+ Bitcrush+Redux.
Shaper	Amount	0-100%	Amount of shaper applied.
Shaper	Mod Env	-100% to 100%	Amount of modulation envelope applied.
Shaper	Routing	Options	Pre or Post filter positioning of the shaper
Shaper	Pre Gain	0-100	Input gain adjustment.
Filter	Cutoff	20Hz - 20kHz	Filter cutoff frequency. Set the frequency or set filter to off.
Filter	Resonance	0-150%	Resonance amount.
Filter	Type	Options	Low Pass SVF 12dB, Low Pass SVF 24dB, Low Pass RD3.
Filter	Env Amt	-100% to 100%	Filter envelope amount
Filter	Note Track	-200% to 200%	Amount of modulation applied based on the pitch of the note played.
Filter	LFO Amt	-100% to 100%	Amount of LFO applied to the filter.

5 Samples & Synths

NOTES



Continued

Function	Parameter	Range	Description
Amplifier	Attack	0-10 Sec	Amp envelope attack time.
Amplifier	Decay	0-10 Sec	Amp envelope decay time.
Amplifier	Sustain	0-100%	Amp envelope sustain level.
Amplifier	Release	0-10 Sec	Mod envelope release time.
Modulation	Attack	0-10 Sec	Mod envelope attack time.
Modulation	Decay	0-10 Sec	Mod envelope decay time.
Modulation	Sustain	0-100%	Mod envelope sustain level.
Modulation	Release	0-10 Sec	Mod envelope release time.
Modulation	Frequency	0.1Hz to 100Hz	Modulation LFO speed.
Modulation	Waveform	Options	LFO Shape: Triangle, Sin, Ramp Up, Ramp Down, Square, Random Sample and Hold.
Modulation	Retrigger	Options	LFO retrigger options: Note, One Shot, Free Running
Voice	Glide Mode	Options	Slide between notes: Always, Overlap, Legato i.e. Envelopes are not triggered, Legato Overlap
Voice	Glide Time	0.00 - 3 Sec	Time of slide between notes.
Voice	Volume	0-200%	Volume level of oscillator voice.



Function	Parameter	Range	Description
Oscillator	FM	0% to 1000%	Frequency Modulation
Oscillator	Ratio 1	0.25 - 12	Oscillator 1 FM Ratio
Oscillator	Ratio 2	0.25 - 12	Oscillator 2 FM Ratio
Oscillator	Shape 1	0-100	Position in the wavetable of Osc 1 shapes
Oscillator	Shape 2	0-100	Position in the wavetable of Osc 2 shapes
Oscillator	Character 1	Options	Row of wavetable shapes: Smoother; Sharper; Wilder; Add 1; Add 2; Add 3; Add 5; Add 7; Add 11
Oscillator	Character 2	Options	Row of wavetable shapes: Smoother; Sharper; Wilder; Add 1; Add 2; Add 3; Add 5; Add 7; Add 11
Oscillator	Feedback 1	0-100%	Operator 1 Feedback
Oscillator	Feedback 2	0-100%	Operator 2 Feedback
Oscillator	Feedback2>1	0-100%	Operator 2 into 1 Feedback
Oscillator	Finetune 1	-100 to 100 c	Finetuning in cents of operator 1
Oscillator	Finetune 2	-100 to 100 c	Finetuning in cents of operator 2
Oscillator	Reset 1	Options	Oscillator 1 wave reset on note on, on or off
Oscillator	Reset 2	Options	Oscillator 2 wave reset on note on, on or off
Oscillator	Oversampling	Options	Pre-filter x2 oversampling on or off.
Filter	Cutoff	20Hz - 20kHz	Filter cutoff frequency
Filter	Resonance	0-100%	Resonance
Filter	Type	Options	Low Pass MG 24dB, Low Pass OB 24dB, Low Pass OB 12dB, Low Pass SVF 24dB, Low Pass SVF 12dB, Hi Pass OB 24dB, Hi Pass OB 12dB, Hi Pass SVF 24dB, Hi Pass SVF 12dB, Band Pass OB 24dB, Band Pass OB 12dB, Band Pass SVF 24dB, Band Pass SVF 12dB, Notch SVF 24dB, Notch SVF 12dB,
Filter	Env Amt	-100% to 100%	Filter envelope amount
Filter	Note Track	-200% to 200%	Amount of modulation applied based on the pitch of the note played.

5 Samples & Synths

NOTES



Continued

Function	Parameter	Range	Description
Amplifier Env	Attack	0.00-10 Sec	Amplifier envelope attack time
Amplifier Env	Decay	0.00-10 Sec	Amplifier envelope decay time
Amplifier Env	Sustain	0.00-100%	Amplifier envelope sustain level
Amplifier Env	Release	0.00-10 Sec	Amplifier envelope release time
Envelope 1	Attack	0.00-10 Sec	Amplifier envelope attack time
Envelope 1	Decay	0.00-10 Sec	Amplifier envelope decay time
Envelope 1	Sustain	0.00-100%	Amplifier envelope sustain level
Envelope 1	Release	0.00-10 Sec	Amplifier envelope release time
Envelope 2	Attack	0.00-10 Sec	Amplifier envelope attack time
Envelope 2	Decay	0.00-10 Sec	Amplifier envelope decay time
Envelope 2	Sustain	0.00-100%	Amplifier envelope sustain level
Envelope 2	Release	0.00-10 Sec	Amplifier envelope release time
LFO 1	Sync	Options	When set to On, Oscillator 2 resets on each cycle of Oscillator 1 (Osc 1 controls pitch).
LFO 1	Ratio	0-100 Hz	
LFO 1	Waveform	Options	Modulation wave shape: Triangle; Sin; Ramp Up; Ramp Down; Square; Random S&H
LFO 1	Retrigger	Options	Waveform retrigger: Free running will continuously run; One Shot will cycle once when a note is triggered; Note will trigger from the start and continuously run each time a note is triggered.
LFO 2	Sync	Options	When set to On, Oscillator 2 resets on each cycle of Oscillator 1 (Osc 1 controls pitch).
LFO 2	Ratio	0-100 Hz	
LFO 2	Waveform	Options	Modulation wave shape: Triangle; Sin; Ramp Up; Ramp Down; Square; Random S&H
LFO 2	Retrigger	Options	Waveform retrigger: Free running will continuously run; One Shot will cycle once when a note is triggered; Note will trigger from the start and continuously run each time a note is triggered.



Continued

Function	Parameter	Range	Description
Modulation	Src 1	Options	Modulation source options: Amp Env; Env1 (ftr); Env2; LFO1; LFO2
Modulation	Dest 1	Options	Modulation destination options: Osc1 Pitch; Osc2 Pitch; Op1 Shape; Op2 Shape; Op1 Feedback; Op2 Feedback; Op21 Feedback; FM; Filter Cutoff; Amp Env Sustain; Filter Env Sustain; Wave Env Sustain; Volume; Filter Env Decay.
Modulation	Amt 1	-100% to 100%	Modulation amount
Modulation	Src 2	Options	Modulation source options: Amp Env; Env1 (ftr); Env2; LFO1; LFO2
Modulation	Dest 2	Options	Modulation destination options: Osc1 Pitch; Osc2 Pitch; Op1 Shape; Op2 Shape; Op1 Feedback; Op2 Feedback; Op21 Feedback; FM; Filter Cutoff; Amp Env Sustain; Filter Env Sustain; Wave Env Sustain; Volume; Filter Env Decay.
Modulation	Amt 2	-100% to 100%	Modulation amount
Modulation	Src 3	Options	Modulation source options: Amp Env; Env1 (ftr); Env2; LFO1; LFO2
Modulation	Dest 3	Options	Modulation destination options: Osc1 Pitch; Osc2 Pitch; Op1 Shape; Op2 Shape; Op1 Feedback; Op2 Feedback; Op21 Feedback; FM; Filter Cutoff; Amp Env Sustain; Filter Env Sustain; Wave Env Sustain; Volume; Filter Env Decay.
Modulation	Amt 3	-100% to 100%	Modulation amount
Modulation	Src 4	Options	Modulation source options: Amp Env; Env1 (ftr); Env2; LFO1; LFO2
Modulation	Dest 4	Options	Modulation destination options: Osc1 Pitch; Osc2 Pitch; Op1 Shape; Op2 Shape; Op1 Feedback; Op2 Feedback; Op21 Feedback; FM; Filter Cutoff; Amp Env Sustain; Filter Env Sustain; Wave Env Sustain; Volume; Filter Env Decay.
Modulation	Amt 4	-100% to 100%	Modulation amount
Modulation	Src 5	Options	Modulation source options: Amp Env; Env1 (ftr); Env2; LFO1; LFO2
Modulation	Dest 5	Options	Modulation destination options: Osc1 Pitch; Osc2 Pitch; Op1 Shape; Op2 Shape; Op1 Feedback; Op2 Feedback; Op21 Feedback; FM; Filter Cutoff; Amp Env Sustain; Filter Env Sustain; Wave Env Sustain; Volume; Filter Env Decay.
Modulation	Amt 5	-100% to 100%	Modulation amount

5 Samples & Synths

NOTES



Continued

Function	Parameter	Range	Description
Modulation	Src 6	Options	Modulation source options: Amp Env; Env1 (fltr); Env2; LFO1; LFO2
Modulation	Dest 6	Options	Modulation destination options: Osc1 Pitch; Osc2 Pitch; Op1 Shape; Op2 Shape; Op1 Feedback; Op2 Feedback; Op21 Feedback; FM; Filter Cutoff; Amp Env Sustain; Filter Env Sustain; Wave Env Sustain; Volume; Filter Env Decay.
Modulation	Amt 6	-100% to 100%	Modulation amount
Voice	Glide Mode	Options	Slide between notes: Always, Overlap, Legato i.e. Envelopes are not triggered, Legato Overlap
Voice	Glide Time	0.00 - 3 Sec	Time of slide between notes.
Voice	Volume	0-200%	Volume level of oscillator voice
Macros	Attack		Default Macro for the sample attack knob
Macros	Decay/ Release		Default Macro for the sample decay knob
Macros	Op Shape		Default Macro for the bit depth knob
Macros	Filter Cutoff		Default Macro for the filter cutoff knob
Macros	Filter Resonance		Default Macro for the filter resonance knob
Macros	Filter Env Amount		Default Macro for the overdrive knob
Macros	Velocity		Default Macro for the volume knob

PERC™

The Kick percussion element is triggered with note C4 in a pattern.

Function	Parameter	Range	Description
Kick	Model	Options	Classic8, Synced8, Classic9
Kick	Pitch	C0-B8	Pitch of kick based on note values.
Kick	Body Wave	Options	Sat-Sin 0%-100%, Triangle 0%-100%, Square 0%-100%, Square FM 0%-100%, FM1 0%-100%, FM3 0%-100%, FM7 0%-100%, FM 11 0%-100%, tzFM1 0%-100%, txFM3 0%-100%, tzFM7 0%-100%, txFM11 0%-100%, Glitch 1 0%-100%, Glitch 2 0%-100%, Glitch 3 0%-100%, Glitch 4 0%-100%
Kick	Body Attack	0-10 ms	Attack stage time of kick transient
Kick	Body Decay	0-10 Sec	Decay stage time of kick transient
Kick	Mod Decay	0-10 Sec	Modulation decay time
Kick	Mod Amount	-100 to +100	Modulation amount applied
Kick	Transient Timbre	-100 to +100	Timbre sound characteristic of transient
Kick	Transient Level	0-100%	Level setting of transient

The Toms percussion elements are triggered with notes C0-B3, C5+ in a pattern.

Function	Parameter	Range	Description
Toms	Model	Options	Classic, Classic+, Resonant
Toms	Body Wave	Options	Sat-Sin 0%-100%, Triangle 0%-100%, Square 0%-100%, Square FM 0%-100%, FM1 0%-100%, FM3 0%-100%, FM7 0%-100%, FM 11 0%-100%, tzFM1 0%-100%, txFM3 0%-100%, tzFM7 0%-100%, txFM11 0%-100%, Glitch 1 0%-100%, Glitch 2 0%-100%, Glitch 3 0%-100%, Glitch 4 0%-100%
Toms	Body Attack	0-10 ms	Attack stage time of kick transient
Toms	Body Decay	0-10 Sec	Decay stage time of kick transient
Toms	Mod Decay	0-10 Sec	Modulation decay time
Toms	Pitch Mod	-1000 to 1000	Pitch modulation
Toms	Wave Mod	-100 to +100	Modulation amount applied
Toms	Transient Timbre	0-200	Timbre sound characteristic of transient
Toms	Transient Level	0-100%	Level setting of transient

5 Samples & Synths



Continued

The Snare percussion element is triggered with note D4 in a pattern.

Function	Parameter	Range	Description
Snare	Model	Options	Classic8, Classic9, Classic9+, Modern, Modern+
Snare	Pitch	C0-B8	Pitch of snare based on note values.
Snare	Tone	0-100%	Snare tone
Snare	Body Wave	Options	Sat-Sin 0%-100%, Triangle 0%-100%, Square 0%-100%, Square FM 0%-100%, FM1 0%-100%, FM3 0%-100%, FM7 0%-100%, FM 11 0%-100%, tzFM1 0%-100%, txFM3 0%-100%, tzFM7 0%-100%, txFM11 0%-100%, Glitch 1 0%-100%, Glitch 2 0%-100%, Glitch 3 0%-100%, Glitch 4 0%-100%
Snare	Body Decay	0-10 Sec	Decay stage time of snare transient
Snare	Snap Attack	0-10 ms	Attack stage time of snare snap
Snare	Snap Decay	0-10 Sec	Snap decay time
Snare	Snap Timbre	0-100%	Timbre sound characteristic of snap stage
Snare	Body/Snap Mix	-100 to +100	Balance of snap and body tones

The Hi Hat percussion elements are triggered with notes E4-G4 in a pattern.

Function	Parameter	Range	Description
Hi Hat	Model	Options	Classic, FM
Hi Hat	Timbre	0-24	Timbre sound characteristic
Hi Hat	Closed Decay	0-10 Sec	Decay stage time of open hi hat
Hi Hat	Open Decay	0-10 Sec	Decay stage time of closed hi hat
Hi Hat	Decay Shape	0-100%	Shape of decay curve
Hi Hat	HPF Cutoff	10Hz - 20kHz	High pass filter cutoff frequency
Hi Hat	LPF Cutoff	10Hz - 20kHz	Low pass filter cutoff frequency
Hi Hat	Tone Pitch	100 - 880Hz	Pitch in Hz of the Hi Hat Tone stage
Hi Hat	Tone/Noise Mix	-100 to +100	Balance of hi hat noise and tone

PERC™

Continued

The Cymbal percussion element is triggered with note A4 in a pattern.

Function	Parameter	Range	Description
Cymbal	Model	Options	Classic, FM
Cymbal	Timbre	0-24	Timbre sound characteristic
Cymbal	Body Filter	500Hz-10kHz	Frequency of body stage
Cymbal	Impact Filter	500Hz-10kHz	Frequency of impact stage
Cymbal	Body Decay	0-10 Sec	Decay time of body stage
Cymbal	Impact Decay	0-10 Sec	Decay time of impact stage
Cymbal	Tone Pitch	80Hz-880Hz	Tone in Hz
Cymbal	Tone/Noise Mix	-100 to +100	Balance of cymbal noise and tone
Cymbal	Impact/Body Mix	-100 to +100	Balance of cymbal impact and body stage

The other Percussion elements are triggered with notes B4 in a pattern.

Function	Parameter	Range	Description
Percussion	Model	Options	Clap, Clap+, Maracas, Shaker, Cowbell
Percussion	Variation	0-100	Variation of the percussion sound
Percussion	Timbre	0-100	Timbre tone character
Percussion	Decay	0-2 Sec	Decay stage time of the percussion element

5 Samples & Synths

NOTES

PERC™

Continued

Function	Parameter	Range	Description
Mixer	Kick Level	0-200	Volume level
Mixer	Kick Pan	L100-R100	Stereo panning left to right
Mixer	Kick Delay	0-100	Delay send
Mixer	Kick Reverb	0-100	Reverb send
Mixer	Kick Level	Options	Main, Post Overdrive, Post EQ
Mixer	Tom Level	0-200	Volume level
Mixer	Tom Pan	L100-R100	Stereo panning left to right
Mixer	Tom Delay	0-100	Delay send
Mixer	Tom Reverb	0-100	Reverb send
Mixer	Tom Level	Options	Main, Post Overdrive, Post EQ
Mixer	Snare Level	0-200	Volume level
Mixer	Snare Pan	L100-R100	Stereo panning left to right
Mixer	Snare Delay	0-100	Delay send
Mixer	Snare Reverb	0-100	Reverb send
Mixer	Snare Level	Options	Main, Post Overdrive, Post EQ
Mixer	Hi Hat Level	0-200	Volume level
Mixer	Hi Hat Pan	L100-R100	Stereo panning left to right
Mixer	Hi Hat Delay	0-100	Delay send
Mixer	Hi Hat Reverb	0-100	Reverb send
Mixer	Hi Hat Level	Options	Main, Post Overdrive, Post EQ

Function	Parameter	Range	Description
FX	Waveshaper Type	Options	Saturate, Overdrive, Overdrive+, Bitcrush, Bitcrush+
FX	Waveshaper Level	0-100	Volume level of waveshaper
FX	EQ Low 80Hz	-18dB to +18dB	Boost or attenuate in dB at 80Hz
FX	EQ Mid 2.5kHz	-18dB to +18dB	Boost or attenuate in dB at 2.5kHz
FX	EQ High 12kHz	-18dB to +18dB	Boost or attenuate in dB at 12kHz

PERC™

Continued

Macro options are repeated per Modulation slot.

Function	Parameter	Range	Description
Macro	Macro Name	Editable	Select edit to use naming editor
Macro	Bipolar	On or Off	Selects bipolar on or off for the macro control
Macro	Parameter 1	Options	Target parameter options from the synth engine to control with the macro.
Macro	Amount 1	-2 to +2	Amount of modulation range applied
Macro	Parameter 2	Options	Target parameter options from the synth engine to control with the macro.
Macro	Amount 2	-2 to +2	Amount of modulation range applied
Macro	Parameter 3	Options	Target parameter options from the synth engine to control with the macro.
Macro	Amount 3	-2 to +2	Amount of modulation range applied
Macro	Parameter 4	Options	Target parameter options from the synth engine to control with the macro.
Macro	Amount 4	-2 to +2	Amount of modulation range applied
Macro	Parameter 5	Options	Target parameter options from the synth engine to control with the macro.
Macro	Amount 5	-2 to +2	Amount of modulation range applied

Perc Synth Notes

PERC is a unique instrument as part of the synth family for Play+. While this is described as a percussion instrument it is a collection of instruments contained in one function and serves to take inspiration from a series of classic drum instruments. Some additional notes are provided.

Kick

Classic8 vs Synced8 model - Synced8 resets the oscillator for each note, resulting in a predictable transient, but can click when notes overlap. Classic, as in the TR-808, does not reset the oscillator, so the transient can be slightly different each time (especially for short Attack times).

Body Wave - sets the wavetable used and baseline position in the wavetable. All wavetables start from a sine wave (at 0%) but end differently (at 100%).

5 Samples & Synths

Mod Amount - the amount of modulation by the Mod envelope. In the Classic9 model - pitch is modulated, in the Classic8/Synced8 wavetable position is modulated.

Transient Timbre - the transient is an impulse (for positive values of the parameter) or a short burst of noise (for negative values) that is then passed to a LP filter. The absolute value of the parameter sets the cutoff of the filter (0 -> 30 Hz, -1/1 -> 4 kHz). Negative values make the transient to be different each time (the noise burst is generated for each trigger).

Tom

Models - Classic is a single oscillator, inspired by the TR-808, and Classic+ adds a noise transient. Resonant is based on 3 detuned oscillators like the TR-909, with the same noise transient.

Body Wave - same as in the kick.

Pitch Mod / Wave Mod - see Mod Amount in the kick, except that both can be set independently of the model.

Transient Timbre - sets the cutoff of a LPF, that filters white noise (constant noise, not a burst as in the kick).

Snare

The models differ in how filters and oscillators are configured (including pitch modulation). It's best to just listen to the differences. The names are also a hint :).

Tone sets the balance between oscillators of the body.

Body Wave - same as Kick/Tom (wave position is not modulated) Snap Timbre - cutoff frequencies of snap part filters.

Hihat and Cymbal

Model - Classic is based on 6 square oscillators, based on TR-808, FM is an 2-op FM oscillator. Both add white noise.

Timbre - sets either relative tuning of the square oscillators or a preset configuration of the FM algorithm. A value of 12 is a good starting point and is the best match of TR-808.

Perc

Velocity values 0-100 affect volume and values 100-127 have an extra accent effect, depending on the part (e.g. shortening envelope, changing mix of components).

Velocity macro should not be used, it will work the same regardless of the note triggered.

5.10 Synthesizer Macros.

Each patch has a number of parameters that are assigned to 3 of the panel knobs. A macro therefore will control this group of parameters collectively when adjusting a single knob. Macros are assigned and range mapped as part of the patch.

Structure of a Macro
 Example: Overdrive Macro Mapping for ACD

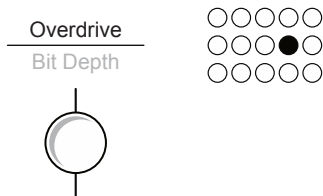

Macro Name	'Filter env amount'	<i>Name which appears on the display</i>
Bipolar	On	<i>Knob range On -63 to +64, Off 0-127</i>
Parameter 1	Env amt	<i>Parameter that the knob will affect</i>
Amount 1	0.00	<i>Starting value from which macro will adjust</i>
Parameter 2		<i>Parameter that the knob will affect</i>
Amount 2	0.00	<i>Starting value from which macro will adjust</i>
Parameter 3		<i>Parameter that the knob will affect</i>
Amount 3	0.00	<i>Starting value from which macro will adjust</i>
Parameter 4		<i>Parameter that the knob will affect</i>
Amount 4	0.00	<i>Starting value from which macro will adjust</i>
Parameter 5		<i>Parameter that the knob will affect</i>
Amount 5	0.00	<i>Starting value from which macro will adjust</i>

A macro is controlled by one knob function but can change up to 5 parameters. These are mapped in the patch editor. The starting point is the value as assigned in the patch which also contributes to determining the range of the value change.

5 Samples & Synths

The control knob for the macro operates over a range of 0-127 or -63 to 64 if a bipolar range is set. This will be applied to each of the macro destinations where the macro amount determines the actual parameter range and the patch parameter to default starting point.

Macro Range

Example: Volume Macro Mapping for ACD Velocity

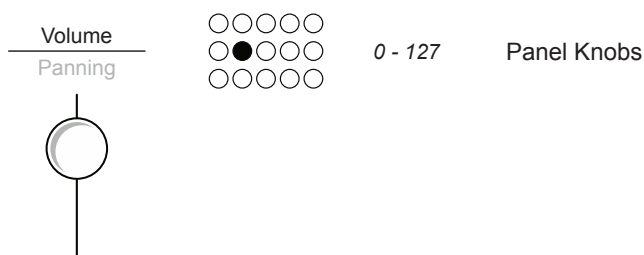

Macro

Macro Name	'Velocity'	
Bipolar	Off	<i>Knob range 0-127</i>
Parameter 1	Voice Volume	<i>Parameter that the knob will affect</i>
Amount 1	1.00	<i>Multiplier of generated value</i>
etc		

Patch

Start Point 100%

e.g. 2.00 x 100% would double the sound, effectively +6dB of perceived loudness

Synths > Synth 1 (ACD)

Voice

Glide Mode	Glide Mode	Volume
_____	_____	_____
Back	Play	

A macro is controlled by one knob function but can change up to 5 parameters. These are mapped in the patch editor.

The Macro knobs are available when in MIDI / Synth mode

NOTES

Randomize & Chance

The Macro that is set to 'Filter Cutoff' will also be affected by the Chance or Randomize function. This is applied when in MIDI/Synth mode and also when a synth is selected as the sound.

For Chance the action should be set to Rnd Cutoff CC for the chance function to control the filter cutoff macro.

For Randomize, the Randomize Type should be set to 'Filter CC/Macro' in order to control the filter cutoff macro.

6

Sequencing Patterns

Play+ is a groovebox aimed at making and performing songs and arrangements quickly. The 'Pick & Place' principles of Play+ encourage a quick and easy selection of a sample or synth and setting of parameters and then placing these instruments into steps in a pattern using sequencer mode. The workflow in creating patterns supports this aim with quick and simple processes and tools which automate music production and sound design while still retaining user control and creativity. Each project contains a maximum of 128 patterns each with 8 tracks for samples and 8 tracks for MIDI / Synths and a maximum of 64 steps per track. The process for the creation of patterns and subsequently the performing of songs is what makes Play+ different from other grooveboxes. Steps are the building blocks when creating patterns. Steps are populated with samples, synths or MIDI notes across the pattern to create arrangements of beats and

melodies. MIDI is covered in a later section. Patterns can play in multiple ways. Steps are played in series across the defined direction while tracks play together in parallel. Think of a Pattern as a bite size element of a full song. Patterns can be combined and arranged together for chaining into a full length track and variations of patterns is possible to add even more interest. This section will focus on patterns used in audio sample tracks. The same basic process also applies to the creation of Synth and MIDI patterns. This section will provide overall guidance on creating patterns as well as their general structural elements. Patterns are the foundation of working with Play+ and are created in sequencer mode. All the basic building blocks and the process needed to get started in creating, editing and using a basic pattern are covered in this section.

6 Sequencing Patterns

6.1 What's a Pattern?

NOTES

A pattern is a combination of 8 audio and 8 MIDI / Synth tracks where each has a series of steps mapped out. Audio steps can contain a sample or synth which allows the formation of a melody or beat. So for example Track 1 could be the Drums, Track 2 for Percussion, Track 3 as Bass etc. A pattern can be created by: adding steps manually 'programmed' into the grid pad; recording in real time; automatically sequencing with the fill tool. Patterns can be played individually or chained together into a sequence.

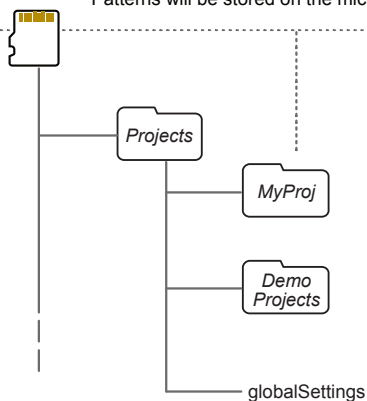
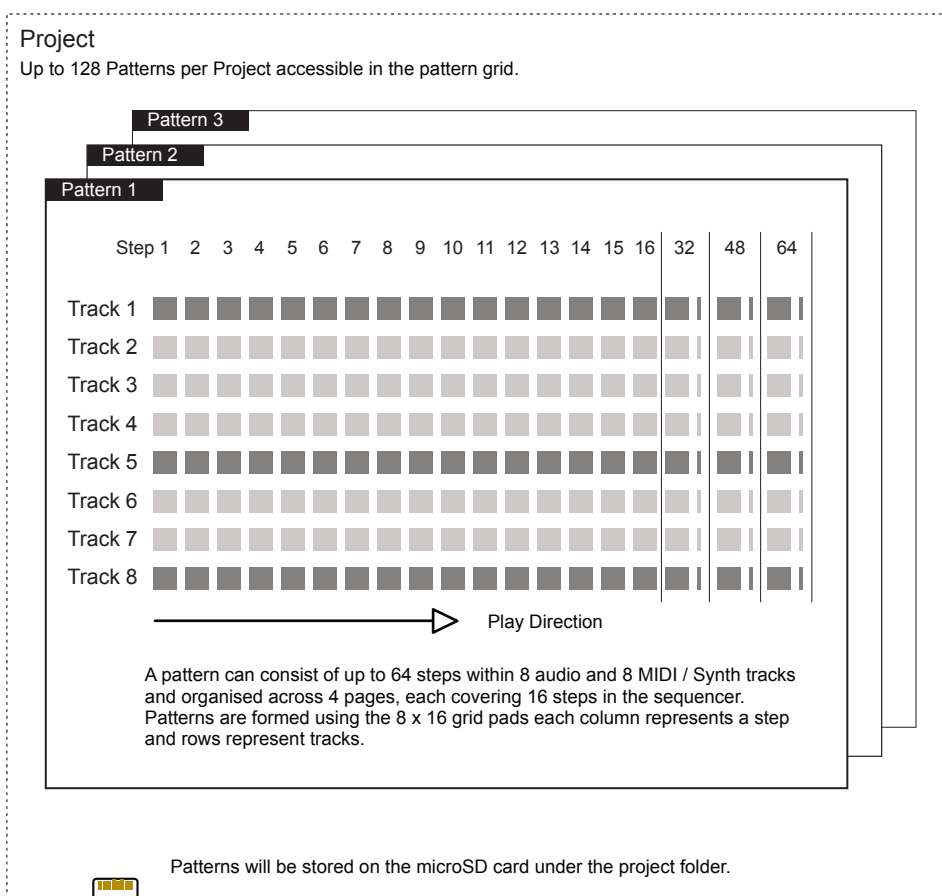

6.2 The Play+ Grid.

The grid is a multi-functional 8 x 16 button matrix used for various functions. When working with patterns the grid can operate in sequencer mode or pattern mode. Sequencer mode allows the creation and editing of individual patterns across 8 tracks in audio sample or MIDI / Synth modes and a maximum of 64 steps. This is the normal default view. Pattern mode helps manage the entire set of patterns, where each grid button represents one of the 128 individual patterns available within each project.

Default view is Sequencer Mode. Press [Patterns] to switch to Pattern Mode.

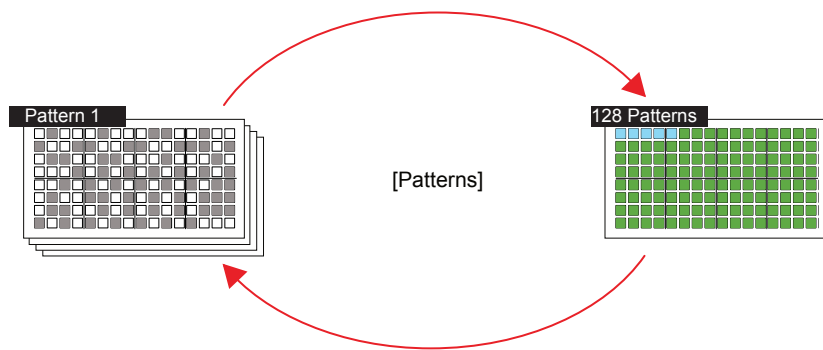

Sequence Mode.

Edit and add steps, build melodies and beats. Sequence a single pattern across the tracks with up to 64 available steps.

Pattern Mode.

Chain and organise up to 128 patterns across the grid. Arrange and play chained loops or individual patterns.

Last four columns 17-20 are function buttons that control pattern / track options. This is available in pattern mode, sequencer mode and also when in perform mode.

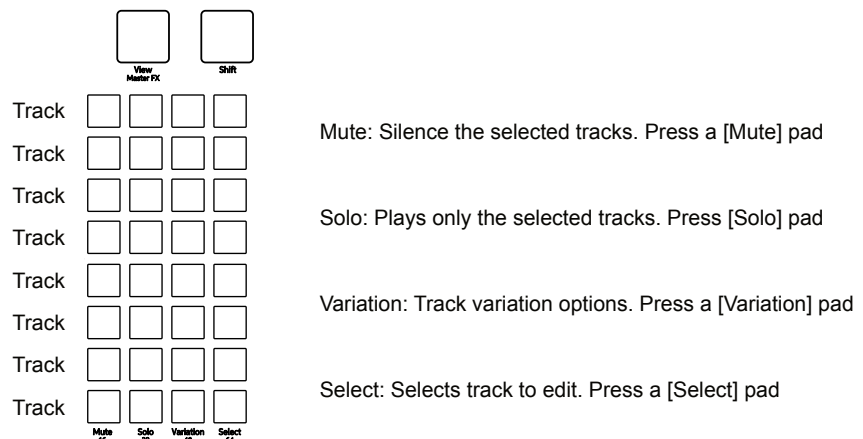

6 Sequencing Patterns

6.3 Sequencer Mode.

NOTES

Sequencing mode grid allows sequencing of patterns by adding note steps. Each row represents a track. The grid consists of 8 rows with 16 columns of pad buttons. The function of the pads depends on the mode selected. The first 16 columns left to right represent the pattern steps. The final 4 right side columns represent function pads, used to control mute, solo, variation and selection of each of the tracks. The function pads can also be used to set the pattern length and view each pattern page.

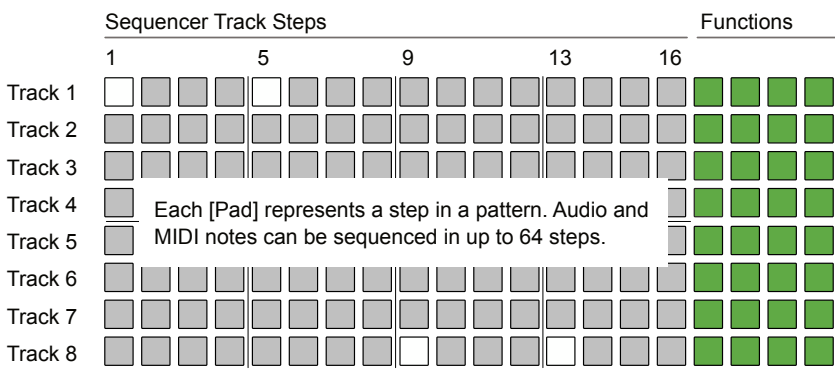

To play the current pattern: Press [*Play*]

Mute: Silence the selected tracks. Press [Pad]
16: Step Page 1 - Steps 1-16 - Press [Shift] + [Pad]







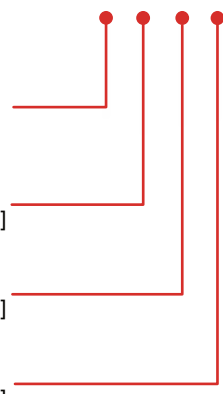

Solo: Plays only the selected tracks. Press [Pad]
32: Step Page 2 - Steps 17-32 - Press [Shift] + [Pad]

Variation: Track variation options. Press [Pad]
48: Step Page 3 - Steps 33-48 - Press [Shift] + [Pad]

Select: Selects track to edit. Press [Pad]
64: Step Page 4 - Steps 49-64 - Press [Shift] + [Pad]



Sequencer - 8x16 Grid Pad Colors

-  Off. Step is empty and does not trigger any event. Tap [Pad].
-  White. Step has an active sample or MIDI note event. Tap [Pad].
-  Violet. Step has an active Synth 1 note event. Tap [Pad].
-  Yellow. Step has an active Synth 2 note event. Tap [Pad].
-  Green. Step has an active Synth 3 note event. Tap [Pad].
-  Blue. Selected, note event step. Hold [Shift] + [Pad].
-  Dim Blue. Selected, empty step. Hold [Shift] + [Pad].
-  Orange. Playhead on currently active step for a track. [*Play*].
-  Red. Playhead on currently active step - Live Rec Mode. [*Play*].

6.4 Introduction to Pattern Mode.

Pattern mode also uses the multi-functional 8 x 16 grid. The normal default view is sequencing mode where an individual pattern is created or edited. Pattern mode offers control over the entire set of 128 patterns, where each grid button represents an individual pattern in a project.

A pattern should be selected for editing and sequencing. By default pattern 1 represented by the first, upper left pad is selected. Patterns can be copied and pasted in pattern mode. In pattern mode, patterns can be chained for sequential playback all together or in sections.

Press [Patterns] to access the Pattern Mode.

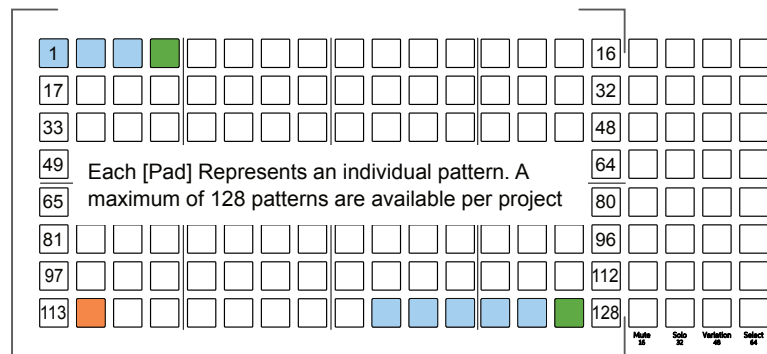

The currently active pattern is lit ■ Orange and other available patterns lit ■ Blue. Dimmed ■ Green Pads signify empty patterns. Flashing pads indicate a pattern pending play.

To play a chained series of patterns: Hold [Shift] + Press [Play]

SELECTING PATTERNS IN PATTERN MODE

1. Press [Patterns] from sequencer mode to select pattern mode. If in pattern mode already, pressing [Patterns] will toggle to the sequencer mode.
2. To select a pattern, Press [Pad] for the pattern to edit or play. Pads are laid out across the 8 x 16 grid with a total of 128 pattern slots available. Empty patterns are dimmed green, available patterns are blue and the currently active pattern will be lit orange.
3. The selected pattern can now be played or edited in sequencing mode, selected by pressing [Patterns] from pattern mode.

6 Sequencing Patterns

6.5 Pick & Place to Create A Pattern.

NOTES

The first step in sequencing a pattern in Play+ is to pick a sample or synth and place it on the sequencer grid. This will populate steps in order to build a melody or a beat. General selection of a sample or synth and adjustments of its base parameters creates a work step. Subsequent placement into steps on the grid will populate each step selected with the same work step settings. This is performed in sequencer mode. All 3 Synths as well as samples can be combined together into a pattern.

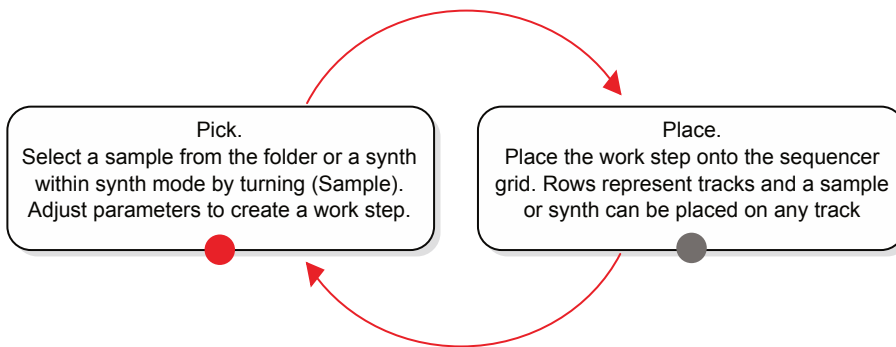

- 1 Select Pattern**
Press [Patterns] and select from the pattern grid a pattern to work on. Pattern 1 top left. Press [Patterns] to switch back to sequencer mode to create the pattern steps.

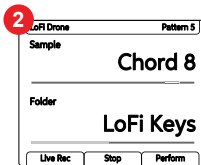

2 Select Sample / Synth
Tap and Turn (Sample) to select. Double tap to select and turn to change the sample folder or the synth patch.

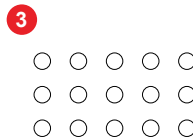

3 Adjust Parameters
Adjust the sample or synth related parameters in order to create a general work step ready for placement.

- 4 Ensure Sequencer Mode**
Ensure sequencing mode is visible. Press [Patterns] or [Perform] to switch back from pattern and perform mode views. Pattern mode is used only to manage all patterns.

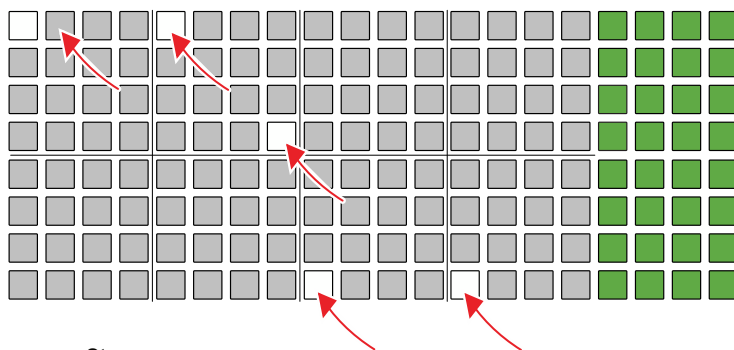

- 5 Sequence Steps**
Tap on each desired grid steps to place the work step and create note steps. Empty steps are unlit and note steps are lit white for samples or colored respective to each synth. The sample or synth and settings are identical on each step placed.

■ PICKING & PLACING A SAMPLE OR SYNTH

1. Ensure sequencing mode is selected. If pattern mode or perform mode is selected, Press [Patterns] or [Perform] respectively to toggle back to Sequencer mode. This is the grid view which allows an individual pattern to be sequenced.
2. Pick a Sample / Synth:-
 - Double Tap (Sample) to switch to the folder - (Folder) parameter. Turn (Folder) to browse the sample folders or a patch if a synth device is selected. Any folders that are empty will not be displayed. Select a desired sample folder or patch.
 - Turn (Sample) to browse and select the sample in the current folder or to select one of three synths when in MIDI / Synth mode. If the pattern is not playing, the audio will be previewed audibly when a sample is selected.
 - The left side [Screen] buttons will also select between the two parameters and turning the (Screen) knob will also change the selected parameter. This is equivalent to using the parameter knob.
3. Adjust the parameters to establish the work step settings. The sample and parameters will be applied to any step placed on the grid.
4. Place the Sample / Synth as a note step.
 - Tap one or more pads to place the step. The sample or synth and the parameter settings of the work step will be applied on each step where the sample is placed.
 - Active note steps are lit white for samples. Empty steps are unlit. If a synth is being placed the pad color is reflected for each synth.
 - Steps can be placed on any track row and in any of the pattern columns. Note that the grid shows 16 steps across 8 tracks. There maybe other step pages selectable with the [Shift] + [16], [32], [48] or [64]. A maximum of 64 steps is available.
 - Tapping an existing active note step will delete it from the grid.
5. Press [Play] to play the current pattern. Notes can be placed while the pattern is playing.

6 Sequencing Patterns

6.6 Work Step Options.

General selection of a sample or synth and selection of the base parameters creates a work step when no step or track is selected. Subsequent placement into steps on the grid will populate each step selected with the same work step settings. This allows a sample or synth and set of parameters to be pre-selected and then placed multiple times across a pattern and provide a fast workflow. The settings for each individual step can be changed later if required.

In addition an existing step on the grid can be 'copied' to create a work step by holding the existing active step for >1 Second.

Deselect all steps and tracks to revert back to editing the work step.

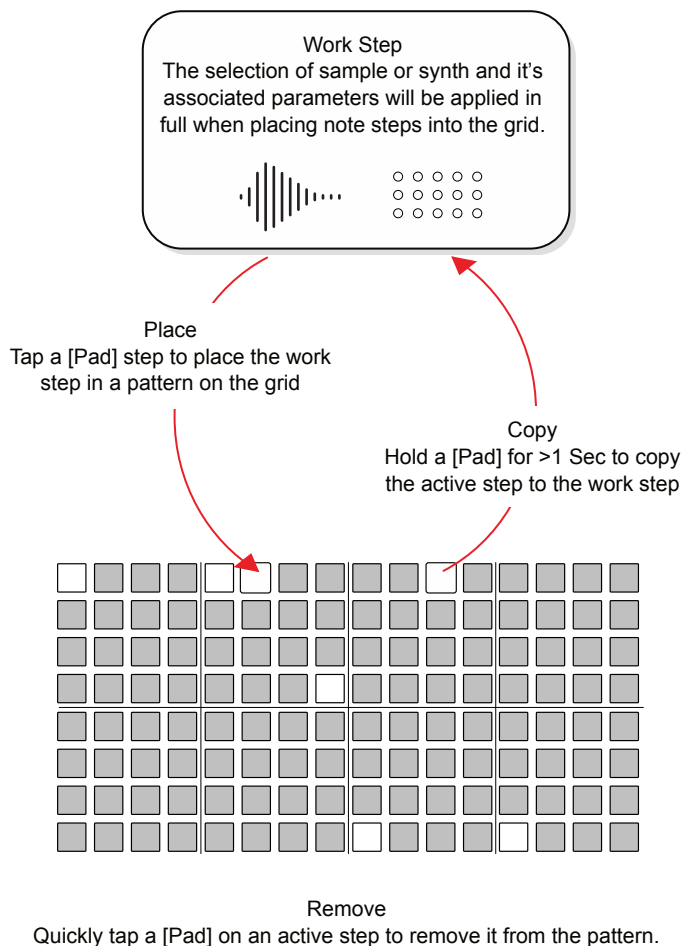

When creating a work step, any parameter adjustments made when the sequencer playback is stopped will be auditioned real-time

Parameters & Work Step Application

Parameter	Primary / Secondary	Work Step	Step	Track	Global
Master Volume	Primary	No	No	No	Yes
Limiter	Secondary	No	No	No	Yes
Tempo	Primary	No	No	Yes	Yes
Swing	Secondary	No	No	Yes	No (2)
Track Length	Primary	No	No	Yes	No (2)
Play Mode	Secondary	No	No	Yes	No (2)
Note	Primary	Yes	Yes	No (1)	No (2)
Microtune	Secondary	Yes	Yes	No (1)	No (2)
Volume	Primary	Yes	Yes	No (1)	No (2)
Pan	Secondary	Yes	Yes	No (1)	No (2)
Sample	Primary	Yes	Yes	No (1)	No (2)
Folder	Secondary	Yes	Yes	No (1)	No (2)
Sample Start	Primary	Yes	Yes	No (1)	No (2)
Sample End	Secondary	Yes	Yes	No (1)	No (2)
Sample Attack	Primary	Yes	Yes	No (1)	No (2)
Sample Decay	Secondary	Yes	Yes	No (1)	No (2)
Reverb Send	Primary	Yes	Yes	No (1)	No (2)
Delay Send	Secondary	Yes	Yes	No (1)	No (2)
Overdrive	Primary	Yes	Yes	No (1)	No (2)
Bit Depth	Secondary	Yes	Yes	No (1)	No (2)
Repeat Type	Primary	Yes	Yes	No (1)	No (2)
Repeat Grid	Secondary	Yes	Yes	No (1)	No (2)
Chance	Primary	Yes	Yes	No (1)	No (2)
Action	Secondary	Yes	Yes	No (1)	No (2)
Randomize	Primary	No	Yes	No (1)	No (2)
Randomize Type	Secondary	No	Yes	No (1)	No (2)
Move	Primary	No	Yes	No (1)	No (2)
Micromove	Secondary	No	Yes	No (1)	No (2)

(1) Parameter does not automatically change across a track, but with a track selected, by pressing [Select], then all active step parameters on the selected track can be edited relative to their original value.

(2) Parameter does not automatically change as a global setting across all steps. With all 8 tracks selected by pressing [Select], then all active step parameters can be edited relative to their original value.

6 Sequencing Patterns

6.7 Select & Adjust Step Editing.

NOTES

Steps individually or as a collective group that have already been placed into a pattern can be edited individually. Tracks can be selected which also allows the entire track to be edited where existing note step parameters are adjusted relative to their original value. Tracks and groups of steps can also be copied between Audio Sample and MIDI / Synth Tracks.

SELECTING BLOCKS OF MULTIPLE STEPS

1. Steps can be selected and held individually or collectively as a track. Also multiple steps across tracks can be selected as a block where a rectangular selection zone is used to select all steps contained within.
2. Ensure sequencing mode is selected. If pattern mode or perform mode is selected, Press [Patterns] or [Perform] respectively to toggle back to Sequencer mode. This is the grid view which allows an individual pattern to be sequenced.
3. Hold [Shift] + [Pad] 'A' for the first pad. Pad A is the first corner of the selection rectangle. Keep [Shift] + [Pad] held.
4. Press [Pad] 'B' for the second pad. This is while still holding [Shift] + [Pad] 'A'. Pad B is the second, diagonally opposite corner of the selection rectangle. The rectangular selection will be applied with blue pads and all note steps lit bright blue, within the block are selected for editing.
5. To remove or add the selection of individual steps within the block, Hold [Shift] and Tap [Pad] for the pad to remove from the rectangular selection block or to add to the block. Also applies when selecting tracks. This removes / adds only the selection and does not delete actual note steps.
6. To remove a selection, Tap [Shift]. The individual or multiple selection, not actual note steps, is removed. When no selection is active, the state reverts back to work step editing. If required, use [Shift] + [Fill] to Delete any note content within a selected area.
7. Parameter changes will apply to all steps selected. A tilde '~' symbol is displayed for a parameter where multiple values exist in the selection and adjustments will then show +/- as a offset from each individual step setting for the parameter.
8. To reset a selected parameter to its default, Double Tap [Screen] upper or lower left screen button for the parameter to reset.

Block Selection - Multiple Steps

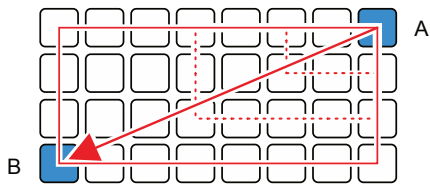
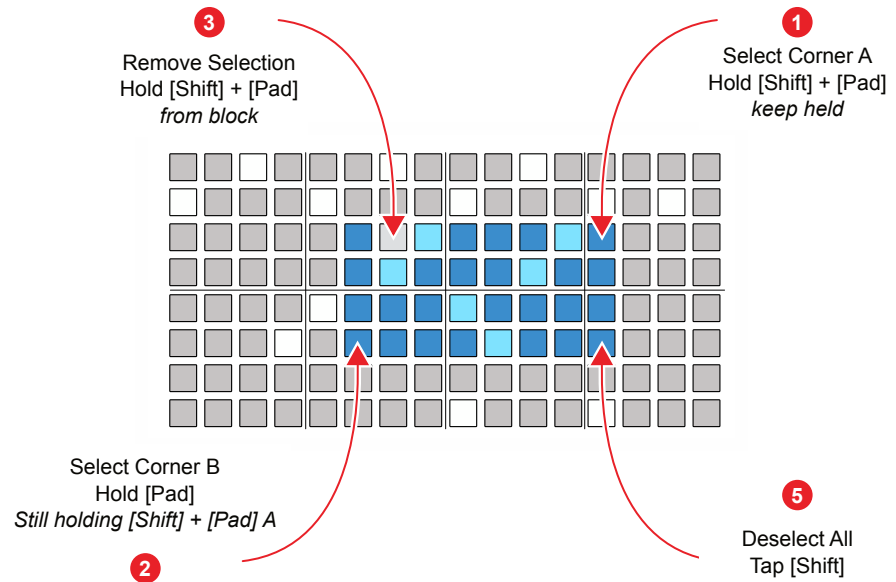

Zone selected will select all steps within the boundaries of the corner to corner selection block

- 4** Selected Steps can be edited by adjusting the parameter knobs. Multiple selections may have multiple values which displayed as '~' and adjustments will show '+/-' offset from its individual value.

Reset a parameter by double tapping the left side screen button for the displayed and active parameter.

The Move and Micromove parameter can relocate selected steps.

Selections can be deleted by pressing [Shift] + [Fill] for the delete command. The undo command, [Shift] + [Undo] can restore deleted steps. The selection of steps is retained but the content deleted.

6 Sequencing Patterns

EDITING INDIVIDUAL STEP PARAMETERS

1. Ensure sequencing mode is selected. If pattern mode or perform mode is selected, Press [Patterns] or [Perform] respectively to toggle back to Sequencer mode. This is the grid view which allows an individual pattern to be sequenced.
2. For the active step to edit, Hold [Pad] + Turn (Knob) for the parameter to edit. Multiple or blocks of steps can also be selected and held to adjust collectively.
3. If the sequencer is stopped, the step will be auditioned as the edit is performed.
4. Release the pad when complete. Take care to hold and not to briefly tap the pad as this will delete the step.
5. Double Tap [Screen] left or right screen button for the selected parameter in view to reset it to its default values.

EDITING ALL STEPS ON A TRACK

1. Ensure sequencing mode is selected. If pattern mode or perform mode is selected, Press [Patterns] or [Perform] respectively to toggle back to Sequencer mode. This is the grid view which allows an individual pattern to be sequenced.
2. Select the track to edit. Press [Select] green function pad. Selected pads are lit bright green (or purple in MIDI Mode). Multiple track rows can be selected.
3. Turn (Knob) for the parameter to edit. The parameter will be adjusted for all steps across all of the selected tracks. The parameter value is adjusted relative to the original value.
4. A '~' symbol in the parameter value indicates that multiple parameters are selected with different values. If values are all identical this value is displayed. A +/- value will be displayed as the offset from the original setting on the parameter display.
5. Double Tap [Screen] left or right screen button for the selected parameter in view to reset it to its default values.
6. To remove all selections, Tap [Shift]. Any selection, not actual note step, is removed. Use [Shift] + [Fill] to Delete a note step if required.

6.8 Copying & Pasting Steps.

Steps can be copied and pasted across the grid individually and also between complete tracks including between MIDI and Audio Tracks.

■ COPYING & PASTING STEP GROUPS

1. Ensure sequencing mode is selected. If pattern mode or perform mode is selected, Press [Patterns] or [*Perform*] respectively to toggle back to Sequencer mode.
2. Hold [Shift] + [Pad] for the active step to copy. Also use the block selection for group of steps if required. Selected pads lit blue.
3. Press [Copy] to copy the selection to the clipboard.
4. Select the destination step or group of steps to paste into using [Shift] + [Pad] or block selection equivalent shape to selected steps. This can be applied across tracks including MIDI, Synth and Audio Sample tracks.
5. Press [Shift] + [Paste] to paste from the clipboard.

■ COPYING & PASTING TRACKS

1. Ensure sequencing mode is selected. If pattern mode or perform mode is selected, Press [Patterns] or [*Perform*] respectively to toggle back to Sequencer mode. This is the grid view which allows an individual pattern to be sequenced.
2. Select the track to copy from. Press [Select] green function pad. Selected pads are lit bright green / purple. Multiple track rows can be selected.
3. Press [Copy] to copy the selected tracks and the active note steps.
4. Select the track to copy to. Press [Select] function pad. Selected pads are lit bright green or purple for MIDI / Synth. Multiple track rows can be selected. The originally selected tracks should be de-selected.
5. Hold [Shift] + [Paste] to paste the copied tracks into the selected tracks. The highest / upper track selected is the starting track to copy into and the formation of multiple tracks will be pasted in the same order.

Quick Copy: Note that quick copy can operate for steps, step pages, Patterns and Variations. Quick copy is performed by keep holding the source [Pad] for about half a second + Press [Pad] for any destination pads. Pads will flash blue twice when copied to the clipboard and when pasted.

6 Sequencing Patterns

6.9 Live Recording.

NOTES

Step recording allows manual placement of notes in the sequencer. Alternatively, live recording operates in real-time allowing notes and parameter adjustments to be recorded into the pattern as they are played.

Example: Audio Sample Track Live Recording

- 1 Select Tracks to Edit
Press [Select] function pad for the track to select. Selected tracks illuminate light green and grid blue.

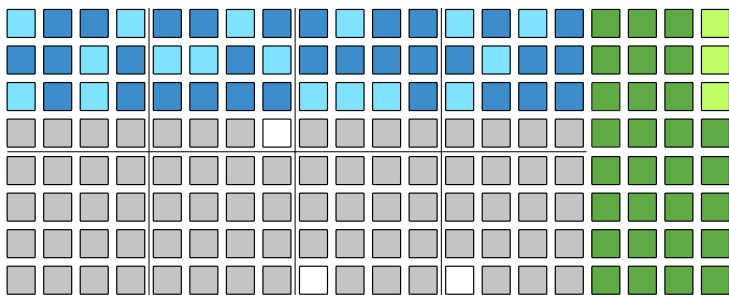

- 2 Select Live Rec
Press [Live Rec] Screen button to engage live recording mode. Screen button is lit red.

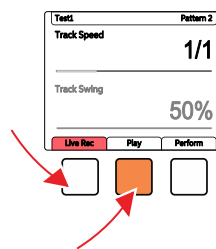

- 3 Play the Pattern
Press [Play] Screen button to play the pattern. Screen button shows playback progress bar.

- 4 To Add Notes
Press [View] to select the view controller. The right side 4 columns convert to an onboard MIDI keyboard. Play notes in. Alternatively use an external MIDI controller to play notes in.

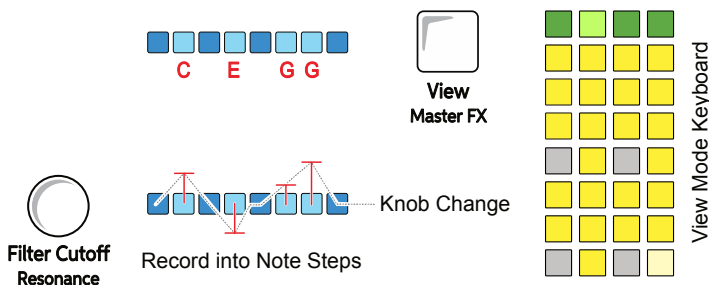

- 5 Record Parameter Changes
Turn (Parameter) knob to record in any parameter variations into the sequence time with the pattern steps. The (Screen) knob can also be used.

Notes can be recorded in when in Live Recording mode. If chords are played into audio tracks these are recorded per track for each note. MIDI tracks are polyphonic and operate differently. Parameter automation can also be recorded into note steps.

■ BASIC LIVE RECORDING PROCESS

1. Select the tracks to record into by pressing the function pad [Select] for the respective tracks. Rows represent tracks. The Track will illuminate blue and the track select function button bright green.
2. Press [Live Rec] Screen button. Live recording mode will be applied indicated by the red tag on the display.
3. Press [Play] to play the pattern so real-time recording can be performed. The cursor will be red when in live recording mode. If a track is longer than 16 steps, the playhead will follow / scroll to the next steps in the next page which may not be visible.
4. To record notes use either an external MIDI controller connected to Play+ or use the internal 'View' keyboard. Note that tapping a grid pad will exit the track selection.
5. Press [View] to select the view keyboard mode. The four right side pad columns will revert to the view keyboard controller. The pads will illuminate yellow. The upper green row controls the keyboard octave transposition.
6. Playing the view controller will record notes only into the selected tracks. Play+ has 8 audio tracks and as such chords recorded in will apply each note of the chord to a single track. For example, a triad chord will take up 3 of the 8 tracks.
7. To record a parameter change:-
 - Double tap a parameter knob while playing in record mode to change the highlighted parameter. When the knob is touched or moved the parameter changes will overwrite the current step data.
 - Parameter changes are only recorded into note steps.
 - Tap a knob to view its parameter setting. This will show a moving value during playback if automation has been recorded in.
 - Quickly double tap the selected parameter, left side screen button to reset its value to its default setting.

6 Sequencing Patterns

There are some recording parameters that can be configured in the main menu settings. These are Quantize recording which quantizes any played notes to the step division and the scale selected. Overdub recording which determines if existing data is retained or overwritten.

ADJUSTING LIVE RECORDING SETTINGS

1. Press the (Screen) Knob to open the main menu.
2. The previously selected menu location will be displayed. If not the main menu is not in view, use [Back] to navigate up the menu structure.
3. At the main menu level, highlight 'Settings' by turning (Screen). Press (Screen) to select the sub menu for settings.
4. Turn (Screen) to navigate the settings menu and to highlight the desired option.
5. For recording options choose Quantize Recording or Overdub Recording. When highlighted, Press (Screen) to show the options.
6. Both settings have the option to be turned 'On' or 'Off'. Defaults is off.
7. Turn (Screen) to highlight and choose between 'Off' and 'On'. Press (Screen) to confirm the selection.

Setting Option	Menu	Option	Description
Quantize Recording	Settings	Off	Will allow natural note placement with variable micro moves applied to establish the adjustment as played in position. Default setting.
		On	Will record note placement with fixed micro move setting applied to establish a more rigid grid sequence.
Overdub Recording	Settings	Off	Retains existing notes that already exist on steps. Records new notes into freely available steps. Existing notes are retained and new notes recorded ignored for a step with an existing note.
		On	Overwrites existing notes by any recorded new notes. Existing notes are replaced by any new note recorded onto the step and empty steps recorded with the note.

6.10 View Mode.

View mode presents an internal / virtual MIDI keyboard controller using the last four function pad rows. The keyboard can be changed to pad style in main menu configurations. The keyboard is laid out in two rows of keys to allow note entry in live recording mode. The notes applied are influenced by Play+ scale setting.

- 1 Select View Mode
Press [View] to select the view controller.



- 2 View Mode Keyboard
The right side 4 columns convert to an onboard MIDI keyboard to play notes in. Scale setting influences the view mode keyboard.

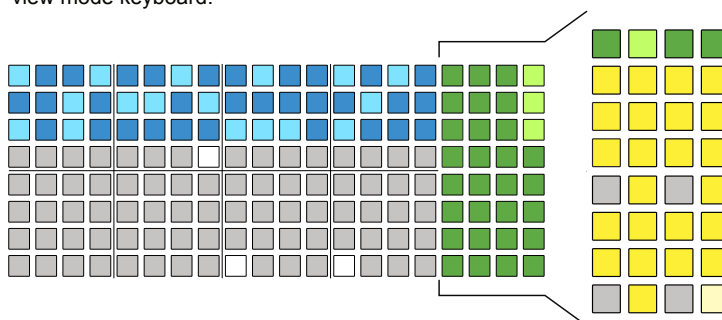

- 3 To Add Notes
Use the view pads to play and record notes in live mode. Green pads change the octave range for the keyboard.

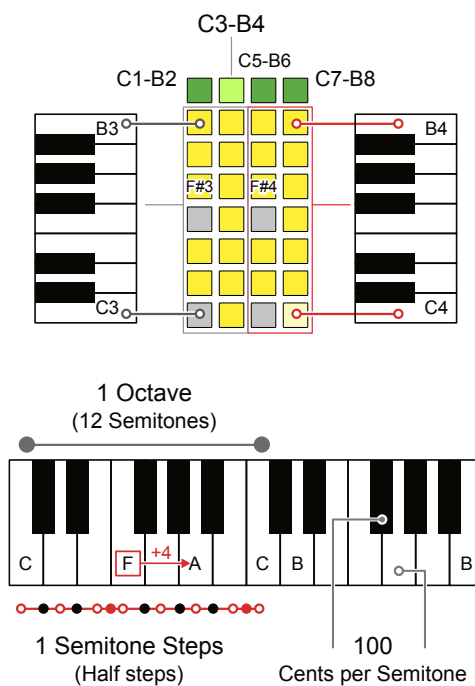

6 Sequencing Patterns

SELECTING VIEW MODE

1. Press [View] to select the view keyboard mode.
2. If in view mode, it will be deselected if then selecting perform mode.
3. The four right side pad columns will revert to the view keyboard controller. The pads will illuminate yellow. The upper row green pads, colored purple in MIDI / Synth mode, controls the keyboard octave transposition.
4. Press one of the green function buttons, top row to select an octave range for the view keyboard. The top left most pad covers 2 Octave range of notes C1-B2. Top right most pad covers 2 Octave range C7-B8. The central left and right buttons cover C3-B4 and C5-B6 ranges respectively.
5. The yellow pads are laid out in a keyboard format with each octave represented by the first two columns and second two columns. Bottom right most pad is note C and top right most pad note B. This is repeated for the other octave. White keys are represented by the 'Solo' and 'Select' columns and black keys by 'Mute' and 'Variation' columns. The view keyboard is influenced by the scale settings selected.

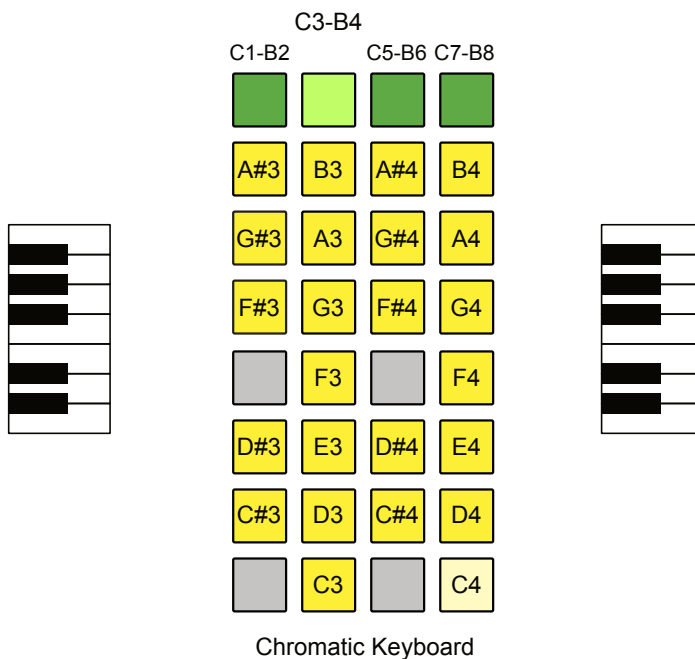

Default Scale: Chromatic Default Root Note: C

The octave range row pads are colored green in audio mode and purple in MIDI / Synth mode. The option to change from piano notes view to grid notes view is possible from within the main menu settings options.

PLAYING THE VIEW MODE KEYBOARD

1. Press [View] to select the view keyboard mode.
2. The four right side pad columns will revert to the view keyboard controller. The pads will illuminate yellow. The upper green row controls the keyboard octave transposition.
3. To assign a note when step sequencing:-
 - Ensure the work step is set correctly. For example a melodic sample i.e. piano is selected.
 - Press and hold the step to assign a note value.
 - While holding the step pad, press a note in the view mode keyboard. This will assign the last selected note to the step.
 - Repeat the process to build melodies across a track step pattern.
4. To assign a note when live recording:-
 - Ensure the work step is set correctly. For example a melodic sample i.e. piano is selected.
 - Select [*Live Rec*] mode and Press [*Play*].
 - Play the view mode keyboard. This will assign the notes being played into the sequence steps in real-time.
 - Patterns can be edited later, for example in step sequencing mode.
5. An external MIDI controller can be connected to perform the same functions as the view controller.

CHANGING VIEW MODE LAYOUT

1. Press (Screen) to select the main menu.
2. Turn (Screen) to scroll and highlight the sub menu options. Highlight 'Settings'. Press (Screen) to select this sub menu.
3. Turn (Screen) to scroll and highlight the options. Highlight 'View Layout'. Press (Screen) to select this option.
4. Turn (Screen) to scroll and highlight the options. Highlight either 'Piano Notes' or 'Grid Notes'. Press (Screen) to select the highlighted option.

6 Sequencing Patterns

6.11 Piano Roll.

The piano roll presents the 8x16 Pad grid in a keyboard note format where each row represents an individual note within the selected scale. Audio and MIDI sequencers can be created using the piano roll. The pads are laid out in note rows with the root note indicated by the pink pad rows. The notes applied are influenced by Play+ scale setting.

- 1** Select View Mode
 Hold [View] greater than 1 sec to select the Piano roll. Tracks must be selected as pre-requisite. The number of which will dictate the available voices / notes.



- 2** Piano Roll Keyboard
 The 8 rows convert to piano style notes. Pink rows show the root note. A maximum of 8 Voices can be selected i.e. 8 notes max.

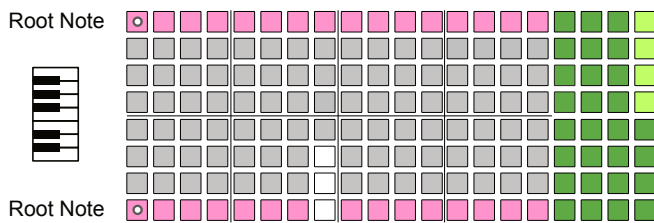

- 3** To Add Notes
 Use the grid pads to record notes. The available notes are dependant on the scale selected and scale filtering state. Rows are notes, columns are steps.

Examples: Root C, Scale Filter 'On', show notes in scale.

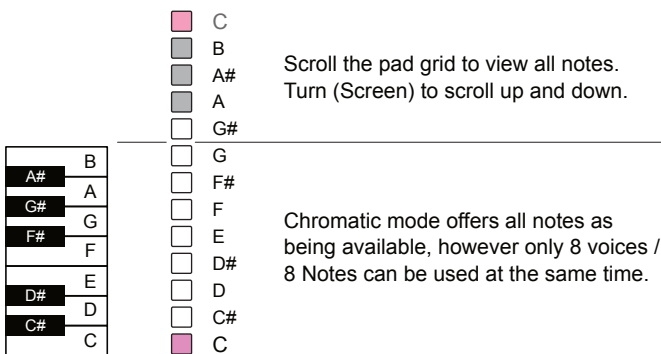

C Major

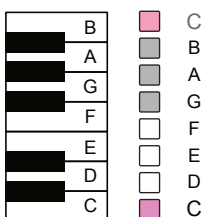

C Minor

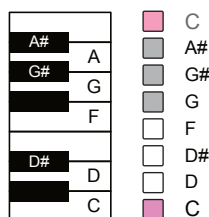

C Dorian

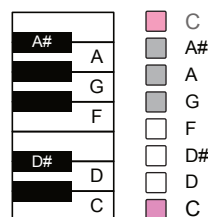

SELECTING THE PIANO ROLL

1. Quickly tap (Screen) button to open the settings options. The Scale setting need to be set which will be used for the piano roll layout.
2. Select 'Scales' by navigating and pressing (Screen) to select. Once the scale parameters are set, use [Back] to exit the settings menu.
 - Scale Filter - Typically set to 'On' to display the available notes
 - Scale - Select the scale for the notes.
 - Scale Root Note - Represented by the pink rows.
3. Press [Select] to choose a number of tracks. Each voice in the audio model is represented by a track. Each note requires one voice.
 - One track will allow one note, Two tracks for 2 notes and so forth. All tracks selected will represent all 8 notes.
 - Selected tracks must have the same length, speed, swing setting.
 - Variations and Step pages in the piano roll are synchronised for all selected tracks. Is one track is changed e.g. to 64 steps, then all selected tracks in the piano roll will follow to be set to 64 steps
4. Hold [View] to open the Piano Roll view. This is a longer press above 1 second duration. A short press only selects the view mode.
5. The piano roll is represented by the 8x16 pads. Each row represents a note in the selected scale. Turn (Screen) to scroll the notes.
 - The root note is represented by a row of pink note pads.
 - The number of notes selectable is based on the number of tracks selected. A triad chord requires 3 tracks. This is number of notes, not steps. A note can be programmed into several steps in the row.
 - The pad columns represent each step in the sequence.
 - Individual instruments can still be programmed per step.
4. Notes and chords can be programmed into the grid. Selected notes will illuminate white on the selected pads.
 - Tap [Shift] quickly to deselect / select the active steps
 - MIDI note length is reflected in the piano roll grid.

6 Sequencing Patterns

6.12 Scales.

NOTES

Play+ has a number of scales that can be set within the main menu. The default scale setting is Chromatic and Root note C. These can be changed from a selection of options and will influence the view mode keyboard as well as existing sequences and MIDI output. A scale filter option is also available which limits available notes to the selected scale and inputs / outputs only notes that fit the chosen scale. While the view mode keyboard will visual a chromatic style keyboard, the available notes are quantized to the scale when the scale filter is set to on.

Setting Option	Menu	Option	Description
Scale Filter	Scales	Off	Scales are applied with all respective notes available for the selected scale. Applied per project. Default Off.
		On	Notes available are limited to the notes in the scale currently selected. Applied per project.
Scale Type	Scales	Various	Select from a list of available scales
Scale Root Note	Scales	Various	Select from a list of available notes

Scale Type
Chromatic
Minor
Major
Dorian
Lydian Major
Lydian Minor
Locrian
Phrygian
Phrygian Dominant
Mixolydian
Melodic Minor
Harmonic Minor
BeBop Major
BeBop Dorian
BeBop Mixolydian
Blues Minor
Blues Major
Pentatonic Minor
Pentatonic Major
Hungarian Minor

Scale Type
Ukranian
Marva
Todi
Whole Tone
Diminish
Super Locrian
Hirajoshi
In Sen
Yo
Iwato
Whole Half
Kumoi
Overtone
Double Harmonic
Indian
Gypsy Minor
Neapolitan Major
Neapolitan Minor
Enigmatic

Scale Filter.

When filtered to a scale, the display will show when quantizing a note to one within the selected scale.

A#3 > B 3

■ APPLYING A SCALE AND SCALE FILTER

1. Press the (Screen) Knob to open the main menu.
2. The previously selected menu location will be displayed. If not the main menu is not in view, use [*Back*] to navigate up the menu structure.
3. At the main menu level, highlight 'Scales' by turning (Screen). Press (Screen) to select the sub menu for scales.
4. Turn (Screen) to navigate the scales menu and to highlight the desired option.
5. Scale Type.
 - Turn (Screen) to highlight 'Scale Type' then press (Screen) to select the options. Turn (Screen) to highlight and then press (Screen) to select a desired scale.
 - Scales will influence all existing sequences and MIDI output.
 - When changing track scales, notes on existing sequence steps are adjusted to the new scale by transposing up one or two semitones. Using a scale on an existing sequence will quantize the notes and chords to the new scale.
6. Scale Root Note.
 - Turn (Screen) to highlight 'Scale Root Note' then press (Screen) to select the options. Turn (Screen) to highlight and then press (Screen) to select a desired scale root note.
 - When changing track root, notes on existing sequence steps are adjusted to the new scale.
7. Scale Filter.
 - Turn (Screen) to highlight 'Scale Filter' then press (Screen) to select the options. Turn (Screen) to highlight and then press (Screen) to select scale filter on or off.
 - When the scale filter is on, the available notes (including repeats) are limited to the selected scale. The view mode keyboard will still display as chromatic style but only scale notes are available, unavailable note keys quantized up.
 - Scale filter affects view mode as well as other sequence functions.

6 Sequencing Patterns

6.13 Using the Fill Tool.

NOTES

Step sequencing and live recording provide manual functions for programming pattern sequences. The Fill Tool automates the population of steps in a track in an intelligent way. Fill is not just a workflow tool but offers creative and inspiring musical options for building arrangements and songs.

How does the Fill Tool work?

The Fill Tool is a sophisticated sequence editing utility which generates creative patterns. Samples configured in Play+ Sample Pack formats can be intelligently evaluated within the fill function. Note steps and sequences are created automatically when triggered by the Fill Tool and are based on:-

- Track and pattern areas selected.
- Parameter values and settings.
- Sample and Sample Pack configurations and structure.
- Whether MIDI or Audio mode is active.
- The type of fill algorithm applied.

What is the relationship with Sample Packs?

The sample pack format used is designed to integrate into Play+ and especially to be used by the Fill tool. This allows Fill to populate tracks with appropriate sounds. For example, Beat Fill algorithm will identify Kick, Snare and Hi-Hat samples based on the sample pack format and naming convention used. This is why sample packs and their incumbent samples must follow the defined format and named with the relevant characters.

- Character strings must follow the defined convention i.e. words kick, snare, hat included.
- The sample pack must be loaded to the sample pool.
- The upper most folder in the sample pool will be used by Fill if there are two folders with the same character string names. If an error stating 'Cannot find..' ie Kick, check that there isn't a duplicate empty folder higher in the sample pool, e.g. two kick folders.
- The microSD folders must follow the structure as defined for the specific OS release e.g. for version 1.4 the Melody Fill was added.
- Sample packs can only operate with one sub folder level.

Using Fill is an iterative and automated creative process. It can be initiated with the fill button and 'fills' can be generated several times to get a pattern that is suitable for your needs. Try different samples and algorithms and experimentation is recommended. This example refers to a sample track selection but a group of steps can also be selected to apply a Fill.

- 1 Load Sample Pack
Ensure the desired sample packs are loaded into the sample pool. Press (Screen) to access samples menu.

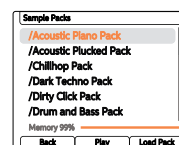

- 2 Select Tracks, or a selection of steps, to Edit
Press [Select] function pad for the tracks to select. Selected tracks illuminate light green and grid blue.

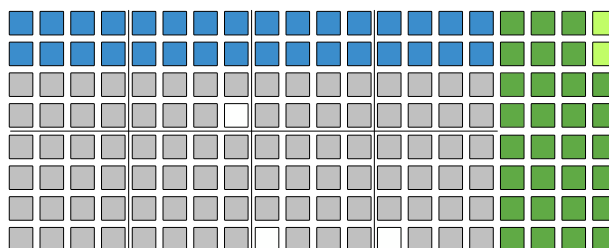

- 3 Select Fill Mode
Press [Fill] button to engage Fill mode. Each subsequent press of the Fill button will generate a pattern fill on the tracks or steps selected and based on chosen algorithm.



- 4 Select the Algorithm
Use the (Screen) knob to adjust the fill parameter in-focus. Use the left side [Screen] buttons to select the upper or lower parameter in-focus.

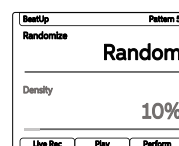

Fill Type sets the algorithm to apply when triggering a fill action. This is the upper parameter displayed. The lower parameter is the secondary parameter associated with the algorithm type. This will change depending on the algorithm selected.

- 5 Initiate a 'Fill'
Each press of the [Fill] button will trigger the application of fill based on the algorithm settings, sample pack / sample, synth, track / step. Some algorithms like beat fills have pre-defined patterns while random placement of steps is also possible.



- 6 Experiment and Iterate
Try experimenting with multiple triggers of the fill command. Try different algorithms and even mix algorithms across different tracks. Iterate adjustments and fills to create and revise patterns to find an acceptable position.



6 Sequencing Patterns

Random Fills

Random algorithm will populate the selected tracks with a series of randomly selected steps, density of which is defined between 10% and 100%. The current work step sample from the sample pool is used. The fill command will affect the step placement, sample will always be the current 'work step' sample. Select tracks or ranges to apply a fill.

CREATING PATTERNS FROM RANDOM FILLS

1. To maximise the features from the Fill function ensure the sample pool is populated as required. Sample packs are required to be loaded to the project sample pool to maximise some fill functions. Create a work step.
2. Select the track or multiple tracks to fill into by pressing the function pad [Select] for the respective tracks. Rows represent tracks. The Track will illuminate blue and the track select function button bright green. It is useful to fill populate multiple tracks initially, then edit each individually.
3. Press [Fill] button. Initial selection of fill will select the mode. When subsequently pressing the [Fill] button within the fill mode, a fill will be initiated to populate steps on selected tracks.
4. Select 'Random' Fill algorithm. Ensure the upper fill parameter is set to 'Random'. Press the upper left [Screen] button to ensure the algorithm type is in focus. Turn (Screen) when the upper parameter is highlighted to select the algorithm, in this example select 'Random'.
5. Set the 'Random' Fill algorithm density. Press the left side [Screen] button to ensure the algorithm density is in focus. Turn (Screen) when the lower parameter is highlighted to select the density %. This is the amount of steps to populate where 100% is all steps. Minimum is 10%. If multiple tracks are selected, the randomisation of steps applied will be different across each track.
6. Press [Fill] button again. The steps across the track will be populated with the a series of randomly selected steps with the current work step. The amount of steps populated will be based on the fill density.
7. Try Iterating further [Fill] commands to trial & error new patterns. This generates new step patterns.
8. Each track can then be edited individually. For example, the sample can be changed per track while retaining the fill generated pattern steps. Also why not try using the other Randomize or Chance parameters to add variation to the fill generated tracks.

Beat Fill including Kick, Snare & HiHat Fill

The Beat fill algorithm will populate selected tracks with a genre based pattern up to 16 steps in length and is based on one of the 128 pre-programmed, genre based rhythms. Samples are intelligently selected by the fill tool from the loaded sample pool folder. Step placement is fixed based on the current genre and uses notes from the applied fill template or can be set to a unique note from within the Settings > 'Fill Config' Menu. The fill tool is not linked to the actual project tempo but the Beat genres are designed for specific tempo ranges.

■ CREATING PATTERNS FROM BEAT FILLS

1. To maximise the features from the Beat Fill function ensure the sample pack required is loaded to the project sample pool. Beat fill is heavily reliant on correctly formatted sample packs.
2. Select the tracks to fill into by pressing the function pad [Select] for the respective tracks. Rows represent tracks. The Track will illuminate blue and the track select function button bright green. Ideally select tracks to cover Kick, Snare and Hats which Beat Fill is based around.
3. Press [Fill] button. Initial selection of fill will select the mode. When subsequently pressing the [Fill] button within the fill mode, a fill will be initiated to populate steps on selected tracks.
4. Select 'Beat' Fill algorithm. Ensure the upper fill parameter is set to 'Beat'. Press the left side [Screen] button to ensure the algorithm type is in focus. Turn (Screen) when the upper parameter is highlighted to select the algorithm, in this example select 'Beat'.
5. Set the 'Beat' Fill algorithm genre. Press the left [Screen] button to ensure the genre is in focus. Turn (Screen) when the lower parameter is highlighted to select the preset. This is a pre-programmed rhythm which will be applied for 1-3 tracks for Kick, Snare and Hi-Hats respectively.
6. Press [Fill] button again. The selected steps will be populated with the pattern based on genre preset and samples from the sample pool.
7. Try Iterating [Fill] further to trial & error new samples into the existing, fixed pattern. Each iteration will apply a new sample set. Try setting the folder parameter and randomizing an octave to create tonal sounds.

Note that a variation of beat fill exists to allow tracks to be managed individually. Select Kick, Snare or HiHat as the Type and select only one track to populate steps based on the genre and samples based on the type.

6 Sequencing Patterns

Chord Fills

Chord algorithm will populate 4 selected tracks over a pattern length up to 64 steps with melodic and chord progressions. It is important that the microSD card format is structured properly. The 'MelodyFills' folder will contain the source pattern templates for generating chords and melodies when using the fill algorithm. Also try experimenting with different scale and scale filter settings.

CREATING PATTERNS FROM CHORD FILLS.

1. To use the Chord Fill function ensure that the sample pool contains a synth folder i.e. a folder with the character string 'Synth' in the name. Some sample packs already have synth folders, so one can simply be loaded to the project sample pool. Chord fill is heavily reliant on correctly formatted sample packs and the samples in a synth folder.

Factory Sample Pack	Folder
80's Moms Pack	Synths
Drum and Bass Pack	Synth
Dubcore Drums	Synth
Dubstep Pack	Synth
Gangsta Rap Pack	Synth
House Pack	Synth
Trap Pack	Synth
Intellectual Pack	Synths
Slam Modeling Pack	VHS Synths
Tech House Pack	Synth
Juke-Footwork Pack	Synth

Synth Folder

If a synth folder does not exist in the sample pool, it can be created and named as such. Copy samples to this folder to use in the chord fill.

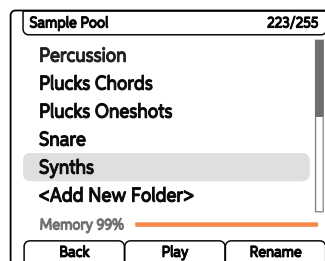

2. The length of the tracks can be up to 64 steps. Set a track length for all tracks to suit the pattern required.
3. Select the 4 track channels to fill into by pressing the [Select] function pad buttons for the respective tracks. Rows represent tracks. The Track will illuminate blue and the track select function button lit bright green. Selected tracks will cover each note in a generated chord.
4. Press [Fill] button. Initial selection of fill will select the mode. When subsequently pressing the [Fill] button within the fill mode, a fill will be initiated to populate steps on selected tracks.

5. Select 'Chords' Fill algorithm. Ensure the upper fill parameter is set to 'Chords'. Press the left side [Screen] button to ensure the algorithm type is in focus. Turn (Screen) when the upper parameter is highlighted to select the algorithm, in this example select 'Chords'.
6. Set the 'Chord' Fill genre. Press the left side [Screen] button to ensure the algorithm genre is in focus. Turn (Screen) when the lower parameter is highlighted to select the genre preset. This is a pre-programmed chord pattern from a factory selection of 48 patterns.
7. Press [Fill] button again. The selected steps will be populated with the pattern based on genre preset and samples from the sample pool.
8. The programmed note samples can be changed individually to another sample by manually selecting it.

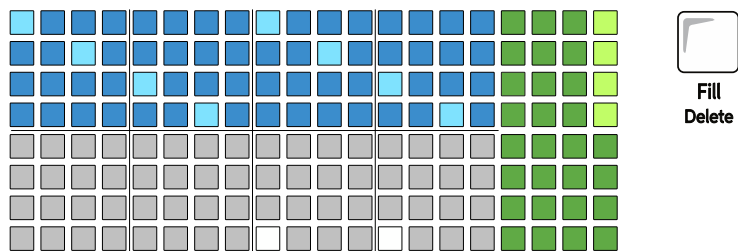

Chord and Bass fills use note values defined in the selected genre template. For Beat fills this note can be changed to a fixed note value from within the Settings > Fill Config options. This is accessed by pressing (Screen) button.

These settings also allow MIDI output channel assignment per instrument.

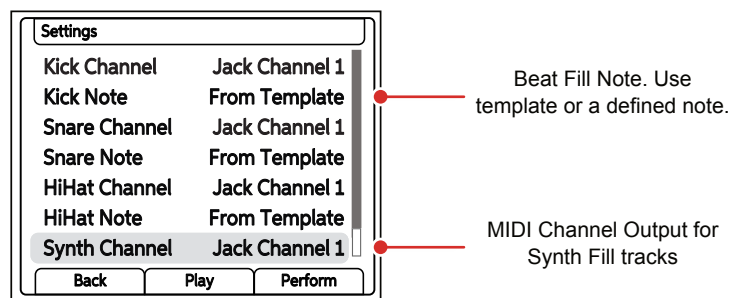

Defaults are 'From Template' for beat fill notes and 'Jack Channel 1' for MIDI Out.

6 Sequencing Patterns

Bass Fills

Bass algorithm will populate 1 selected track over a pattern length up to 64 steps with a melodic bass line. It is important that the microSD card format is structured properly. The 'MelodyFills' folder will contain the source pattern templates for generating bass lines when using the fill algorithm. Also try experimenting with different scale and scale filter settings.

■ CREATING PATTERNS FROM BASS FILLS.

1. To use the Bass Fill function ensure that the sample pool contains a bass folder i.e. a folder with the character string 'Bass' in the name. Some sample packs already have bass folders, so one can simply be loaded to the project sample pool. Bass fill is heavily reliant on correctly formatted sample packs and the samples in a bass folder.
 - All factory packs with the exception of intellectual and the slam modeling packs have a bass folder. A folder can be created and samples copied in if needed.
2. The length of the tracks can be up to 64 steps. Set a track length for all tracks to suit the pattern required.
3. Select a single track channel to fill into by pressing the [Select] function pad buttons for the respective track. Rows represent tracks. The Track will illuminate blue and the track select function button lit bright green.
4. Press [Fill] button. Initial selection of fill will select the mode. When subsequently pressing the [Fill] button within the fill mode, a fill will be initiated to populate steps on selected tracks.
5. Select 'Bass' Fill algorithm. Ensure the upper fill parameter is set to 'Bass'. Press the left side [Screen] button to ensure the algorithm type is in focus. Turn (Screen) when the upper parameter is highlighted to select the algorithm, in this example select 'Bass'.
6. Set the 'Bass' Fill genre. Press the left side [Screen] button to ensure the algorithm genre is in focus. Turn (Screen) when the lower parameter is highlighted to select the genre preset. This is a pre-programmed chord pattern from a factory selection of 48 patterns.
7. Press [Fill] button again. The selected steps will be populated with the pattern based on genre preset and samples from the sample pool.
8. The programmed note samples can be changed individually to another sample by manually selecting it.

Chord and Bass Fills

As well as creating chord fills and bass fills, both can be created together using the chord and bass fill option. Up to 64 steps can be used across 5 selected tracks to create a 4 polyphonic chord plus a single track bass line. The same pre-requisite set up also applied to this option including the microSD card 'MelodyFills' folder and the bass and synth sample pool folders with samples populated.

■ CREATING PATTERNS FROM BASS AND CHORD FILLS.

1. To use this Fill function ensure that the sample pool contains a bass and also a synth folder.
2. The length of the tracks can be up to 64 steps. Set a track length for all tracks to suit the pattern required.
3. Select 5 track channels to fill into by pressing the [Select] function pad buttons for the respective tracks. Rows represent tracks. The Track will illuminate blue and the track select function button lit bright green.
4. Press [Fill] button. Initial selection of fill will select the mode. When subsequently pressing the [Fill] button within the fill mode, a fill will be initiated to populate steps on selected tracks.
5. Select 'Chords and Bass' Fill algorithm. Ensure the upper fill parameter is set to 'Chords and Bass'. Press the left side [Screen] button to ensure the algorithm type is in focus. Turn (Screen) when the upper parameter is highlighted to select the algorithm.
6. Set the 'Chords and Bass' Fill genre. Press the left side [Screen] button to ensure the algorithm genre is in focus. Turn (Screen) when the lower parameter is highlighted to select the genre preset. This is a pre-programmed pattern from a factory selection of 48 patterns.
7. Press [Fill] button again. The selected steps will be populated with the pattern based on genre preset and samples from the sample pool.
8. The programmed note samples can be changed individually to another sample by manually selecting it.

6 Sequencing Patterns

Euclidean Fill

Euclidean fill algorithm will populate the selected tracks with a series of steps in a pattern from mathematically generated sequences. Euclidean patterns are generated based on a defined number of events, which aims to be equally spaced across the track length. The fill command will affect the step placement, the sample will typically be the 'work step' sample.

CREATING PATTERNS FROM EUCLIDEAN FILLS

1. To maximise the features from the Fill function ensure the sample pool is populated as required. Sample packs are required to be loaded to the project sample pool to maximise some fill functions. Create a work step.
2. Select the tracks to fill into by pressing the function pad [Select] for the respective tracks. Rows represent tracks. The Track will illuminate blue and the track select function button bright green. If multiple tracks are selected the patterns for each are identical.
3. Press [Fill] button. Initial selection of fill will select the mode. When subsequently pressing the [Fill] button within the fill mode, a fill will be initiated to populate steps on selected tracks.
4. Select 'Euclidean' Fill algorithm. Ensure the upper fill parameter is set to 'Euclidean'. Press the left side [Screen] button to ensure the algorithm type is in focus. Turn (Screen) when the upper parameter is highlighted to select the algorithm, in this example select 'Euclidean'.
5. Set the number of 'Euclidean' Fill algorithm events. Press the left side [Screen] button to ensure events is in focus. Turn (Screen) when the lower parameter is highlighted to select the number of events between 1-64. Event numbers higher than the total step count will fully populate the pattern 100%. The events aim to be equally spaced, where possible across the track step count.
6. Press [Fill] button again. The pattern will be created based on the current work step setting and number of events. Variations from the previous fill are only applied if different event settings are set prior to pressing [Fill].
7. Each track can then be edited individually. For example, the sample can be changed per track while retaining the fill generated pattern steps. Also why not try using the other Randomize or Chance parameters to add variation to the fill generated tracks.

Fill Algorithm Summary

Fill algorithms are at the heart of the creative process in generating patterns. Experimentation is encouraged and coupling fill generated patterns with other parameters such as chance. Fill can be a quick and easy way to get started in generating patterns followed by fine tuning and editing of patterns towards a final state.

Algorithm	Secondary Option	Description
Random	Density 10% - 100%	Randomly populates a number of steps governed by the density option across the selected track.
Euclidean	Events 1 - 64	Populates an equally spaced number of steps governed by the events option across the selected track.
Beat	Genre (various)	Populates steps based on one of 128 predefined genre based patterns. Operates on up to 3 Tracks. Uses a variety of Kick, Snare and HiHat samples from the sample pool sample pack.
Kick	Genre (various)	Operates similar to beat fill but only for the individual instrument i.e. kick on a single track.
Snare	Genre (various)	Operates similar to beat fill but only for the individual instrument i.e. snare on a single track.
HiHat	Genre (various)	Operates similar to beat fill but only for the individual instrument i.e. HiHat on a single track.
Chords	Genre (various)	Populates steps based on one of 48 predefined genre based patterns. Operates on 4 Tracks to create polyphonic chords and note patterns. Uses the 'Synth' folder samples.
Bass	Genre (various)	Populates steps based on one of 48 predefined genre based patterns. Operates on 1 Track to create a bass line. Uses the 'Bass' folder samples.
Chords and Bass	Genre (various)	Populates steps based on one of 48 predefined genre based patterns. Operates on 5 Tracks to create polyphonic chords and a bass line. Uses the 'Bass' and 'Synth' folder samples.

6 Sequencing Patterns

Beat Fill Algorithms

A total of 128 beat fill algorithms exist and are located in the 'BeatFill' microSD folder. These patterns are templates for creating the beat pattern.

Beat Fill Genre	Variants	Beat Fill Genre	Beat Fill Genre	Beat Fill Genre
Acoustic	1 - 15	x Backtrack	x Intelektual	x Robot Drum
Breakbeat	1 - 8	x Bicycle Fail	x Jump Up	x Sewers
Drum and Bass	1 - 16	x Break It	x Jumpy	x Slow Down
Dub	1 - 4	x Cat Hat	x Kick It	x Snaresky
Electro	1 - 8	x Crocko	x Look Up	x Spaciality
Exotic	1 - 9	x Destroyson	x Market Beat	x Spill That
Garage	1 - 8	x Driller	x Melty	x Step Up
HipHop	1 - 10	x Drowner	x Metal Hits	x Swing It
House	1 - 16	x Dubzap	x Mind Glowing	x Swoosh
IDM	1 - 16	x Fade In	x Nice Break	x Take It
Latin	1 - 4	x Fast Walker	x Oh Wait	x Think
Techno	1 - 8	x Fill It	x Pattern Break	x Tin
Trap	1 - 6	x Half Life	x Pitcher	x Too Basic
x All Different		x Hat Trick	x Playing Funny	x Two People
x Always Late		x Hi-Hat Uzi	x Rewind	x Way Too Late
x Autumn Fall		x Hitman	x Ridge Racer	

Chord & Bass Fill Algorithms

A total of 48 melody fill algorithms exist in the 'MelodyFill' microSD card folder. These are the templates for creating the bass and chord patterns.

Melody Fill Genre	Melody Fill Genre	Melody Fill Genre	Melody Fill Genre
Adventurer 1	Horizons 1	Nostalgia 1	Seashore 1
Adventurer 2	Horizons 2	Nostalgia 2	Seashore 2
Adventurer 3	Horizons 3	Nostalgia 3	Seashore 3
Ballandar 1	Jumpy 1	Pathfinder 1	Spaceship 1
Ballandar 2	Jumpy 2	Pathfinder 2	Spaceship 2
Ballandar 3	Jumpy 3	Pathfinder 3	Spaceship 3
Distance 1	Mystery 1	Riddle 1	Spiral 1
Distance 2	Mystery 2	Riddle 2	Spiral 2
Distance 3	Mystery 3	Riddle 3	Spiral 3
Happy Hour 1	New Quest 1	Sad Robot 1	Uprising 1
Happy Hour 2	New Quest 2	Sad Robot 2	Uprising 2
Happy Hour 3	New Quest 3	Sad Robot 3	Uprising 3

6.14 Creating Custom Fill Patterns.

Many of the fill functions use algorithms which use a pattern template as the reference. For example the 'beat' and 'chord and bass' fills all draw from the templates in the BeatFills and MelodyFills folders respectively. These are essentially patterns. It is therefore possible for user patterns to be created and to use as custom fill templates.

Important considerations for creating beat fill and melody fill templates

The instructions provided for creating fill templates must be followed exactly and in the correct sequence in order for the pattern to operate as a functional fill template when used in Play+.

	Beat Fill	Melody Fill	Description
Instruments	Kick, Snare, HiHat	Synth, Bass	Beats, synths and bass instruments for the template
Steps	16	64	Maximum number of steps in the pattern template
Tracks	3	4	Number of track channels. Beat needs 1 per instrument. Chord needs 4 and Bass 1.
Steps	16	64	Maximum number of steps in the pattern template
Location	BeatFills	MelodyFills	microSD card location folder
Track 1	Kick	Synth Note	Based on creating a beat or melody template
Track 2	Snare	Synth Note	Based on creating a beat or melody template
Track 3	HiHat	Synth Note	Based on creating a beat or melody template
Track 4	-	Synth Note	Melody template
Track 5	-	Bass	Melody template

6 Sequencing Patterns

The basic process for creating beat fill or melody fill templates is a strict process and steps must be adhered to in the correct order.

- 1** Create a New Project
Create a new blank project. This is used to create the pattern template based on set criteria and can be saved to be reused as the base for future templates.

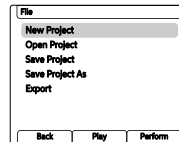

- 2** Load Sample Folders.
These sample folders must be loaded in a specific order. The instrument is determined specifically by the order in which it is loaded and not by its name.

- 1. Load First: Bass
- 2. Load Second: Kick
- 3. Load Third: HiHat
- 4. Load Fourth: Snare
- 5. Load Fifth: Any Other Pack
- 6. Load Sixth: Any Other Pack
- 7. Load Seventh: Synth

- 3** Add at least one sample
Load at least 1 sample per category. Samples can be created offline from Play+ i.e. on a PC or Mac and assembled into the instrument folders on the microSD card.

- 3** Build Patterns
Build the patterns precisely as per the defined track structure with loaded samples.

Beat Fills Audio / MIDI Channel

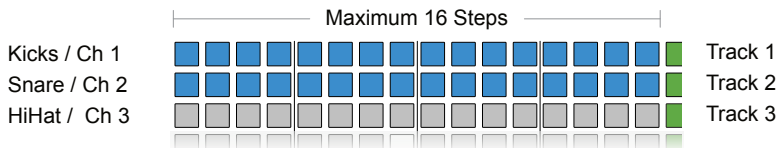

Melody Fills Audio / MIDI Channel

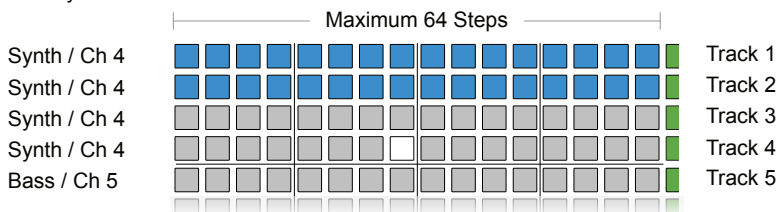

Must adhere to this instrument track order

- 4** Save Project
Save the project using 'Save' or 'Save As' in the file menu.

- 5** Relocate the Templates
Move and name the created patterns to the 'BeatFill' folder or to the 'MelodyFill' folder.

This should be done offline using a Mac or PC with the microSD card.

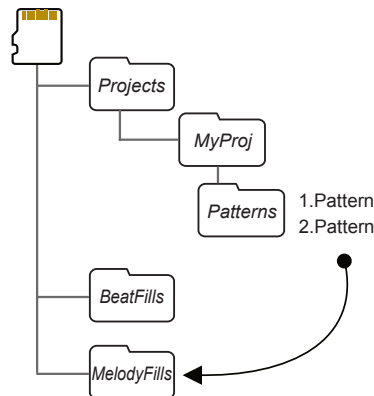

CREATING A BLANK CUSTOM FILL TEMPLATE

Creating a project as a blank template in the proper fill structure can speed up workflow when creating custom beat, melody, chord or MIDI templates. Folders must contain at least 1 sample in the relevant category.

1. Press (Screen) to select the menu. Turn (Screen) to navigate to highlight 'File' in the menu. Press (Screen) to select.
2. Turn (Screen) to highlight 'New Project'. Press (Screen) to select the highlighted 'New Project' option.
3. A prompt to save the current project may be presented. Select 'Yes' or 'No'. A new project will be created with the default settings.
4. Once a new empty project has been created, load the sample folders. This must be performed precisely in the defined order. The order of loading defines the actual instrument and not the folder name.
5. Press (Screen) to select the menu. Turn (Screen) to navigate to highlight 'Samples' in the menu. Press (Screen) to select.
6. Turn (Screen) to highlight 'Load Files or Folders'. Press (Screen) to select this option.
7. Navigate to the folder to load. Samples can be created and stored in the appropriately named folder externally. Press [*Load Folder*] screen button on the selected folder. The loading of folders MUST be performed in this order:-
 1. Bass. Load the folder named 'Bass' containing bass samples.
 2. Kick. Load the folder named 'Kick' containing kick samples.
 3. HiHat. Load the folder named 'HiHat' containing hat samples.
 4. Snare. Load the folder named 'Snare' containing snare samples.
 5. Any other synth. Load a folder containing synth samples.
 6. Any other synth. Load a folder containing synth samples.
 7. Synth. Load the folder named 'Synth' containing synth samples.
8. Save the project. Press (Screen) to select the menu. Turn (Screen) to navigate to highlight 'File' in the menu. Press (Screen) to select.
9. Turn (Screen) to highlight 'Save Project As'. Press (Screen) to select then press [*Save*] screen button. Enter a relevant name i.e. 'Fill Empty Template' and press [*Save*].

6 Sequencing Patterns

The process of creating a beat fill custom templates is a precise process. The steps must be followed exactly as stated otherwise a fill command when executed may fail.

CREATING A BEAT FILL PATTERN TEMPLATE

1. Create a new blank fill project or ideally load a previously created and pre-configured fill template.
2. This will have been created with the Beat Fill; Kick, HiHat and Snare folders loaded in the correct order and at least 1 sample contained in each folder.
3. Create 'Beat' patterns which use the 3 beat fill three instruments loaded. It is important to strictly use:-
 - Track 1 for Kicks. Samples used from the 'Kick' folder
 - Track 2 for Snares. Samples from the 'Snare' folder.
 - Track 3 for Hi Hats. Samples from the 'HiHat' folder.
4. Note that other params for example cutoff etc, it will work in Fill node when using audio tracks. A fill command fill will trim a track length from its current state up to 64 steps to the destination track length, if the source template is shorter, it will be duplicated to fit longer track.
5. If MIDI tracks are required the audio pattern tracks can be copied over like for like and MIDI channels assigned. Some elements such as chance and repeat are removed when copying but can be entered in the MIDI tracks directly.
 - Copy Audio Track 1 Kick to MIDI Track 1. Set to MIDI Channel 1. Select audio tracks, press [Copy]. Select MIDI mode and its equivalent tracks and Hold [Shift] + press [Paste]. Set each of the four tracks to MIDI Channel 4.
 - Copy Audio Track 2 Snares to MIDI Track 2. Set to MIDI Channel 2.
 - Copy Audio Track 3 Hi Hats to MIDI Track 3. Set to MIDI Channel 3.
 - To Set MIDI Channel. To Set MIDI Channel, firstly select MIDI Mode, select the track then use the (Sample) knob to adjust the Channel.

6. Save the project.
 - Press (Screen) to select the menu. Turn (Screen) to navigate to highlight 'File' in the menu. Press (Screen) to select.
 - Turn (Screen) to highlight 'Save Project As'. Be careful not to overwrite the original base template by using 'Save'. Press (Screen) to select then press [Save] screen button.
7. The patterns are saved in the microSD, Projects / MyProj / Patterns folder. Use an external PC or Mac to copy the created pattern to the 'BeatFill' folder for use with fill. Do not change the project structure.

The process of creating a melody fill custom templates is a precise process. The steps must be followed exactly as stated otherwise a fill command when executed may fail.

■ CREATING A MELODY FILL PATTERN TEMPLATE

1. Create a new blank fill project or ideally load a previously created and pre-configured fill template.
2. This will have been created with the Melody and Chord Fill; Synths and Bass folders loaded in the correct order and at least 1 sample contained in each folder.
3. Create 'chord', 'bass' or 'chord and bass' pattern using the 3 melody / chord fill instruments loaded. It is important to strictly use the following for chords and bass:-
 - Track 1-4 for any synth. Samples used from the 'Synth' folder or any of the other synth folders. These can represent chord notes.
 - Track 5 for Bass. Samples from the 'Bass' folder.
4. Note that other params for example cutoff etc, it will work in Fill node when using audio tracks. A fill command fill will trim a track length from its current state up to 64 steps to the destination track length, if the source template is shorter, it will be duplicated to fit longer track.

6 Sequencing Patterns

5. If MIDI tracks are required the audio pattern tracks can be copied over like for like and MIDI channels assigned. Some elements such as chance and repeat are removed when copying but can be entered in the MIDI tracks directly.
 - Copy Audio Tracks 1, 2, 3 and 4 Synths to MIDI Tracks 1-4 respectively. Set each of the four tracks to MIDI Channel 4. Select audio tracks, press [Copy]. Select MIDI mode and its equivalent tracks and Hold [Shift] + press [Paste].
 - Copy Audio Track 5 Bass to MIDI Track 5. Set to MIDI Channel 5.
 - To Set MIDI Channel, firstly select MIDI Mode, select the track then use the (Sample) knob to adjust the Channel.
6. Save the project.
 - Press (Screen) to select the menu. Turn (Screen) to navigate to highlight 'File' in the menu. Press (Screen) to select.
 - Turn (Screen) to highlight 'Save Project As'. Be careful not to overwrite the original base template by using 'Save'. Press (Screen) to select then press [Save] screen button.
7. The patterns are saved in the microSD card, Projects / MyProj / Patterns folder. Use an external PC or Mac to copy the created pattern to the 'BeatFill' folder for use with fill. Do not change the project structure.

NOTES

The final stage of creating custom fill templates requires the physical copying of the created pattern to the fill template folder. The file copying process will require a PC or Mac to edit the microSD card. It is important to keep the original project structure intact so only copy, not cut the patterns.

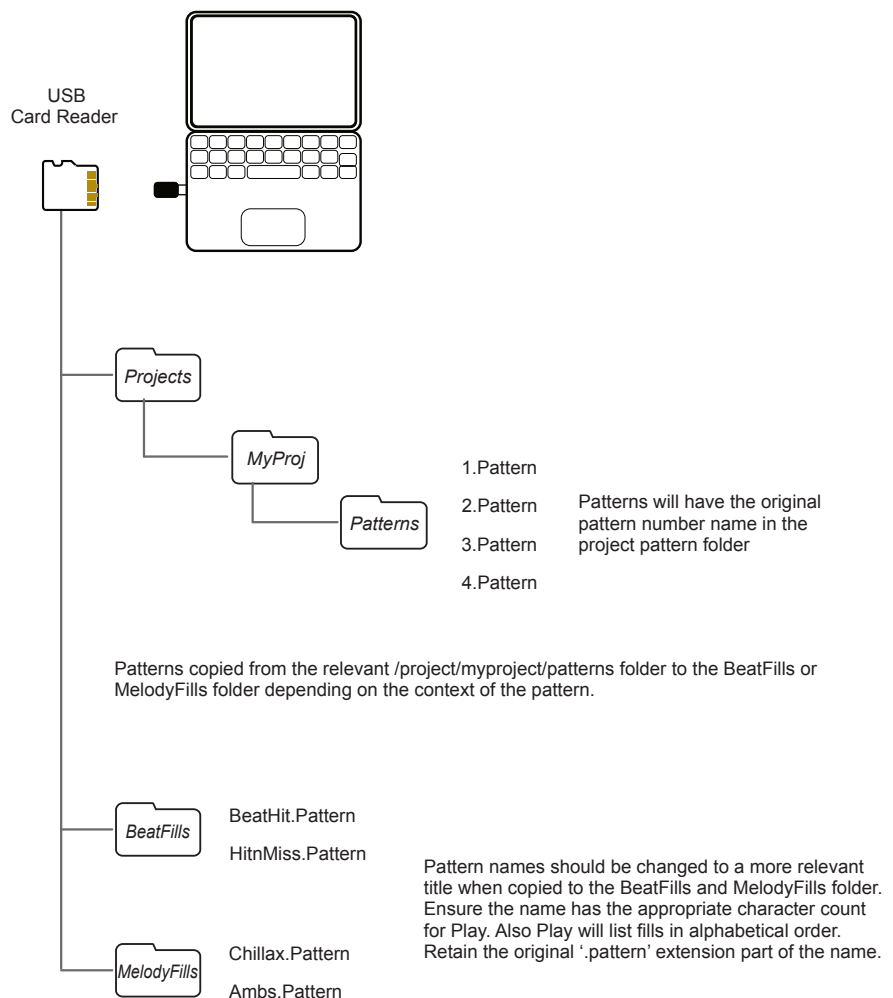

7

Arrangements & Variations

Patterns can be played individually using [Play] but can also be chained to play in a sequence using [Shift] + [Play]. Chaining patterns can create longer arrangements in a sort of song mode. Building either full arrangements or creating sections is possible in Pattern view. Building patterns is performed in Sequence view. Play+ also has a specific feature called 'Variations'. Variations allow alternative versions of tracks to be created and used to help build arrangements or just to use in a performance or live improvisations. While these structural elements are key to building full songs and chaining patterns, other techniques can also contribute to building arrangements. Adjusting some of the parameter settings and automating parameters across steps and patterns contributes to the variation and interest built into the creative process. In addition some parameters can help create evolving and

continuously changing patterns. Chance and Randomize are two such parameters. Patterns can appear to operate on their own evolving journey, where defined steps will appear to play an unlimited level of variation. Considering these structural and creative elements in isolation is a good starting point and helps get to know these features better. Combining these elements and experimenting with combinations adds even more power and expands the creative possibilities further. There are no rules when it comes to Play+ sound design, the limitations often only come from the imagination of the user. Trial and error, experimentation and just tweaking may bring surprisingly musical results.

7 Arrangements & Variations

7.1 Pattern Mode.

NOTES

Pattern mode is used to manage the pattern selection including chaining and playing selected pattern sequences. Pattern mode offers control over the entire set of 128 patterns, where each of the 8 x 16 grid buttons represent an individual pattern in a project. The [Patterns] button toggles between Pattern mode and the default Sequencing mode.

Press [Patterns] to access the Pattern Mode.

Press [Shift] + [Play] to play a pattern sequence

Playback of a pattern sequence will start on the selected pattern, play through adjacent patterns until no more patterns are in the sequence and then restart from the first pattern in the sequence.

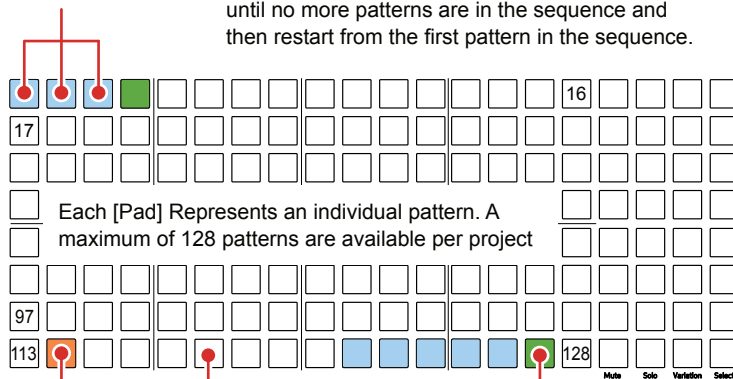

Each [Pad] Represents an individual pattern. A maximum of 128 patterns are available per project



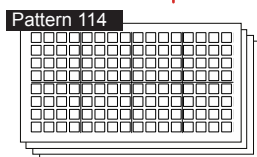

Tap [Pad] to select or create a new pattern

Leave a blank pad to signal end of a chain



Press [Play] to play and loop the current pattern

Pattern Mode - 8x16 Grid Pad Colors

-  Orange. Currently active / loaded pattern.
-  Dim Green. Empty Pattern.
-  Blue. Available Patterns.
-  Flash Orange / Blue. Pattern pending to play next when manually triggered.

7.2 Managing Patterns.

Patterns can be selected from a total of 128 pattern slots. Patterns can be created and edited individually or copied and pasted and then further editing performed.

SELECTING / CREATING A PATTERN

1. Press [Patterns] from sequencer mode to select pattern mode. If in pattern mode, pressing [Patterns] will toggle to sequencer mode.
2. Press [Pad] to select an existing pattern to edit or play or to create a new pattern from an empty slot. Pads represent patterns and are laid out across the 8 x 16 grid with a total of 128 pattern slots available. The selected pad is lit Orange.
3. The selected pattern can now be played or edited in sequencing mode, selected by pressing [Patterns] from pattern mode.

COPYING A PATTERN

1. Press [Patterns] from sequencer mode to select pattern mode. If in pattern mode, pressing [Patterns] will toggle to sequencer mode.
2. Hold [Pad] for the source pattern to copy from. Only one pattern can be copied at once.
3. While still holding the source pad, Press [Pad] for the destination slot to copy into.

DELETING PATTERNS

1. Press [Patterns] from sequencer mode to select pattern mode. If in pattern mode, pressing [Patterns] will toggle to sequencer mode.
2. Hold [Pad] for the target patterns to delete. Multiple pads / patterns can be selected.
3. While still holding the target pads, Press [Shift] + [Delete]. The delete command is the secondary function on the Fill button.

Quick Copy: Note that quick copy can operate for steps, step pages, Patterns and Variations. Quick copy is performed by keep holding the source [Pad] for about half a second + Press [Pad] for any destination pads. Pads will flash blue twice when copied to the clipboard and when pasted.

7 Arrangements & Variations

7.3 Playing & Chaining Patterns.

NOTES

Patterns can be played individually or chained to play in sequence as a complete set or as a selected series of patterns. The play functions are applied in any mode, but chaining patterns is performed in the pattern mode view. It is useful to create chained sections and then to manually change playback between them for live improvisation.

Press [Patterns] to access the Pattern Mode.

Press [Play]

Press [Play] to play and loop only the current pattern. Press [Play] again to stop playback.

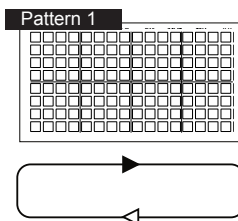

1 2 3 4 5 A chained sequence plays until an empty pad is reached and then loops playback from start.

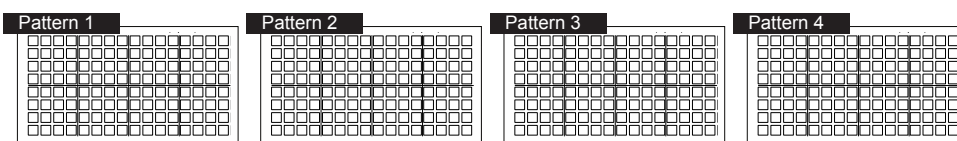
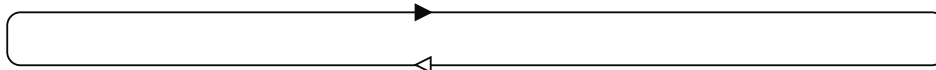

Press [Shift] + [Play]

Press [Shift] + [Play] to play and loop all the chained patterns in sequence until an empty pad is reached. Press [Play] to stop playback.

When a sequence is playing, other sequences or patterns can be manually triggered by pressing the [Pad]. This will switch between patterns on the fly. Patterns cued to play next will flash its pad orange and light blue.

Cue a pattern to play after the completion of the current pattern: Press [Pad] for next pattern.

Immediately switch playback to another pattern: Press [Shift] + [Pad] for next pattern.

PLAYING A SINGLE PATTERN

1. Press [Play] from any mode.
2. The current pattern, which is indicated in pattern mode with a pad lit Orange, will play. The pattern will loop playback continuously.
3. Press [Play] to stop playback. The playhead is reset to the pattern start.

CHAINING A SERIES OF PATTERNS

1. Patterns are chained in pattern mode. Sometimes chaining of patterns is called Song mode. Press [Patterns] to toggle to pattern mode.
2. Patterns should be created in sequence horizontally across the grid. This will require patterns to be created from new or copy / pasted in sequential order. The order runs in grid order i.e. left to right - top to bottom, starting top left corner of the 8x16 grid.
3. Ensure an empty pattern slot pad is placed at the end of the chain. A sequence will recognise the loop point once the empty pad is reached.

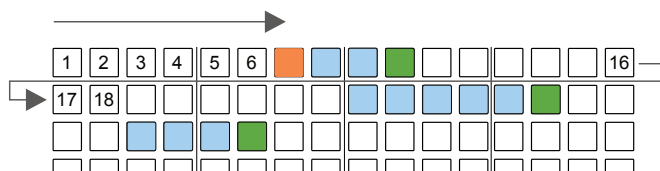

PLAYING A CHAINED SERIES OF PATTERNS

1. Press [Shift] + [Play] in any mode.
2. Patterns will play, starting with the currently selected pattern. Once each pattern completes playback, the next available pattern in the sequence will play. The sequence of patterns will play until an empty pad is reached at which point the chain will restart and loop playback.
3. To switch to another pattern / chain during playback, Press [Pad]. The next pattern will be cued and will play once the existing pattern completes playback.
4. To immediately switch to another pattern / chain during playback, Press [Shift] + [Pad]. The next pattern will instantly start to play.
5. Press [Play] to stop and reset playback.

7 Arrangements & Variations

7.4 Track Variations.

NOTES

While patterns in themselves cover all 8 tracks, it is also possible to create and store variations of each track. This is useful in creating arrangements but also a great performance tool. Up to 16 variation slots are available for each track.

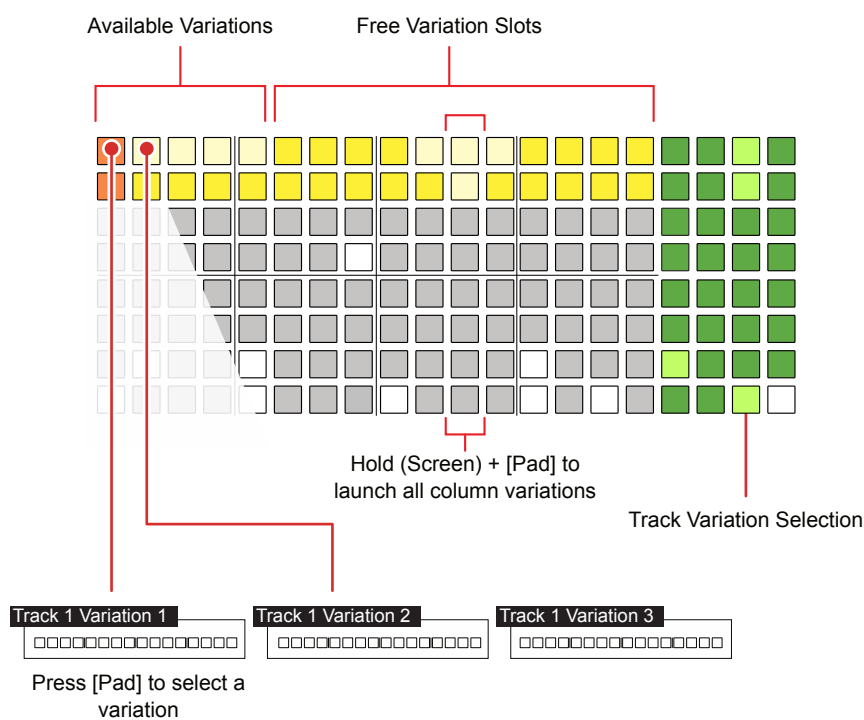

A variation is an alternative version of a track that can be created and then selected manually either to change an arrangement or used to add variety during on-the-fly and live performances.

Press [Variation] pad for the desired track row to access one of 16 variations.



Variations operate at track level. They can be selected manually but it is not possible to automatically select or chain track variations together.

Variation Mode - 8x16 Grid Pad Colors

-  Orange. Currently active / loaded track variation.
-  Yellow. Empty Variation Slot.
-  Bright Yellow. Available Variations.

7.5 Creating / Deleting Variations.

Variations of tracks can be created and stored in up to 16 variation slots, represented by the grid pads in variation mode. Typically the main track can be duplicated before adjusting the steps and parameters to create a variation.

■ CREATING A SERIES OF TRACK VARIATIONS

1. Create a main pattern. This will typically be stored in column 1 of the variation slots.
2. Press the [Variation] pad located on column 19 for the respective track to select variation mode for the track. The function variation pad, will be lit bright green and the variation slots 1-16 for the track will be lit yellow.
3. The typical workflow is to copy the main pattern to another slot before editing. This can continue with other variations. Alternatively a new slot can be selected and a pattern created as new.
4. To quick copy a variation; Hold [Pad] for the source variation to copy from. Only one variation can be copied at once. An existing, filled variation will be lit bright yellow.
5. While still holding the source pad, Press [Pad] for the destination slot to copy into. A blank variation slot will be lit dimmed yellow.
6. Press [Pad] to select a variation to edit. Steps and parameters can be adjusted. The pad is lit Orange for the currently selected variation.

■ DELETING VARIATIONS

1. Press the [Variation] pad located on column 19 for the respective track to select variation mode.
2. Hold [Pad] for the target variation slot to delete. Multiple pads / patterns can be selected. An existing, filled variation will be lit bright yellow.
3. While still holding the target pads, Press [Shift] + [Delete]. The delete command is the secondary function on the Fill button. The variation is deleted and now empty variation pads revert to being lit dimmed yellow.

Quick Copy: Note that quick copy can operate for steps, step pages, Patterns and Variations. Quick copy is performed by keep holding the source [Pad] for about half a second + Press [Pad] for any destination pads. Pads will flash blue twice when copied to the clipboard and when pasted.

7 Arrangements & Variations

There is a main menu settings option that affects the way that the variation page is presented. By default, selecting a [Variation] button for a track will only present the selected track's 1-16 variation slots. The option to display and select all tracks when pressing any [Variation] pad is also possible.

CHANGING VARIATION PAGE BEHAVIOUR

1. Press (Screen) to select the main menu.
2. Turn (Screen) to scroll and highlight the sub menu options. Highlight 'Settings'. Press (Screen) to select this sub menu.
3. Turn (Screen) to scroll and highlight the options. Highlight 'Variation Page'. Press (Screen) to select this option.
4. Turn (Screen) to scroll and highlight the options. Highlight either 'Separate Tracks' or 'All Tracks'. Press (Screen) to select the highlighted option.
5. Press the [Variation] pad located on column 19 for the respective track to select variation mode for the track. The variation pad will be lit bright green and the variation slots 1-16 for the track will be lit yellow.
 - Separate Tracks. This is the default setting and will only display the page for the selected tracks. Track selection is made by using the [Variation] pad row for each track to select.
 - All Tracks. When selecting any [Variation] pad for any track, the variation page will show the entire set of tracks. All tracks will also be automatically selected. Press any [Variation] pad row to select all or no tracks.
6. Press [Back] screen button several times to exit the menus.

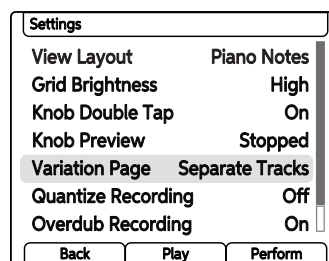

7.6 Playing Variations.

Variations of tracks can be played manually. It is not possible to chain or automate playback of variations.

■ SELECTING & PLAYING VARIATIONS

1. Ensure a series of track variations have been created. These will be lit bright yellow as opposed to empty slots which are dimmed yellow.
2. Press the [Variation] pad located on column 19 for the respective track to select variation mode for the track. The variation pad will be lit bright green and the variation slots 1-16 for the track will be lit yellow.
3. If playback is stopped, Press [Pad] for the track row variation slot to select. This is the track variation to play when selecting [*Play*].
4. If the pattern is already playing;
 - Press [Pad] for the track row variation slot to select from the 8x16 grid. This is the track variation to play next and will switch to play the new variation upon completion of the currently playing pattern.
 - Press [Shift] + [Pad] for the track row variation slot in the 8x16 grid to select and play immediately. To be precise, the switch will be triggered on the next step.
5. To launch an entire set of available variations in a vertical column across all tracks, Hold (Screen) + Press [Pad] for any track. Any variations that exist within the same column, across all tracks in the 8x16 grid will be launched / selected to play.
6. Variations can be selected on the function buttons when in perform or pattern mode.

7 Arrangements & Variations

7.7 Organic & Generative Arrangements.

NOTES

Play+ has many features to add interest and create variations within patterns and arrangements. Some parameters can add more generative style variations where patterns and arrangements develop with an evolving and dynamic nature others can provide a fixed change.

Considerations and tips in developing arrangements and variations

- Many features introduce a fixed change which can be applied and changed across patterns. For example repeats and effects. These can however be automated to create variation.
- Some parameters can add more generative style variations where patterns and arrangements develop with an evolving and dynamic nature. Chance and Randomize are examples.
- Chance can help build arrangements. Creating variations with these parameters can give the impression of a longer, evolving arrangement even when looping a single pattern.
- Randomize can add variation and operate as a continuous evolving pattern. Randomize operates differently to other parameters and needs to have a step selected, i.e. hold the step pad or select a track and also the Randomize page needs to be in view. The Randomization can be printed and saved to the track using [Save].
- Chained patterns can build longer arrangements. Chance, Action Play/Skip operate differently when patterns are chained.
- Modulation by turning parameter knobs can manually add variations. This is possible even in pattern mode by selecting the track to adjust.
- Applying several iteration of 'fill' will allow pattern variations to be created. Try changing one or two tracks with fill in a series of duplicated patterns or variations.
- Muting and soloing tracks can also form part of creative variation application.
- Combining Play+ feature set, for example chance, randomisation, variations etc together can build continuously changing landscapes and arrangements.
- Undo / Redo commands can be used to backtrack when tweaking and improvising performances. Hold [Shift] to see if a Undo/Redo command is available.

7.8 Chance.

Chance offers a level of probability to determine if or when a selected action is executed. The Chance parameter establishes the criteria in which the event is executed or not and the Action, secondary parameter, will set what specific action is affected by chance.

Primary Parameter

Parameter	Setting	Description
Chance	Always	Default setting. Probability is off meaning the action will always be initiated.
Chance	10% - 90%	The probability percentage that an action will occur. The higher the %, the more chance the action will occur.
Chance	The Group With Last	Plays the step only if the previous step with the condition on the track was played. Steps can be linked with an all or none random probability.
Chance	Play N / Skip M	Plays a step on each of N Loops before skipping the step for M Number of loop cycles.
Chance	Skip N / Play M	Skips a step on each of N Loops before playing the step for M Number of loop cycles.
Chance	Genre (various)	Operates similar to beat fill but only for the individual instrument i.e. HiHat on a single track.

Secondary Parameter

Parameter	Setting	Description
Action	Play Step	Default setting. Probability is off meaning the action will always be initiated.
Action	Random X	Will randomize a selected parameter 'X'. Options are Sample, Note, Octave Up, Microtune, Cutoff, Repeat, Sample Start, Sample End.
Action	Rnd Cutoff CC	Available only when in MIDI / Synth mode and when a synth is selected. This will apply chance to the macro set for 'Filter Cutoff'
Action	Humanize	Randomises the micromove parameter of the step to add an organic shuffle.

The availability of options will depend on whether operating in Audio or MIDI/Synth mode and the type of step selected.

7 Arrangements & Variations

Chance Examples



Chance 10% - 90%.

X% Performs an action based on chance. Chance applies a % probability of it playing that can be set to 10%, 20%, 30%, 40%, 50%, 60%, 70%, 80% or 90%

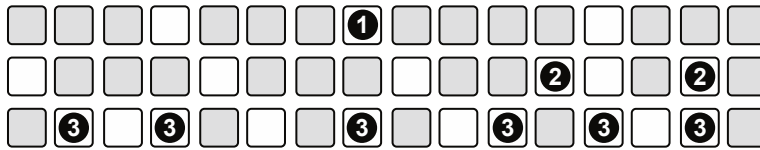

- 1** Chance '60%' - Action 'Play Step'
The step note / event will play but only with a 60% probability level. Other steps will always play each cycle.
- 2** Chance '20%' - Action 'Rnd Sample'
The step note / event will play with a 20% probability that a new random sample is used for the step note. Used to add interest and variation across several parameters.
- 3** Chance '80%' - Action 'Humanize'
The step note / event will play with a 80% probability that a random micromove adjustment is used for the step note. Used for several notes to add a shuffle.

Group With Last.

Plays the step with the chance only if the previous step with the condition on the track was played. Steps can be linked with an all or none random probability.

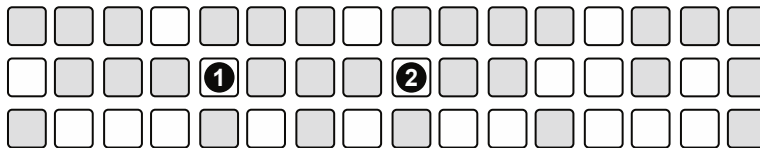

- 1** Chance '60%' - Action 'Play Step'
This step is the prerequisite for the following step where the 'Group With Last' is located. The chance function on the following step will only be applied if this step is activated. If it does not trigger then the following step chance will not be applied although the step can still be played.
- 2** Chance 'Group With Last' - Action 'Rnd Sample'
The step note / event will be played and applied with a random sample only if the prior step is triggered. If the previous step is not triggered then this step will play as normal i.e. chance action not applied.

Play N / Skip M.

N is the number of pattern loop cycles to play the step. M is the number of pattern loop play cycles to ignore the playing of the step. This is based typically on single patterns which will loop playback. On chained patterns the cycle on the pattern playback operates as if its the first loop.

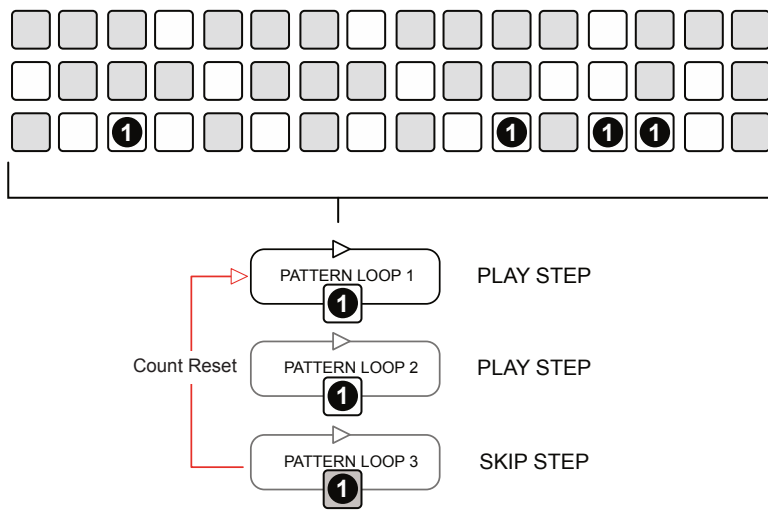

- 1
Chance 'Play 2 / Skip 1' - Action 'Play Step'
 Steps will be played on the N loop cycles, in this example 2. The steps are played on loop cycle 1 i.e. first 16 steps and also loop cycle 2, next loop of 16 steps. On M, the third loop cycle, steps will be skipped and not played. The sequence is then reset.

Skip N / Play M

The Skip N / Play M operates very similar to the Play N / Skip M. It starts with skipping rather than playing steps in the loop cycles therefore is in reverse of Play N / Skip M but follows the same principles of operation.

7 Arrangements & Variations

7.9 Randomize.

NOTES

Randomize sets the strength, in % of a parameter application by range. It is important to note that this range is not a range of steps but is the range of the applied parameter value. A random value is applied within a range that can add variation and even transform entire arrangements and patterns.

Randomize operates differently to the conventions of most other parameters. It is not normally set as a 'work step' but is applied when a step or track is selected for editing and is applied as a global setting. Randomize is not applied to individual steps. Randomization, unless manually saved is applied on a temporary basis.

Two important, unique and pre-requisite conditions must be considered when using Randomize for it to operate;

- The Randomize page must be in focus / displayed. Exiting the Randomize page will deactivate the randomize feature.
- A Step must be selected i.e. pad held / track selected where the Randomization will be applied.

The randomization can then be printed / saved to a track using [Save]. The randomization is then retained when switching to other parameters.

To reset the randomisation and write a new set of random values, use [Shift] + [Save]. The new, temporary randomization values can also be saved if required.

The value is set using the Randomize Type secondary parameter and the range on the primary Randomize knob. The available secondary options will be dependant on the Audio Sample or MIDI / Synth mode selected.

Primary Parameter

Parameter	Setting	Description
Randomize	0% - 100%	Range for random value application. A parameter value is applied within this range.

Secondary Parameter

Parameter	Setting	Description
Randomize Type	Sample In Folder	Will select a random sample from the currently selected folder.
Randomize Type	Sample In Pool	Will select a random sample from the entire sample pool.
Randomize Type	Sample Length	Will adjust the length by randomising sample start and sample end
Randomize Type	Texture	Patch of parameters consisting of Filter Cutoff, Resonance and Overdrive.
Randomize Type	1 Octave	Plays notes within 1 Octave.
Randomize Type	2 Octaves	Plays notes within 2 Octaves.
Randomize Type	Volume	Adjusts Volume level.
Randomize Type	Space	Patch of parameters consisting of Panning, Delay Send, Reverb Send
Randomize Type	Nuke	Patch of parameters consisting of Samples in Folder, Filter Cutoff, Resonance, Overdrive and Panning.
Randomize Type	Duke Nuke	Patch of parameters consisting of Samples in Pool, Filter Cutoff, Resonance, Overdrive and Panning.
Randomize Type	Filter CC/Macro	Available only when MIDI/Synth mode and a synth is selected. Will allow randomization to be applied to the macro assigned to 'Filter Cutoff'

The availability of options will depend on whether operating in Audio or MIDI/Synth mode and the type of step selected.

7 Arrangements & Variations

■ GENERATING RANDOMIZATION FOR STEPS OR A TRACK

1. When applying a Randomize, start by selecting steps;
 - Select a track for a block of steps.
 - Hold a [Pad] for a step on a track. Keep the pad held.
2. Touch (Randomize) to toggle the randomize or randomize type options. Ensure the upper 'Randomize' option is in focus. The left side screen buttons also can toggle between the options.
3. Turn (Randomize) or Turn (Screen) knob to set a percentage between 0% - 100%. A setting of 0% means no randomization and 100% will cover the entire range of options from the Randomize Type values.
 - The % represents the range of values from which to randomize, and does not represent the number of steps affected.
 - The value is applied globally, not individually per step.
 - The value will be reset to 0% if the 'Randomize' display view is exited, i.e. when selecting another sample based parameter.
4. Touch (Randomize) to toggle the randomize or randomize type options. Ensure the lower 'Randomize Type' option is in focus. The left side screen buttons also can toggle between the options.
5. Turn (Randomize) or Turn (Screen) knob to set a randomization type.
 - This is the parameter / function that will be randomized.
 - The range of values to choose from within the selected function will be set previously by 'Randomize'.
 - The value is applied globally, not individually per step.
6. Ensure the 'Randomize' parameter screen is displayed in view. Playing the pattern will generally apply the randomization while the randomize screen is displayed. Exiting the display to select another sample based parameter will also stop the application of randomization.
7. To print / fix the randomization to a track, Press [Save]. The current randomize setting will be now fixed into the track.
8. To reset the printed randomization on a track, Hold [Shift] + [Reset] in the randomize display. The current randomization is reset and ready for a new randomization to be applied. This can then be saved if required.

Randomize Examples

Randomize 0% - 100%.

X% sets the strength of randomization which refers to the range of values to affect. The parameter to randomize is set by the Randomize Type. Steps must be selected as well as the Randomize parameter page being actively on display for randomization to be applied.



Randomize
Randomize Type

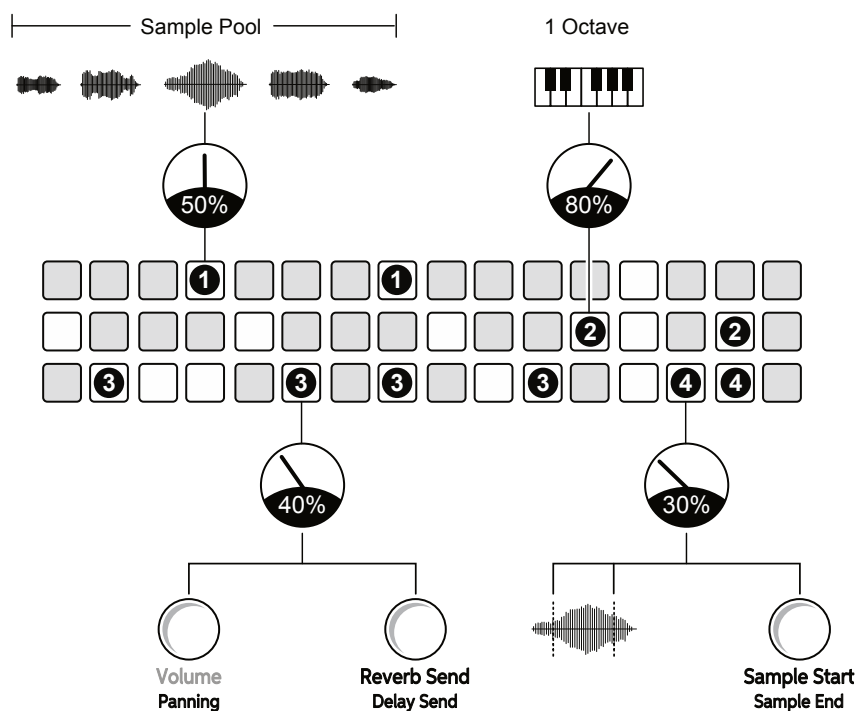

- 1** Randomize '50%' - Type 'Sample In Pool'
A sample will be selected randomly from within the sample pool. The selection of samples will operate across a range of 50% of the sample pool.
- 2** Randomize '80%' - Type '1 Octave'
The step note / event will play a notes from within an octave range. The notes will be selected across a range of 80% of the octave.
- 3** Randomize '40%' - Type 'Space'
The Space patch which consists of Panning, Delay Send and Reverb Send will be applied on the selected steps. The strength of parameter value application is based on the Randomize setting, in this case 40%. Try different % values for each step in the track.
- 4** Randomize '30%' - Type 'Sample Length'
Create glitchy steps, ideal for chopping samples randomly. Sample Start and End will adjusted within the 30% range.

8

Perform Mode

Perform is a dedicated mode designed to maximise the creative and ad lib experience when performing live. Perform supports improvisation and lays out a platform for the musician and producer to express themselves in an entertaining way. Perform mode, when selected, presents the 8 x 16 pad grid as a performance instrument. The Performance effects available in this mode are laid out across the pad grid in color coded sections which represent various effect categories. The punch-in effects are manually triggered by selecting a pad. Only one effect from each category can be selected at any one time. The last selected effect details will be displayed while the effect is selected when in Perform Mode. This means Play+ operates like an instrument during playback. Each pad will trigger a punch-in effect and coupled with the ability to adjust the function and parameter knobs, Play+ becomes a playable instrument

in itself. The Perform environment is self contained and any changes made in Perform mode will be turned off when exiting and when re-entering Perform mode latched effects are restored. This does not apply to knobs which revert to their original value and helps protect the production integrity when playing live. Also switching between Pattern and Perform modes also retains the performance effects although patterns cannot be edited in Perform Mode. Perform mode is only available for audio tracks and will disable the 'Live Rec' mode if active, when Perform is selected. The ability to improvise with Play+ demonstrates the focus on real time performance and on the fly creativity.

8 Perform Mode

8.1 Perform Mode.

NOTES

Perform mode presents a playable pad grid that generates punch-in effects. Parameter adjustments are also possible. This creates an environment perfect for live and improvised performances.

SELECTING PERFORM MODE

1. Press [*Perform*] Screen Button. Perform mode is only available for Audio tracks and is not available in MIDI Mode.
2. The Perform button tag on the display will illuminate yellow when in perform mode.
3. Perform Mode Considerations;
 - If 'Live Rec' mode is active when entering Perform Mode, it will automatically exit. If pressing [*Live Rec*] when in Perform Mode then Perform Mode is exited and Live Rec selected.
 - The following primary / secondary parameters are not available in Perform Mode: Repeat Type / Repeat Grid, Chance / Action, Move / Micromove. Other parameters can be edited in Perform Mode.
 - Any latched punch-in effects applied on the pads when exiting Perform Mode will be re-activated when re-entering Perform Mode. Not applicable to control knobs.
 - The display will show the effect selected when in Perform Mode.
 - The right side function buttons columns operate as normal re track selection, variations, mute and solo.
4. To exit Perform Mode, Press [*Perform*] again. The Perform button display tag will revert to white.
5. If selecting [*Patterns*] mode, the latched effects will remain in place.

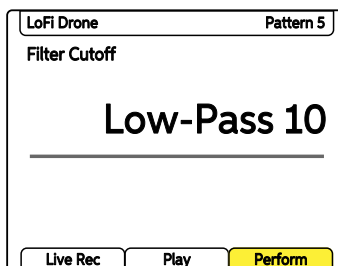

Where multiple settings exist on a track / selected steps a tilde ~ symbol will be displayed together with +/- for the generic offset.

USING PUNCH-IN EFFECTS IN PERFORM MODE

1. Press *[Perform]* Screen Button to select Perform Mode. The screen tag will be lit Yellow.
2. Select the Tracks to effect, Press *[Select]* Pad on the value button column to select each track to apply punch in effects. If no tracks are selected, a prompt will be displayed when selecting a perform pad.
3. Press *[Play]* or *[Shift] + [Play]* to play the selected pattern or chain of patterns respectively.
4. Tap *[Pad]* from the pad grid to latch the effect selection;
 - The 8x16 pads will illuminate in color. Each color represents a punch-in effect category each consisting of two columns, 16 pads of effect variations.
 - Tapping a pad will trigger and latch an effect. Holding a pad will temporarily trigger the effect. Selected effects are lit brighter than other pads.
 - Only one punch-in effect per category can be applied and latched at one time. Selecting another pad will deselect the existing effect and latch the new one.
 - The last selected effect will be displayed in the screen.
 - Some parameter knobs can be adjusted to add more variation.
 - All effect categories other than loop require a track to be selected.
 - If no track is selected then changes will not be audible. The exception is the Loop effects which remain audible.
5. Tap *[Pad]* again to deselect and unlatch a punch-in effect.
6. Press and Hold *[Pad]* to temporarily select a punch-in effect. The effect will be released when the Pad is released.

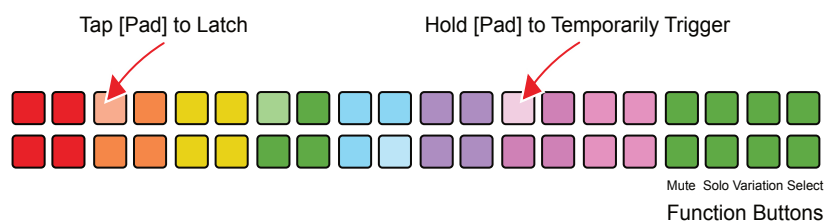

8 Perform Mode

8.2 Punch-In effects.

Perform Mode consists of 8 categories of effects, each has 16 pads representing a variation of the specific effect. The categories are color coded. One effect can be selected in each category at a time.

NOTES

Category	Color	Description
Tuning	Red	Changes the tuning with predefined +/- values
Filter Cutoff	Orange	Applies predefined Low-Pass or High-Pass Filter Cutoff settings
Distortion Effects	Yellow	Applies predefined values for Overdrive or Bit Depth parameters.
Rearrange	Green	Algorithm based preset which shuffles the playhead to rearrange steps.
Repeat	Cyan	Algorithm based preset which triggers step repeats.
Delay	Violet	Applies a delay preset punch-in effect.
Reverb	Purple	Applies a reverb preset punch-in effect.
Loop	Pink	Looped audio buffer-type punch-in effect. Master effect - does not require track selection.

8.3 Perform Mode Quick Reference.

Perform Mode presents the 8x16 grid pads as an instrument controller which allows punch-in effects to be manually triggered. The pads are color coded which represents one of the 8 headline categories of effect. Each pad then triggers a variation of the effect which can be a parameter value change, preset application or a change in the sequence. The screen display will indicate the last effect triggered when in Perform Mode.

Tuning		Cutoff		Distortion		Rearrange		Repeat		Delay		Reverb		Loop	
Semitones		%	%	%	Bits									Length	
-2	+2	10	10	30	12	Trig	Rep	Tripeat	SloStr	121	Twols	BigHa	Peas	4	4
-3	+3	20	20	40	10	Hattrk	End	EvrySt	LgaRth	Halfti	Warbl	Bedm	Dissolv	3	3
-4	+4	30	30	50	9	Averg	Tripler	Shorty	Grow	Fall SL	Rabbit	Late	DarkSt	2	2
-5	+5	40	40	60	8	Reorg	Brker	123	SloGlo	Stereo	String	Bright	Garage	1	1
-6	+6	50	50	70	7	Mash	Stomp	GoDW	GoUp	DimDI	Metal	DarkM	TuneV	1/2	1/2
-7	+7	60	60	80	6	Mirror	Tetris	ElvFal	3rdFlr	Piper	Shock	UCrisp	Sand	1/3	1/3
-9	+9	70	70	90	5	Clublb	Recog	Bloom	Void	Robot	StrinJr	LaterG	Bounce	1/4	1/4
-12	+12	80	80	100	4	Clubdb	Varibt	Pano1	Pano2	Tight	Super	Freeze	Radiat	1/8	1/8
Tune Down	Tune Up	Low Pass Filter	Hi Pass Filter	Overdrive	Bit Depth	Algorithm	Algorithm	Algorithm	Algorithm	Delay Preset	Delay Preset	Reverb Preset	Reverb Preset	Loop	Loop LR
Tuning		Cutoff		Distortion		Rearrange		Repeat		Delay		Reverb		Loop	

Perform Mode: Press [Perform]

Latch / Unlatch an effect: Tap [Pad]

Temporary Trigger an effect: Hold [Pad], Release [Pad]

Ensure tracks are selected to apply effects.

Effects

A number of audio effects are available in Play+ including Reverb, Delay, Limiter, Saturation and Sound available under the Master FX section. Sound and Saturation are applied at the main output stage. Play+ presents the master effects settings as presets in order to avoid complexity and to speed up the workflow. This includes EQ, Bass Boost and Space which are also integrated into the presets for main output sound FX. The limiter includes a sidechain function. Sidechaining can be a useful and creative technique where a separate sound source can control the dynamics. Play+ limiter has the options of using separate tracks as the sidechain source. Delay and Reverb operate as send effects. The amount of effect audio sent to the main mix can be controlled per step. Play+ also has a filter which operates as a DJ style low pass or high pass filter depending on the parameters set. Some sound options may

affect the stereo spread, increasing its strength and which in turn may affect phasing. The Flat preset option is a safe starting point or a preset to revert to if unwanted phasing issues are experienced. It is always worth remembering that adjustment by ear is usually a more appropriate method when applying effects. While theoretical numbers and parameters are often starting points, Play+ steers away from an overload of parameter settings. After all, Play+ is designed to get things moving quickly and to focus on playing and performing more so than iterative parameter configuration. Having said that, the option to set custom parameters is also available for the Reverb, Delay, Sound and Limiter. These can be set in the Master FX section. There is no better method than to listen how sound output is affected through the sound design process and to focus a little less on the visual numbers configured.

9 Effects

9.1 Effect Architecture.

NOTES

Play+ has various effects which operate in different configurations. Sound FX and Saturation enhance the main output, while Delay and Reverb can be mixed into the main sound from each step or track. Many effects operate using presets found in the Master FX menu although custom setting are also possible. The mixer is an internal function with no user adjustable parameters. The diagram is for illustration purposes and indicates the user available parameter options.

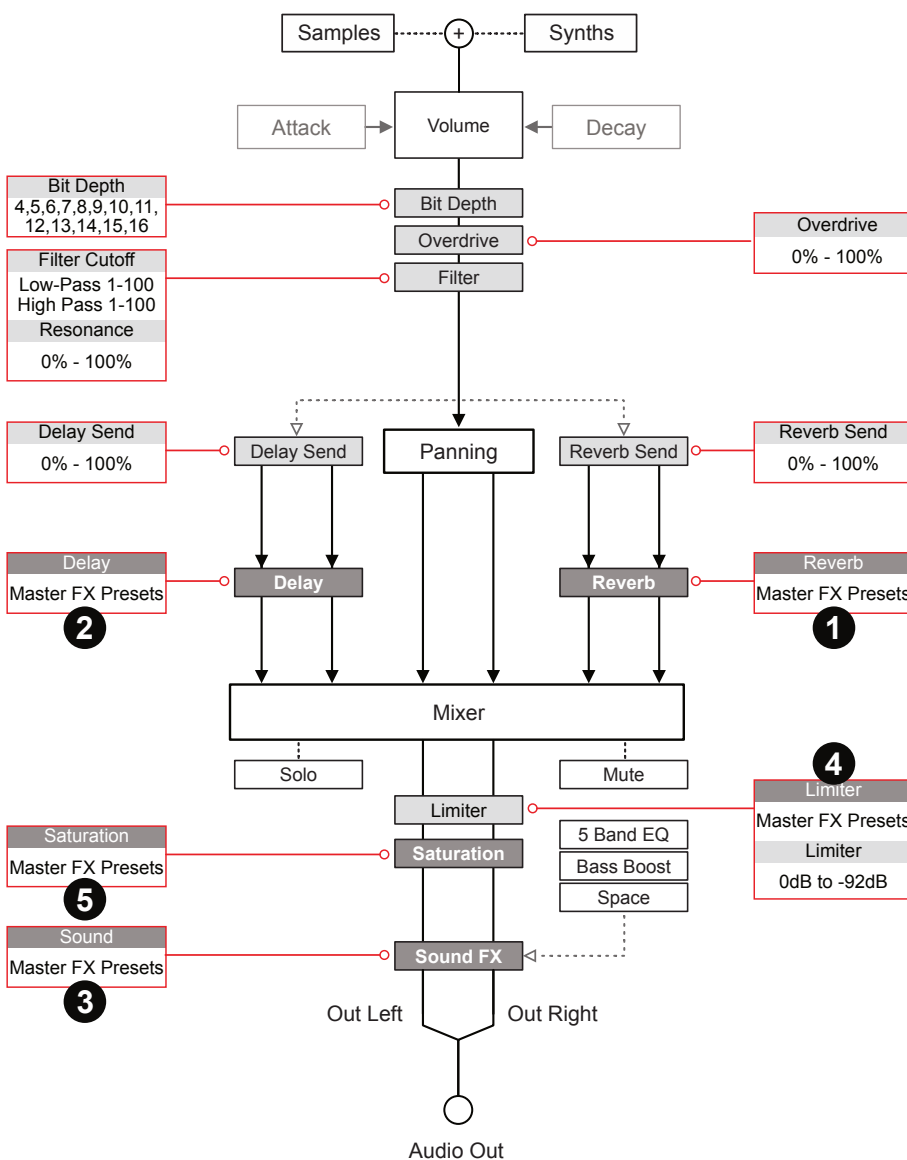

- Effect Preset available in the [Shift] + [Master FX], Master FX Menu
- Effect Parameter available directly on knob

Master FX Presets - Hold [Shift] + [Master FX]

Reverb 1

- Big Room *
- Small Room
- Uncharted
- Drone
- Analog Repeats
- Late
- Bounce
- Stereo Drums
- Bright Sky
- Space
- Transparent Hall
- Custom

Limiter 4

- Squishy
- Boom
- Release Me
- Slo Attack
- Heavy
- Nice and Low *
- Broken Bones
- Squish That Cat
- Distortion
- Waves
- Sidechain Track 1
- Sidechain Track 2
- Sidechain Track 3
- Sidechain Track 4
- Sidechain Track 5
- Sidechain Track 6
- Sidechain Track 7
- Sidechain Track 8
- Custom

Delay 2

- Dubster *
- Triple Dubster
- Bucket
- Nanorobot
- Widea
- Brighteen
- Monoroom
- Stereoroom
- Pipe
- Degradah
- Mononono
- Cleanio
- Twoism
- Warbliani
- Rabbithole
- Stringston
- Metalhead
- Shock
- Stringston Jr
- Superfario
- Custom

Saturation 5

- Hard Clip
- Soft Clip *
- Saturate
- Overdrive
- Overdrive+

Sound 3

- Flat *
- Clean Mix
- Scoopy Doo
- Boom Box
- Outside
- Radio Call
- Bass Mid Push
- Wide
- Sounds Good
- Gradual
- Fifuci Boost
- Custom

* Default Presets

9 Effects

9.2 Master FX Presets.

The delay, reverb, sound, limiter and saturation as controlled by one of several defined presets. The parameters are therefore hidden under the hood for most functions and the preset itself defines the style and sound generated. The presets are selectable with the Master FX section.

SELECTING A MASTER FX PRESET

1. Hold [Shift] + Press [Master FX]. The Master FX option is the secondary function on the 'View' Button.
2. Turn (Screen) knob to scroll through the effects; Reverb, Delay, Sound, Limiter, Saturation. The currently active preset will also be displayed for each effect. Highlight the effect to change.
3. Press (Screen) knob to select and open the preset list for the highlighted effect. The preset names are designed to give an indication of the type of sound to expect.
4. Turn (Screen) knob to scroll through and highlight the preset to select. Press (Screen) to select the preset. It is good practice to listen to the impact of the effect to help chose the best option.
5. Press [Back] to backup and then exit the menu.

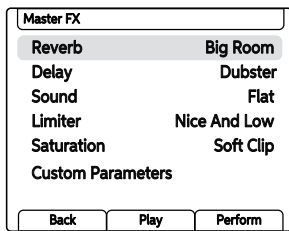

Hold [Shift] + [Master FX].

Currently loaded Master FX preset is displayed alongside each effect.

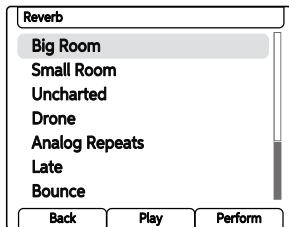

A collection of effect presets are available for each effect.

9.3 Master FX Custom Parameters.

The basic workflow for using the Master FX is to start with an effect preset. This is useful for most applications. More precise adjustments can be made within the custom parameters. A 'Custom' preset option is available for some of the effects and these can be set up under the 'Custom Parameters' option at the Master FX main menu.

Available Customer Parameters per Effect

Effect	Parameter	Range
Reverb	Damping	0-100
Reverb	Size	0-100
Reverb	Diffusion	0-100
Reverb	Predelay	0-100
Delay	Sync Rate	8 - 1/32
Delay	Feedback	0-100
Delay	Ping Pong	On/Off
Delay	Ping Pong Ratio	0.5000 - 1.000 (0.005 iterations)
Delay	Filter Frequency	0Hz - 22,000Hz (20Hz Iterations)
Sound	EQ 115 Hz	-11.75 dB to +12 dB
Sound	EQ 330 Hz	-11.75 dB to +12 dB
Sound	EQ 990 Hz	-11.75 dB to +12 dB
Sound	EQ 3000 Hz	-11.75 dB to +12 dB
Sound	EQ 99000 Hz	-11.75 dB to +12 dB
Sound	Bass Boost	0-100
Sound	Space	0-8
Limiter	Attack	0.05ms - 10.00ms (0.05 iterations)
Limiter	Release	5ms - 5000ms (5ms iterations)
Limiter	Sidechain	On/Off
Limiter	Sidechain Channel	Track 1 - Track 8

EDITING A MASTER FX CUSTOM PRESET

1. Hold [Shift] + Press [Master FX]. The Master FX option is the secondary function on the 'View' Button.
2. Turn (Screen) knob to scroll and highlight 'Custom Parameters'.
3. Press (Screen) knob to select and open the custom preset list. Each of the configurable effects is listed.
4. Turn (Screen) knob to scroll through and highlight the effect to edit. This will edit the parameters for the 'Custom' preset, selectable in the effect preset options.
5. Press (Screen) to select the effect to edit.
6. The selection of editable parameters for the selected custom effect are listed. These can be selected by Turning and Pressing (Screen).
7. Each parameter is selected by pressing (screen) and edited individually by turning (Screen)
8. Press [Back] to back up when the parameter editing is complete.
9. Repeat Steps 7-8 to configure other parameters.

SELECTING A MASTER FX CUSTOM PRESET

1. Hold [Shift] + Press [Master FX]. The Master FX option is the secondary function on the 'View' Button.
2. Turn (Screen) knob to scroll through the effects; Reverb, Delay, Sound, Limiter, Saturation. The currently active preset will also be displayed for each effect. Highlight the effect to change.
3. Press (Screen) knob to select and open the preset list for the highlighted effect. The preset names are designed to give an indication of the type of sound to expect.
4. Turn (Screen) knob to scroll through and highlight the 'Custom' preset. This is the last option in each effect list and reflects the parameters assigned in the 'Custom Parameters' Settings.
5. Press (Screen) to select the custom preset.
6. Press [Back] to backup and then exit the menu.

9.4 Send Effects.

The delay and reverb effects are both send effects. This means that a selected amount of audio signal can be controlled and sent to the main effect. A parameter knob exists to control the send amount which can be applied to individual steps or full tracks.

Example of Send Effect, Delay.

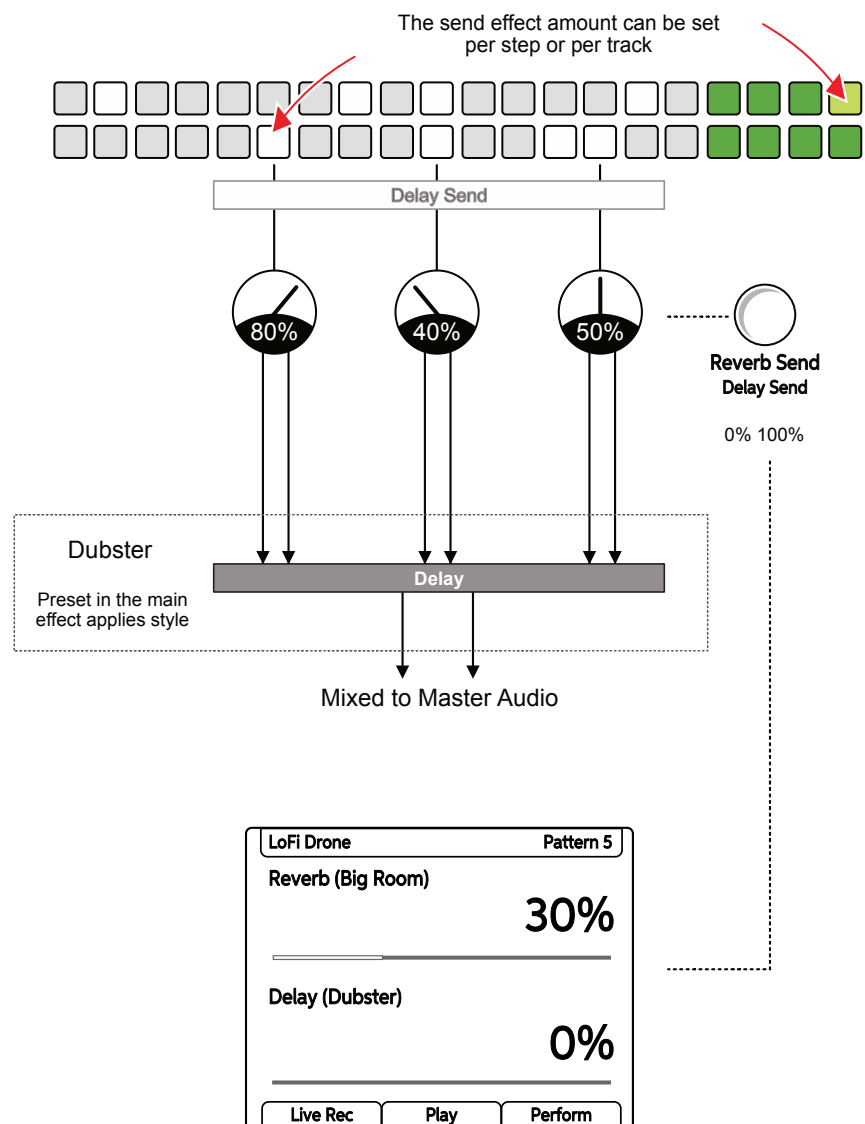

9 Effects

9.5 Master Reverb.

NOTES

Reverb is one of the two send effects. As stated a send effect routes an adjustable amount of audio in parallel to its main signal path and is sent to a common audio effect. In this case reverb. This reverb affected audio is then returned back to the main audio path. The effect itself is a common function, managing several send / return signals.

What is a reverb effect?

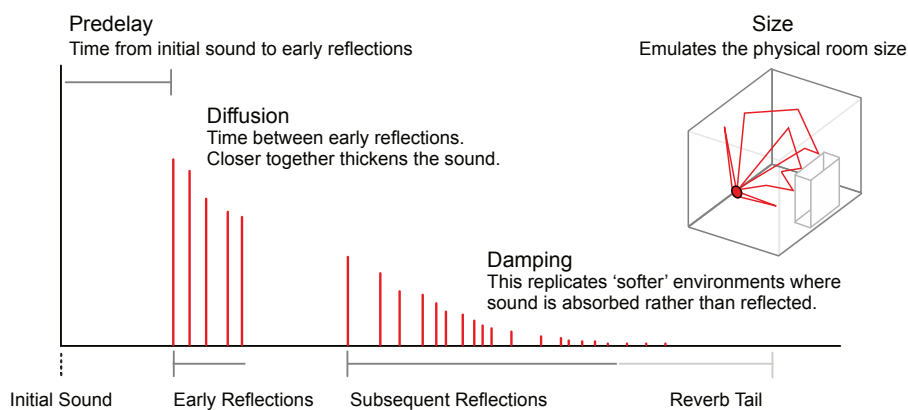

A reverb is a common production effect used to replicate the audio behaviour of spaces. A normal space such as a small or large room will reflect audio differently. Think of how the sound reflects in a large cathedral compared to a small room and how furniture absorbs or reflects sound. The sound will bounce and reflect between the walls and other elements in the room. These reflections arrive at the human ear at different times and different levels. Reverb is an effect that replicates this behaviour.

Reverb parameters mainly focuses on the space / room characteristics. The detailed parameters are set and locked into the preset.

In Play+ there are two factors that can be controlled for reverb:-

- The send amount between 0% - 100%. This is set with the 'Reverb Send' Parameter knob and is applied to individual steps or a track. Tap to select the primary, Reverb Send parameter and adjust with the Parameter knob or (Screen) knob.
- The preset which will automatically configure the style and character of the main reverb. This applies to the main FX and therefore will take input from all send signals.

A series of reverb patches can also be triggered in Perform Mode.

9.6 Master Delay.

Delay is second of the two send effects. A send effect basically routes an adjustable amount of audio in parallel to its main signal path and is sent to a common audio effect. In this case delay. This delay affected audio is then returned back to the main audio path. The effect itself is a common function, managing several send / return signals.

What is a delay effect?

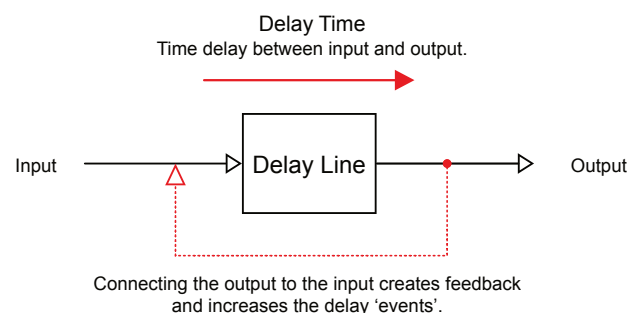

A delay is a commonly used audio effect which delays an incoming signal to the output. When feedback is applied, this creates a repeated echo like effect. While this is a simple principle there are many effects that use delay as a foundation. Some examples as well as echo are chorus (short delay taps to give a thicker rather than echo style feel), ping-pong delay (spreading the delay points across the stereo field left to right) and slap-back delay (emulating old tape delays which are used successfully to thicken vocals).

Delay is a time based effect and is typically synchronised (or not) with the track tempo. The detailed parameters are set and locked into the preset.

In Play+ there are two factors that can be controlled for delay:-

- The send amount between 0% - 100%. This is set with the 'Delay Send' Parameter knob and is applied to individual steps or a track. Tap to select the secondary, Delay Send parameter and adjust with the Parameter knob or (Screen) knob.
- The preset which will automatically configure the style and character of the main delay. This applies to the main FX and therefore will take input from all send signals.

A series of delay patches can also be triggered in Perform Mode.

9 Effects

9.7 Distortion Effects.

NOTES

There are several effects that control the style of distortion. Overdrive and Bit Rate can be applied at step and track level while Saturation is fixed as at the master output and is applied to the entire main output audio.

Overdrive: Adds grit and amplification to a sample audio signal. Overdrive emulates the classic audio speaker / monitor character which adds distortion through driving the signal hard into the speaker / amplifier. Overdrive can be applied at step or track level where the amount is controlled between 0% - 100%.

Bit Depth: Digital audio is made up of a number of characteristics including sample rate and bit rate. The quality of the audio can be determined by these parameters. Reducing the number of bits in the audio signal will deteriorate the audio quality producing a more lo-fi sound. Bit depth changes can be applied at step or track level where the amount can be adjusted down from 16 bits to 4 bits.

Saturation: Historically saturation is created from overloading analog electronics. This is applied at the main audio output level to give a more distorted output. When used as a subtle effect the audio signal will have a warmer, analog feel. The preset can be assigned to give the style and character but there are no other adjustable parameters.

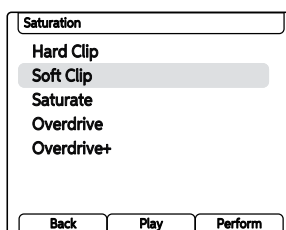

9.8 Limiter.

A limiter is a dynamic processor used to control volume levels and also to avoid clipping. Play+ has a limiter located in the master output section. The limiter also has sidechain functionality through the selectable presets.

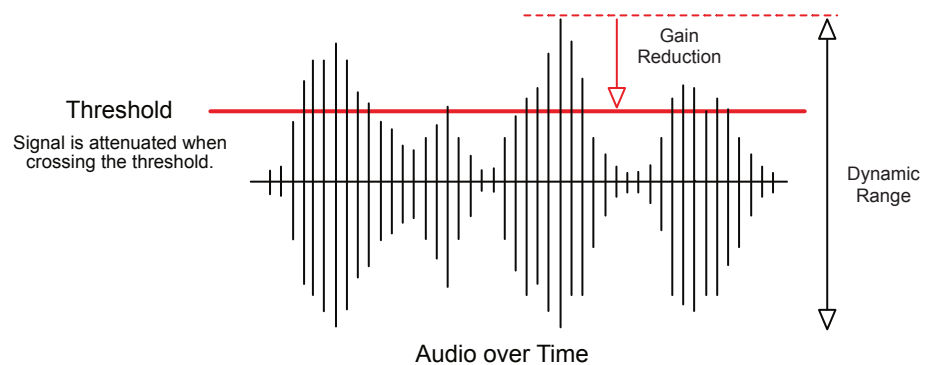

The behaviour of a limiter can be controlled by envelopes and may include many other features. In Play+ the behaviour and limiter style is 'hard wired' into a number of available presets.

An option often seen within limiters is to sidechain the gain reduction. This means another source will be used to attenuate the audio based on the source audio sound characteristics. In Play+, any track can be used as a sound source for sidechaining the limiter.

The threshold is the only adjustable parameter in Play+ and is controlled with the limiter parameter knob.

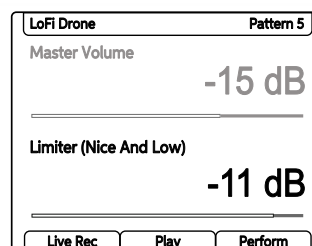

The limiter is accessed as the secondary option on the Master Volume control. Double tap the knob to select.



ADJUSTING THE LIMITER THRESHOLD

1. Double Tap (Limiter) to select the parameter and display the values.
2. Turn (Limiter) to adjust the threshold level between -92dB to 0dB. The adjustment will be in 1dB iterations.
3. Hold [Shift] + Turn (Limiter) to adjust the larger iterations.

CHANGING THE LIMITER PRESET

1. To change the limiter preset, Press [Shift] + [Master FX] to open the Master FX menu options.
2. Turn (Screen) to scroll the menu and to highlight the 'Limiter' option.
3. Press (Screen) to open the limiter preset options list.
4. Turn (Screen) to scroll the preset options. Highlight the desired preset. It is recommended to try out presets with the project to see what fits best to the musical style and production.
5. Press (Screen) to select. The selected preset is displayed in the limiter display in brackets after the limiter title.
6. Press [Back] to exit the Master FX menu.

Limiter Presets

Squishy	Boom	Release Me	Slo Attack	Heavy
Nice And Low	Broken Bones	Squish That Cat	Distortion	Waves
Sidechain Track 1	Sidechain Track 2	Sidechain Track 3	Sidechain Track 4	Sidechain Track 5
Sidechain Track 6	Sidechain Track 7	Sidechain Track 8		

CREATING A SIDECCHAIN FOR THE LIMITER

1. To change the limiter preset, Press [Shift] + [Master FX] to open the Master FX menu options.
2. Turn (Screen) to scroll the menu and to highlight the 'Limiter' option.
3. Press (Screen) to open the limiter preset options list.
4. Turn (Screen) to scroll the preset options. Highlight one of the 'Sidechain Track X' options. The Track X must be a Play+ track that will be used as the sidechain audio source. Typically a beat orientated sound works well to rhythmically duck the limiter audio level.
5. Press (Screen) to select. The selected preset is displayed in the limiter display in brackets after the limiter title.
6. Press [Back] to exit the Master FX menu.
7. Playing the limiter source track will now be applied to drive gain reduction in sync with the musical rhythm of the source track. Turn to adjust the (Limiter) parameter to apply the amount of sidechain ducking.

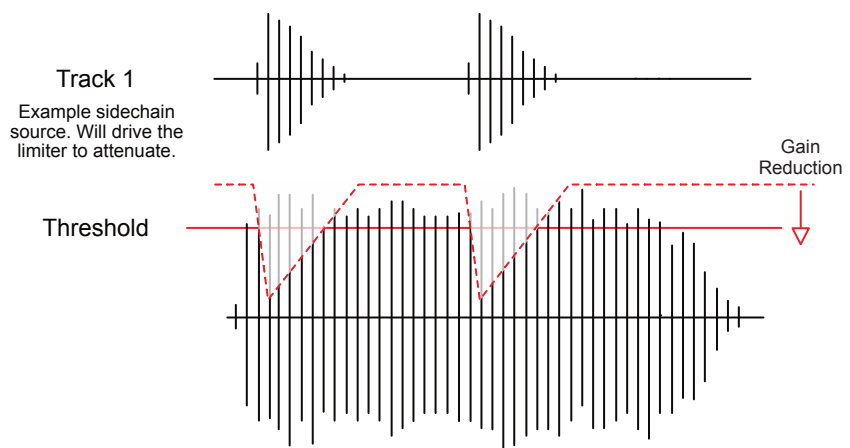

Audio over Time

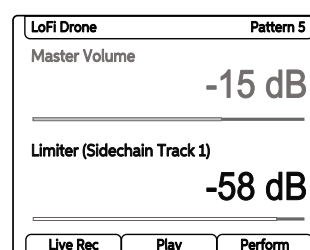

10

MIDI

Play+ also has a set of comprehensive MIDI features. MIDI is the protocol which allows devices to communicate together, for example where one device controls sequencing to send to another synth. MIDI is a classic technology but remains an important feature in most modern audio devices. Most of the processes and instructions described earlier for audio also apply to MIDI sequencing. MIDI mode integrated with the Synth options. So the [Audio/MIDI] button can switch between working with 8 audio sample tracks or working with 8 MIDI / Synth tracks. Play+ therefore can control external gear from its sequencer and external gear can also be set up to control Play+. A few fundamental things should be considered when working with MIDI. The clock in a multi gear setup will control timing between devices. As such only one main clock should be declared. Also the transport of which device will stop and start the sequencing.

These of course are design choices taken when organising a collection of equipment to work together with MIDI and should be considered at the outset. MIDI in Play+ can be set up through the USB connection or the MIDI interface which uses supplied Type B MIDI adapter cables to convert the 3.5mm connection to standard 5-Pin DIN style MIDI connections. MIDI expands the landscape of sound design when using Play+ in a setup. The MIDI Fill functions and piano roll expand the options when working with MIDI even further. Play+ has built in configuration for direct integration to Polyend Tracker but also connection with many other MIDI synths, instruments, sequencers and effects is possible.

10 MIDI

10.1 MIDI Terms.

NOTES

To clarify some of the generic terminology and technology around MIDI, a summary of key definitions is provided. Play+ uses a Type B, TRS to MIDI Adapter. Also MIDI over USB is possible.

5 PIN MIDI



5 PIN to TRS MIDI



MIDI DIN 24

This is often found for MIDI Out and Thru and enables syncing of classic devices. This uses 0v & 5v messages as sync signals at 24 pulses per quarter note (PPQN).

MIDI DIN 48

This is often found for MIDI Out and Thru and enables syncing of classic devices. This uses 0v & 5v messages as sync signals at 48 pulses per quarter note (PPQN).

MIDI

Musical Instrument Digital Interface. A protocol for communicating between electronic musical gear. Never connect MIDI gear to incompatible DIN signals. Play+ has USB MIDI but also an interface for 5 Pin DIN In and out.

MIDI CC

MIDI Continuous Control change messages are used to communicate messages across MIDI with values of 0-127. CC Changes affect parameter values while note data triggers notes. Play+ has some defined CC assignments.

MSB & LSB

Most Significant Byte and Least Significant Byte. MSB provides the 128 data resolution which is ok for most MIDI applications. More advanced devices use MSB and LSB values increasing resolution to 16,384 steps.

MIDI STANDARDS

While there are MIDI standards defined, many synth developers interpret this in slightly different ways. Its always worth reviewing the documentation with each to fully understand each device level implementation.

NRPN

Non-Registered Parameter Number is part of the MIDI standard. CC and NRPN are technically very similar but NRPN is less well defined in the standards. NRPN uses more data and can give better control. Not supported by Play+.

SYSEX

System Exclusive. This is an expansion of the normal MIDI communications set up and is typically used for transferring data such as back ups, patches, presets and firmware updates to and from devices. Not supported by Play+.

SDS

Sample Dump Standard. This is an older transfer protocol used for transferring data to and from devices. This is rarely seen nowadays.

The term 'primary lead' will refer, in this guide to a device that has the main control responsibility. For example controls the clock and transport and is the central lead. A device which will be controlled by, and follows the primary lead device and which will be subservient by responding to the main control messages will be called a 'secondary follower'.

10.2 Basic MIDI concepts for Play+.

Play+ can be switched to MIDI mode when controlling external gear. MIDI mode is selected using [Shift] + [Audio/MIDI]. MIDI / Synth mode is indicated by the 4 column function pads being lit purple. A pre-requisite to working with MIDI is to ensure that the configuration settings are applied for the desired MIDI gear setup and a MIDI device selected using (Sample). MIDI Mode operates at a per step level. The parameter knob switches functionality from their faceplate labelled audio parameters to the unlabelled MIDI functions. The display will show the MIDI Parameter. Play+ can assign note data and specific channel settings at a step level to send MIDI out from the sequencer pattern.

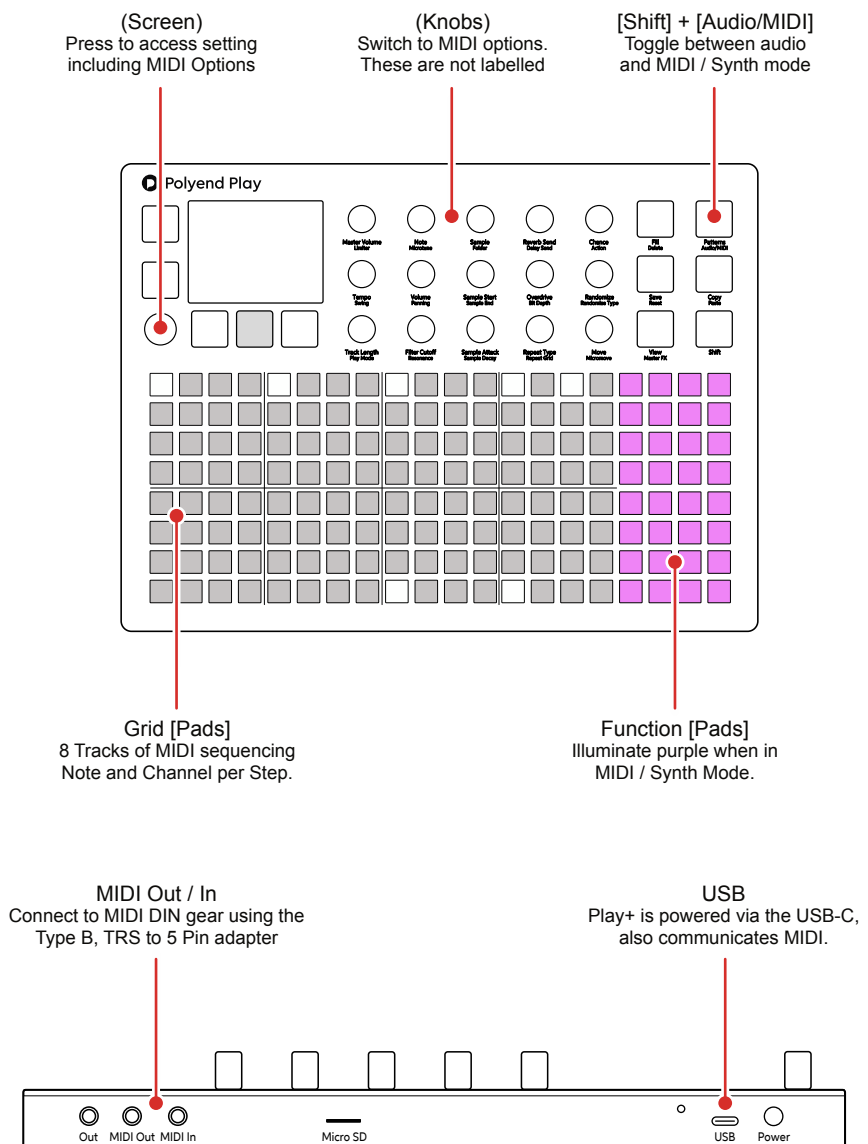

10 MIDI

The following points should be considered and questions answered when working with MIDI configurations:-

- How the devices are connected together? Are the devices connected by USB? Which will transmit and receive MIDI with the MIDI 5 Pin connection using the MIDI Jack adapter? Play+ can use one or the other or both.
- Which device will be a primary leader (main device e.g. controls the main clock) or a secondary follower (will respond to other gear e.g. synchronised to another clock)? Play+ will issue a warning message if the external MIDI clock assigned from the primary device is lost or is disconnected.
- When Play+ sends MIDI clock it will continue to do so even if the sequencer is stopped. When Play+ receives a MIDI clock the tempo will reflect the external controller BPM.
- Will MIDI note data (melodies, chords, etc) be communicated? Play+ has a 'No Note' option in MIDI mode. Useful for example when using CC values which can be applied per step note or on 'No Note' steps.
- Will MIDI CC control change data be communicated out (to change parameters like delay level or trigger performance effects)? Play+ knobs can control the CC values dynamically when the sequencer is stopped.
- The default CC configurations in Play+ do not necessarily match the destination device. Check the device MIDI mappings for each device in the manufacturers documentation.
- Play+ does not support MIDI NRPN or Sysex messages.
- Play+ operates internally with 96 PPQN - Pulses Per Quarter Note for MIDI Timing but communicates at 24 PPQN.
- Track mutes do not mute Continuous Control Change, Pitch-bend or Program Change messages. Use alternate track variations with no CC, PB or PC to silence these messages.

10.3 MIDI Configuration.

MIDI Settings are accessed by pressing the (Screen) Knob. These will dictate if Play+ leads on functions like clock and transport or if it acts as a secondary follower, responding to control and synchronisation from another primary device control.

Play+ can send MIDI notes out from the sequencer pattern, with the output channel assigned per step as well as the other note parameters.

Menu	Option	Description
MIDI	CC Mapping Sub Menu	Opens sub menus for setting the control change message mapping for channels 1-16 for the MIDI connection or for the USB connection.
MIDI	Clock In	Sets the Play+ clock input for internal generated clock (default) or an external clock received through the USB Input or MIDI In jack. Tempo reflects external device BPM. A warning message is by Play+ displayed if the external clock is lost.
MIDI	Transport In	Sets the source of transport control commands, off (default), or control from an external device received through the USB or MIDI In jack.
MIDI	Clock Out	Sends the Play+ clock output to other devices. Off, USB, MIDI Out jack or USB+MIDI jack options.
MIDI	Transport Out	Sends Play+ transport control commands to other devices. Set to Off, USB, MIDI Out jack or USB+MIDI jack options.
MIDI	Notes In	Sets the input of how notes are received from an external device. Set to Off, USB, MIDI In jack or USB options.
MIDI	Notes In Channel	Sets the MIDI channel for external note inputs. Select All channels as Omni or Channel 1-16.

ACCESSING THE MIDI CONFIG OPTIONS

1. Press (Screen) knob to open the configuration menu.
2. The entry point of the menu may be in one of the submenus. Press [Back] to backup to the main menu if required.
3. Turn (Screen) to navigate the menu and highlight 'MIDI'.
4. Press (Screen) knob to select the MIDI options.
5. The Settings can be changed by Pressing (Screen) on any option to select its options. The CC Mapping option opens the sub menu for setting the control change messaging.

10 MIDI

10.4 MIDI Quick Start.

NOTES

To get up and running with basic control of external MIDI devices here is a quick start guide to programming a MIDI sequence including Notes and CC messages. Further depth to using MIDI will expand throughout this section. The general principles of setting steps and using work step parameters is applied the same as audio patterns.

CREATING A MIDI SEQUENCE

1. For this example ensure that the device to control, i.e. an external synth, is connected via MIDI DIN Out. USB also transmits MIDI. Ensure it receives clock, transport and notes on channel 1.
2. Press (Screen) knob to open the configuration menu. Set the MIDI Settings to Clock In = Internal, Clock Out = MIDI Out Jack, Transport In = Off, Transport Out = MIDI Out Jack.
3. Switch Play+ to MIDI Mode. Press [Shift] + [Audio/MIDI]. The Function buttons will be lit purple as opposed to green when in audio mode.
4. Press a [Select] Pad to choose one or more tracks or simply program the Grid [Pads] to sequence a pattern. Hold the step to apply and edit the parameters to only selected steps or use work step approach to set the values followed by programming the steps. Following examples are per step.
 - Hold [Pad] + Turn (Sample) to assign MIDI output channel. This can be set 1-16 for MIDI Jack and also separately for USB. Set to Jack Channel 1.
 - Hold [Pad] + Turn (Note) to assign a note to output. The option to set 'No Note' is possible which is useful to just send CC or PG data without a note message.
 - Hold [Pad] + Turn (Volume) to set the Velocity for the step.
 - Double Tap (Panning) to ensure the secondary option is in view. This is Note length in MIDI Mode. Hold [Pad] + Turn (Panning)
 - Optionally, Hold [Pad] to assign a CC value to the step. Knobs can be assigned to send CC messages with defaults in place. With the sequencer stopped manual CC knob changes are sent while steps should be programmed for a sequence of CC change messages to be sent in sync to the pattern steps.
5. Press [Play] on Play+ and the sequence will play the external device based on the notes and parameters set.

10.5 Typical MIDI Configurations.

There are many configurations that can be set up with MIDI gear. Some are complex and involve multiple devices while a simple set up can have two devices communicating. Some typical examples are shown.

Example Configuration 1: Play+ as the primary lead connected to Elektron Digitakt. MIDI Mode On.

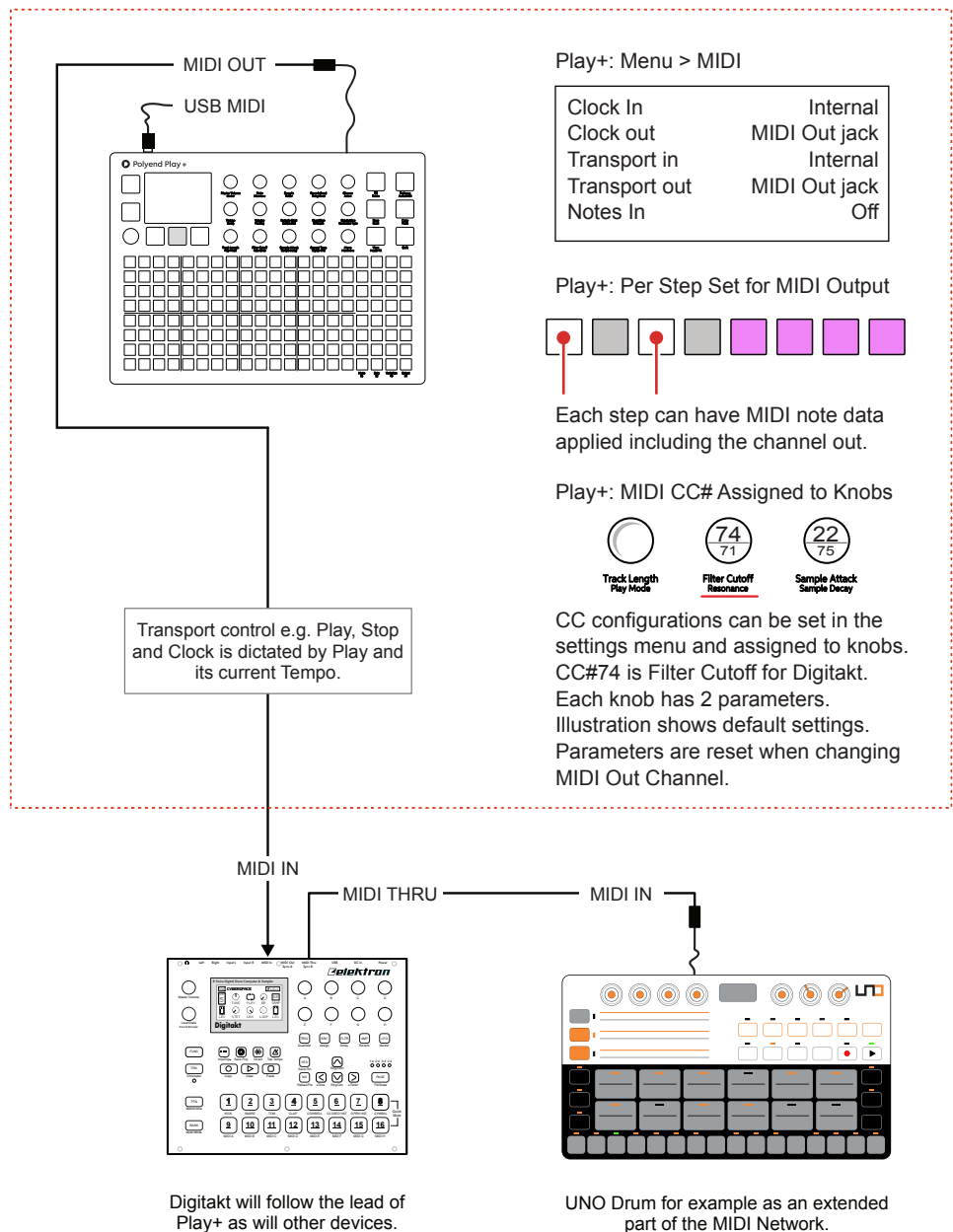

Devices should be configured to receive clock and transport and the MIDI Channel which Play+ communicates out, for example, Channel 1. CC 74 In Digitakt represents the Filter Cutoff frequency in this example notes are played per step and the knob controls filter.

10 MIDI

The ability to connect to a PC or Mac via a MIDI connection is possible, which can allow software synths and plug-ins to be controlled by Play+. Play+ will need a hub or will need to be powered by the PC / Mac as the USB connection is also the source of power for Play+.

Example Configuration 2: Play in / out with Ableton Live.

Play+: Menu > MIDI

Control DAW from Play+		Control Play+ from DAW	
Clock In	Internal	Clock In	MIDI In USB
Clock out	MIDI Out USB	Clock out	Off
Transport in	Off	Transport in	MIDI In USB
Transport out	MIDI Out USB	Transport out	Off
Notes In	Off	Notes In	MIDI in USB
		Notes In Channel	Omni

While in this example Play+ will predominately control the DAW, Notes can be received and recorded from the DAW into Play+ tracks. When recording into Play+ ensure alignment of the track length and 'select' the tracks to record into.

Transport control e.g. Play, Stop can be set by DAW or Play. It is advised to defined which device controls the clock.

1 Plugin A

2 MIDI

MIDI on Channel 1 from Play+ steps, controls the plugin synth in the Live track.

MIDI on any channel from Live will control Play+ when Play+ 'Notes In Channel' option is set to Omni.

Link EXT 102.00

MIDI settings in the Live preferences page will need to be set 'On' for MIDI Ports, Input & Output. When controlling to/from Play+. The 'Ext' function, in Live should be on to use external sync settings and for tempo to be synchronised from Play+.

Ensure receiving track is armed for recording to preview the audio also to recording incoming MIDI notes.

NOTES

An external device, keyboard or drum pads can be connected to control Play+ by MIDI either by USB or via the 5 Pin MIDI dongle. Notes can be played or recorded and CC messages controlling assigned parameters.

Example Configuration 1: Play+ as the secondary follower controlled with Arturia Keystep.

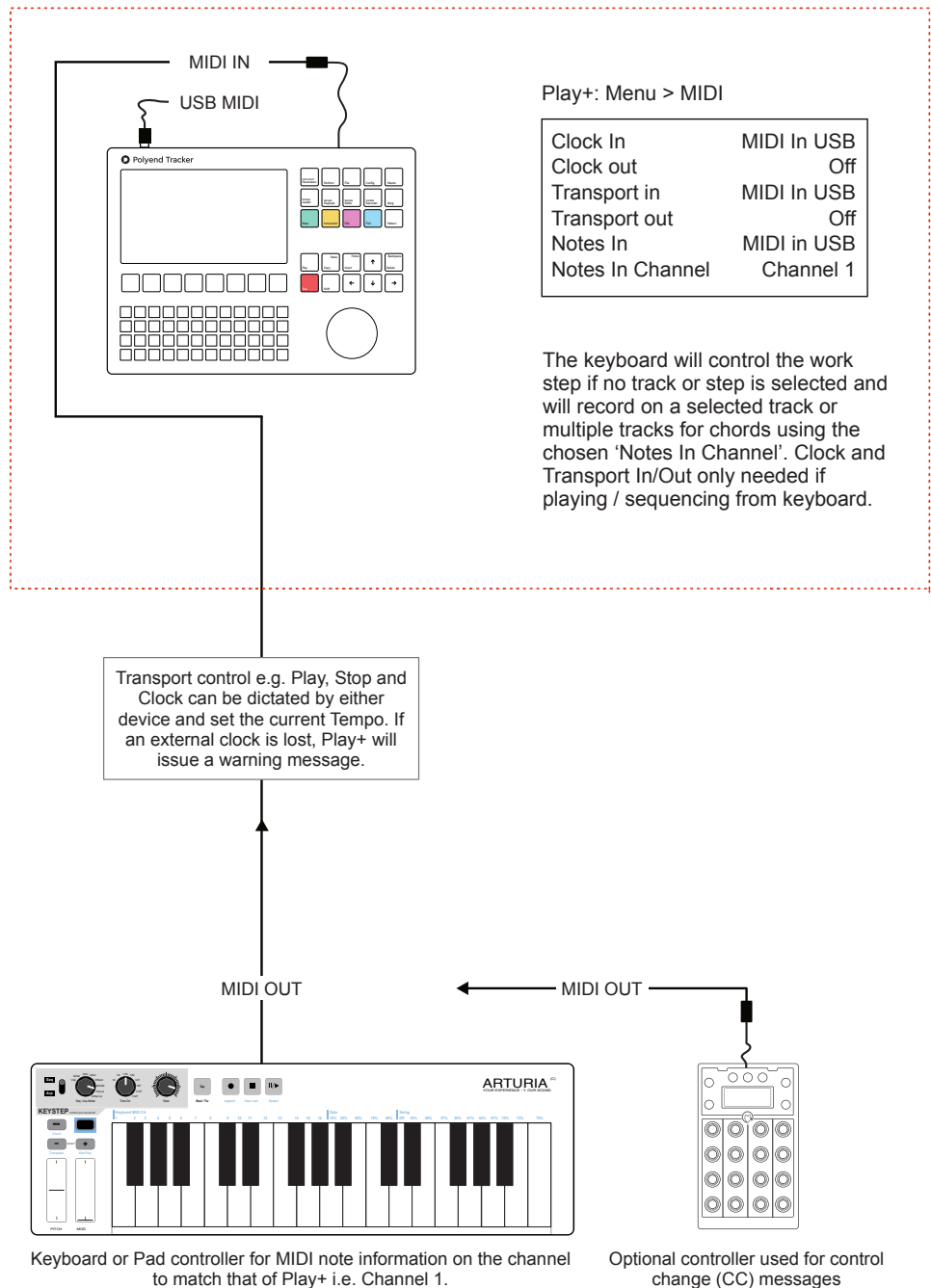

10 MIDI

10.6 MIDI Mode.

NOTES

Play+ must be in MIDI Mode to program steps and send MIDI data out. The parameter options change when in MIDI mode where the knobs represent MIDI orientated functions. These are not labelled and some can be configured specifically in the MIDI menu.

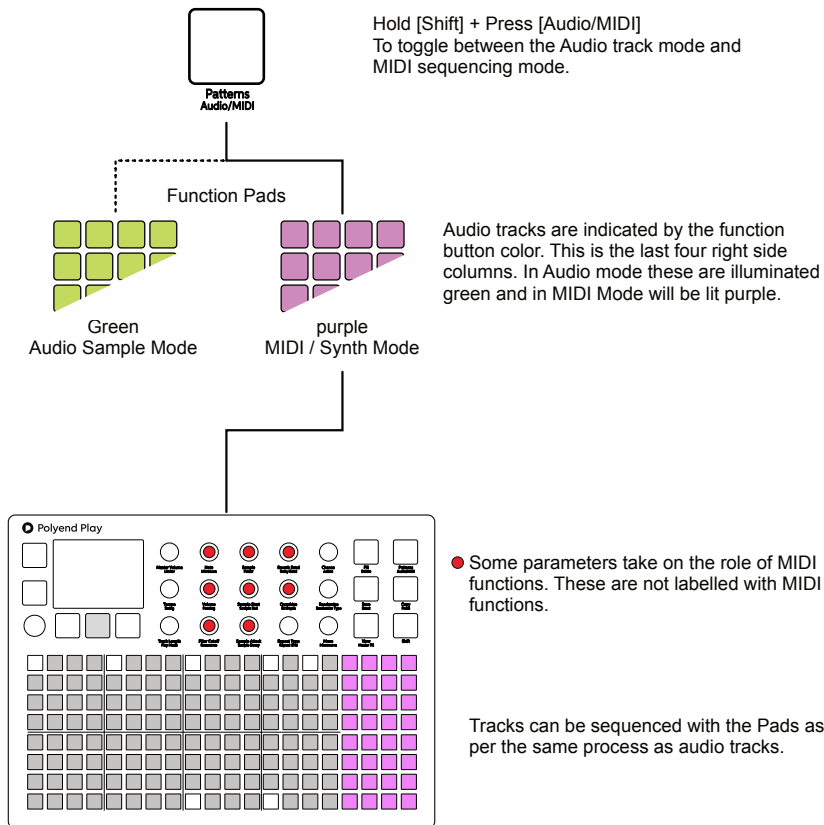

MIDI Mode Parameters

MIDI Mode, MIDI Specific parameters are not labelled in the list by it's MIDI function but will refer to the Audio Mode labels. The configuration can be set in the MIDI settings.

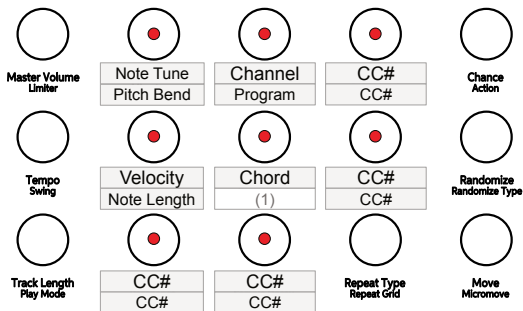

... Mapping > Jack Channel 10	
CC Cutoff	74
CC Resonance	71
CC Sample Attack	22
CC Sample Decay	75
CC Reverb Send	17
CC Delay Send	19
CC Overdrive	12
Back	Play

(1) reserved for future Use.

Parameters in MIDI Mode.

Label	MIDI Mode	Description
Master Volume	Master Volume	Controls Play+ main output level.
Limiter	Limiter	Controls Play+ main output limiter threshold.
Tempo	Tempo	Controls / Displays Tempo.
Track Swing	Track Swing	Controls Play+ swing amount.
Track Length	Track Length	Adjusts number of steps in the track.
Play Mode	Play Mode	Determines the order of the track steps.
Note	MIDI Note Tune	Tunes the MIDI note in semitone steps.
Microtune	Pitch bend	Pitch bend out -100 to +100.
Volume	Velocity	Note velocity transmitted
Panning	Note Length	Length of MIDI Note, 1 Step at global tempo
Filter Cutoff	CC	CC Number assignable in MIDI Settings Menu. Default is CC#74
Resonance	CC	CC Number assignable in MIDI Settings Menu. Default is CC#71
Sample	Channel	MIDI Port & Channel per Step. 16 channels for MIDI Jack and also 16 for MIDI USB. Work step Parameters are reset when changing channel.
Folder	Program	Program change message 0-127
Sample Start	Chord Type	MIDI Chord selection from pre-programmed set
Sample End		Reserved for Future Use
Sample Attack	CC	CC Number assignable in MIDI Settings Menu. Default is CC#22
Sample Decay	CC	CC Number assignable in MIDI Settings Menu. Default is CC#75
Reverb Send	CC	CC Number assignable in MIDI Settings Menu. Default is CC#17
Delay Send	CC	CC Number assignable in MIDI Settings Menu. Default is CC#19
Overdrive	CC	CC Number assignable in MIDI Settings Menu. Default is CC#12
Bit Depth	CC	CC Number assignable in MIDI Settings Menu. Default is CC#13
Repeat Type	Repeat Type	Sets the number of repeats on the step.
Repeat Grid	Repeat Grid	Sets the density for the repeats on the step.
Chance	Chance	Determines the probability of occurring.
Action	Action	Sets the action to occur after a step trigger.
Randomize	Randomize	Strength of randomization applied.
Randomize Type	Randomize Type	What is affected by the randomize.
Move	Move	Moves steps across the grid in 1 step intervals.
Micromove	Micromove	Moves steps in micro intervals across the grid.

10 MIDI

10.7 Sequencing MIDI Notes.

NOTES

Sequencing MIDI steps follows the same basic principles as sequencing audio steps. As such the general process of sequencing patterns is not covered here and this section will concentrate on MIDI specific elements. MIDI tracks are polyphonic allowing multiple notes as chords to be transmitted out. MIDI Step notes can overlap, however the connected device may behave differently. This should be considered carefully.

Example: MIDI Output

4 Core Elements of a MIDI Note, MIDI Mode enabled.

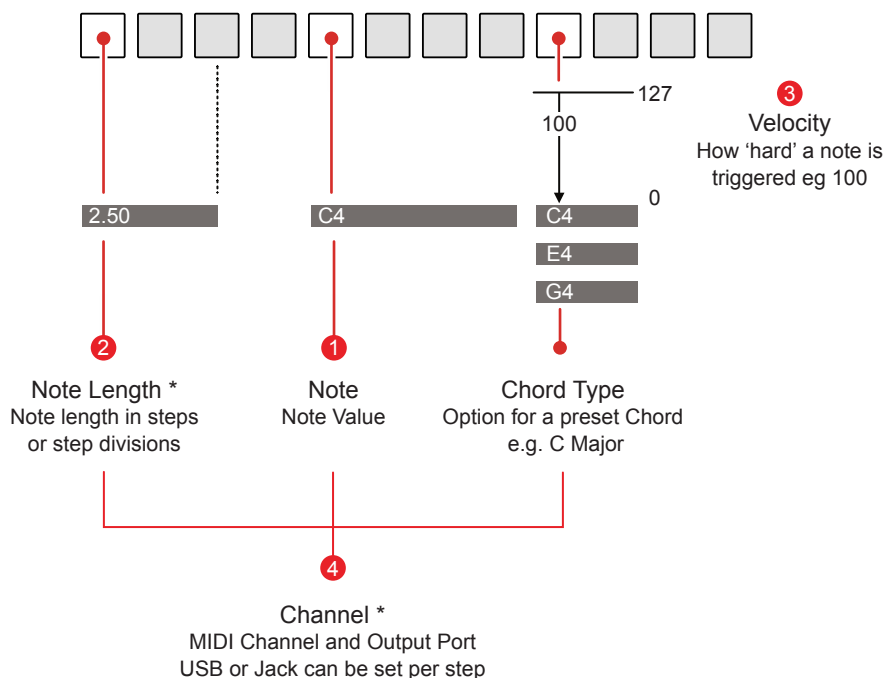

* Preview option when turning a knob does not operate for length and channel. Preview on knob turn does operate for Note, Velocity and Chord selection

MIDI Notes can be created as a work step and then populated into pattern or can be set on a per step basis. The MIDI Channel and the output port can even be set at a step level if required. When changing work step channel, the parameters are reset.

The Fill function can be used to populate work step settings across the selected tracks.

Randomize operates on Filter CC, Octave and Velocity when in MIDI Mode.

NOTES

When Play+ receives MIDI in it will use the work step for playback if a track or step is not selected. The Note however will be determined by MIDI input. Play+ operates with virtual MIDI thru functionality, redirecting out any incoming MIDI notes to the selected channel and port. In this situation length is ignored but chord and scale still apply

Example
Incoming MIDI.

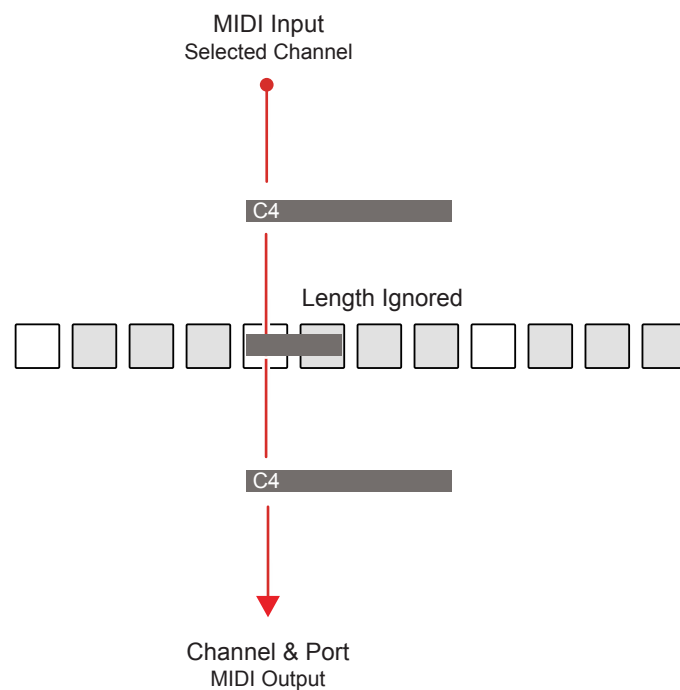

Recording MIDI Input

When recording MIDI in, multiple Audio or MIDI tracks will be used to record the chords and notes. Overdub recording in the main menu will overwrite existing notes present.

To record MIDI in, the destination tracks and 'Live Rec' will need to be selected. Play+ can be triggered by the external transport from the device is set up. The selected scale filter and scale will apply.

10 MIDI

10.8 MIDI Fill.

NOTES

Fills can automatically populate selected MIDI tracks with pre-defined patterns based on selected genres. This can be applied the same way as Audio fills where the Beat Fill applies Kick, Snare and HiHat patterns and the Melody Fill can apply chord and bass lines. This is especially useful for controlling other gear with quick and creative compositions. Ensure the correct connections and settings are applied for the MIDI set up used.

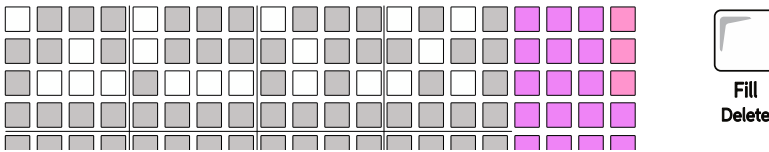

Fills can be applied to MIDI tracks in the same way as applied in Audio tracks. Select MIDI Mode and use the [Fill] command. Genre based templates will determine the pattern and notes.

As well as the defined notes for Kick, Snare and HiHats, the MIDI Output channel can be defined individually for these instruments plus the Chord and Bass instruments. These are all used with beat and melody fills.

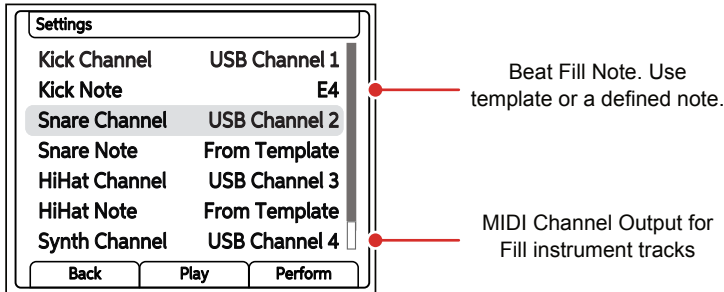

Example shows all Fill instruments with independent USB MIDI Channels.

DEFINING MIDI OUTPUT CHANNELS FOR FILL INSTRUMENTS

1. Press (Select) to open the main menu and Turn to highlight 'Settings'.
2. Press (Select) and navigate by turning to highlight 'Fill Config'. Press to select the sub menu.
3. The available options for Kick, Snare and HiHat allow the setting of the specific note to use when populating steps or from the template.
4. The available options for Kick, Snare, HiHat, Synth and Bass allows the setting of the independent MIDI channel for the Fill instrument output.

MIDI Fill application example.

Each instrument in a beat fill is configured to individual channels, each of which is connected to an appropriate instrument in Ableton Live. The fill generated in the MIDI tracks for the kick, snare and HiHat will then be communicated to the external MIDI instruments individually.

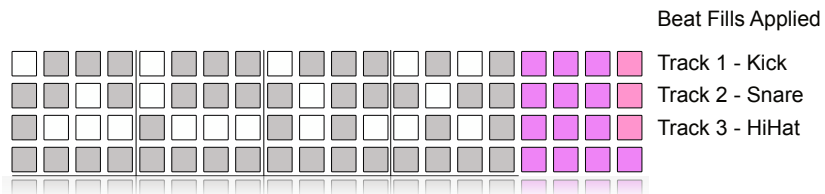

In the Settings > 'Fill Config' Options the Kick is set to USB Channel 1, Snare to USB Channel 2 and HiHat to USB Channel 3

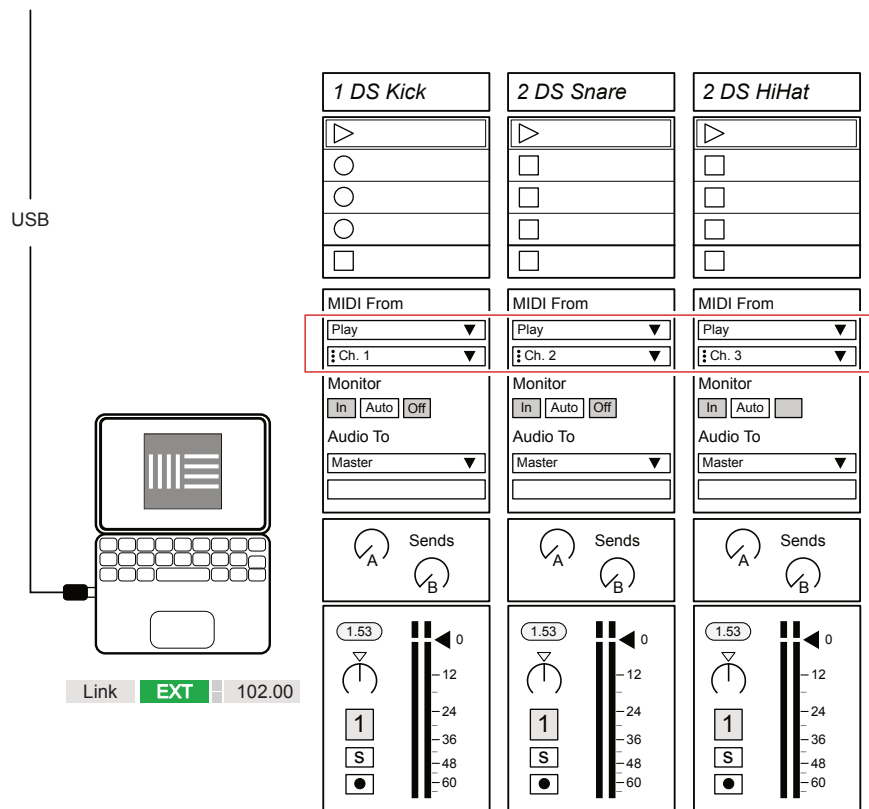

MIDI settings in the Live preferences page will need to be set 'On' for MIDI Ports, Input & Output. When controlling to/from Play+. The 'Ext' function, in Live should be on to use external sync settings and for tempo to be synchronised from Play+.

The configuration could equally use external hardware instruments as opposed to the DAW example shown.

10 MIDI

10.9 Chords & Scales.

NOTES

Chords can be applied in MIDI Mode. MIDI tracks are polyphonic and a number of chord presets are available to be selected that utilise the note setting as the root. Any scale filter set in the main menu will also be applied to existing patterns and MIDI Note output.

Scale Filter.

When filtered to a scale, the display will show when quantizing a note to one within the selected scale.

A#3 > B 3

Chord presets are selected using the chord type option found on the sample start knob when in MIDI Mode. The Note selected will form the root.

Chord Types

Turn (Sample Start). Examples shown use C as the root note.

Hold [Shift] + turn (Sample Start) to select a chord inversion from the selected chord type.

Power 4th



Power 5th



Major



Minor



Diminished

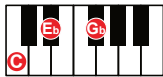

Augmented



Suspended2



Suspended4



Major 6th



Minor 6th



Major 7th



Minor 7th



Minor Major 7th



Dominant 7th



Major 9th



Minor 9th



Major 11th



Major 13th



Minor 11th



Minor 13th



Play+ has polyphonic tracks in MIDI Mode which allows chords to be applied from Play+ chord preset library, accessed with the 'Sample Start' knob. The chord will operate based on the scale set in the settings menu.

■ CREATING A MIDI CHORD SEQUENCE

1. Ensure the scale type is set as desired in the main menu. Press (Screen) to access the main menu and choose the 'Scales' sub-menu. To cover all the chord options use chromatic.
2. A work step can be set for the root note and chords but it is better to use per step editing for these. The work step however is a good option to set for a generic MIDI Channel and Port.
3. Live recording allows real-time recording of MIDI notes. Use the View keyboard to play in and record steps to selected tracks.
4. For per step editing, keep the step [Pad] held in the following instructions:-
 - Hold [Pad] + Turn (Sample) to set the MIDI Channel and Port if a per step setting is required for these options.
 - Hold [Pad] + Turn (Note) to assign the root note. Example 'C'
 - Hold [Pad] + Turn (Sample Start) to assign a chord type from the chord library. These are predetermined chords. If a chord contains notes not in the active scale type, a [-] symbol will be displayed alongside the chord name. The chord will still be transmitted.
 - Other parameters such as note length and velocity can also be set if required per step or as a work step.
5. Repeat the instructions in step 3 to build melodic progressions across the tracks.

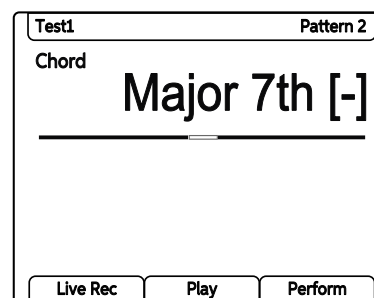

10 MIDI

10.10 CC Messages.

NOTES

MIDI Continuous Control Change Messages, also shortened to CC, are available in Play+. CC Messages allow parameter changes to be communicated with a value range of 0-127. A pattern steps can be programmed from the CC parameter with a value for the step. Manual knob control and note preview output is based on the preview setting.

Example

Sequencing CC Messages. External Filter Cutoff

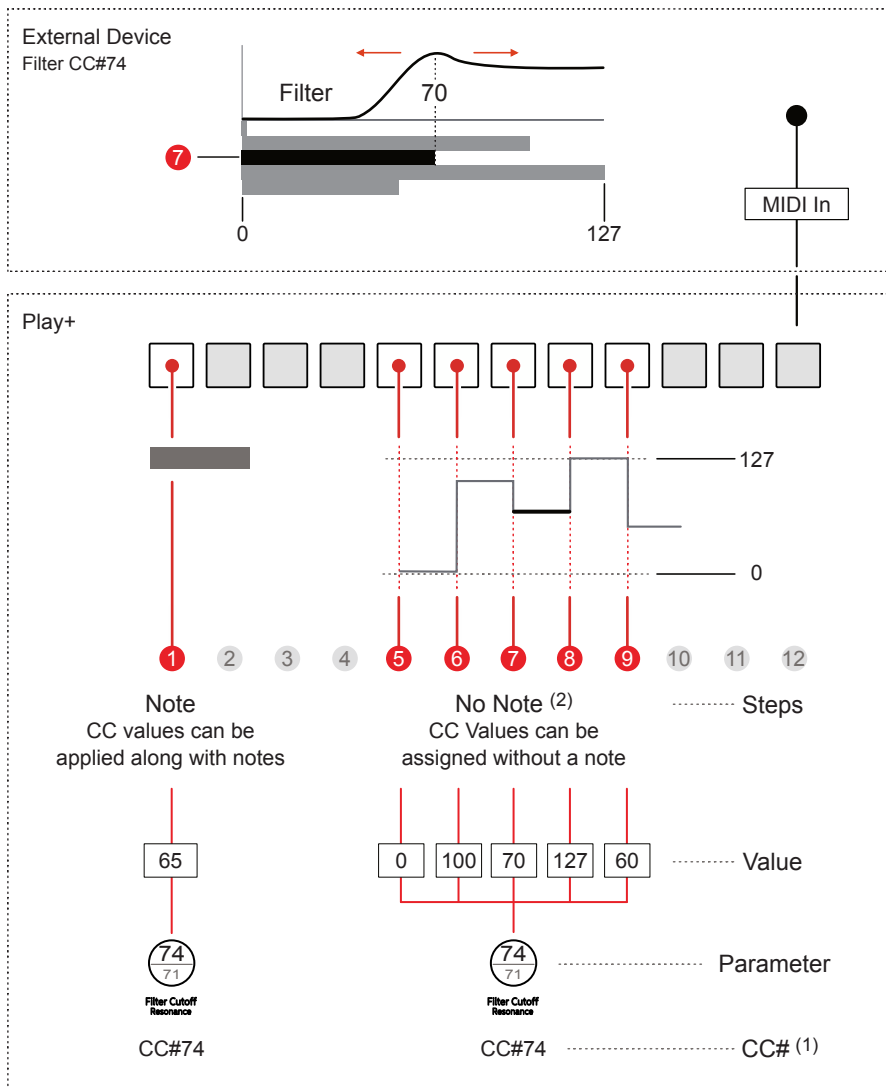

Manual adjustment of CC messages is sent out only when sequencer is stopped as part of the preview. Sequenced CC steps transmit when the pattern plays.

(1) CC Number assignment is made in the Main Menu 'MIDI' configuration menu under the 'CC Mapping' options. Default is shown in the example illustration.

(2) A 'No Note' function is selectable within the 'Note' Parameter options.

A pattern can be programmed with CC change values per step. This allows automation of defined parameters on a connected external device. CC messages are not muted when using the [Mute] Buttons.

■ CREATING A MIDI CC SEQUENCE

1. Establish what the MIDI CC configuration is for the devices to connect to Play+. Most device manufacturers provide documented CC settings for their gear. These are also called 'MIDI definitions' in the standard documentation. Ensure this is the device CC definitions and not NRPN which are not compatible with Play+.
2. The default MIDI Control parameters are assigned to Knobs for CC#'s 12, 13, 17, 19, 22, 71, 74 and 75. These can be changed in the MIDI Menu under 'CC Mapping, described later.
3. The objective is to set values for a CC# that matches the destination parameter to control. For example, CC#75 for a Digitakt connected device is Filter Resonance. Therefore the default Play+ configuration uses (Sample Decay) Knob to control CC#75.
4. In MIDI Mode and with the sequencer stopped, turning a MIDI CC knob on Play+ will send a real time CC message.
5. In Live Rec mode, realtime changes to CC parameters will be recorded into selected tracks. Only active steps i.e. with a musical note or a 'no note', note assigned will record a CC value.
6. To program a CC pattern and create an automation lane per step, Hold step [Pad] + Turn (Knob) for the CC parameter to adjust. In MIDI Mode, several parameter knobs revert to CC control knobs. The values set will transmit to the external device over a 0-127 range.
7. To remove a CC setting on a step, Hold the step to edit [Pad] + Quickly Double Tap the Left side [Screen Button] for the parameter in focus. This will reset the selected parameter to it's default value.

10 MIDI

10.11 CC Mapping.

NOTES

Four of the parameter knobs are defined as MIDI CC control knobs when in MIDI Mode covering eight parameters. A set of CC numbers are assigned to the knobs by default. These are assigned per port, Jack or USB and per Channel, 1-16. This means a new set of parameters will apply to different channels or between the USB and MIDI Jack if required. The CC mappings can be edited in the Main Menu MIDI options.

Filter Cutoff, Resonance, Sample Attack, Sample Decay, Reverb Send, Delay Send, Overdrive and Bit Depth are all reassigned to MIDI CC Parameter controls when in MIDI Mode. Assignment can be changed in the MIDI menu.

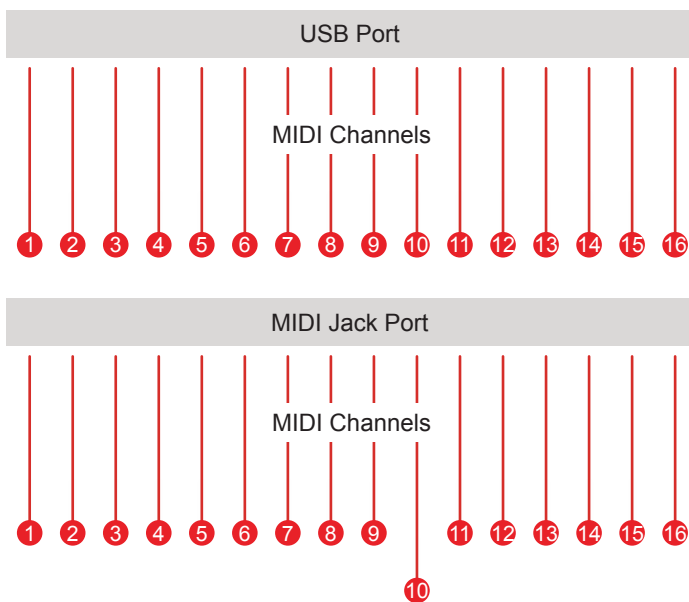
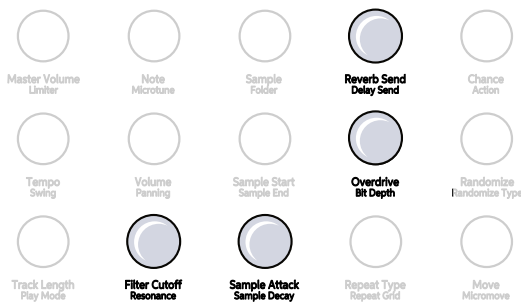

CC Mapping can be made independently for each port and each channel

... Mapping > Jack Channel 10	
CC Cutoff	74
CC Resonance	71
CC Sample Attack	22
CC Sample Decay	75
CC Reverb Send	17
CC Delay Send	19
CC Overdrive	12

The main menu MIDI options allow CC Mapping per Port and Per Channel. This is how Play+ aligns its CC parameters to an external device's default CC target parameters. Note that when connecting Polyend Tracker, a predefined preset to control its parameters is also available, selectable in the Play+ MIDI CC Settings.

■ CHANGING THE CC MAPPING

1. Refer to the destination devices MIDI definitions. Ensure this is the device CC definitions and not NRPN as these are not compatible with Play+. The destination target parameters should be identified.
2. The default MIDI Control parameters are assigned to Knobs for CC#'s 12, 13, 17, 19, 22, 71, 74 and 75. These can be changed.
3. Press (Screen) to open the main configuration menu. Turn the (Screen) knob to navigate to highlight 'MIDI'. Press (Screen) to open the MIDI sub-menu. If the menu is not at the main menu, press [Back] to backup.
4. Turn the (Screen) knob to navigate to highlight 'CC Mapping'. Press (Screen) to open the CC Mapping sub-menu.
5. Turn the (Screen) knob to navigate to highlight the MIDI output port and channel to configure the CC's. The Jack refers to the MIDI out connected with the 5-Pin DIN Adaptor and USB refers to the same connection as power. Press (Screen) to open the Port /Channel mapping page.
6. The 8 CC Parameter configurations, represented by the 4 physical knobs are listed. In addition the option to set the mapping to match Polyend Tracker is also listed.
7. Turn (Screen) to highlight the knob parameter to change and Press (Screen) to select it for editing.
8. The CC# list is presented. Turn (Screen) to highlight the CC# that represents the destination parameter to assign. Press (Screen) to select the highlighted number.
9. Continue by iterating through the steps 7-8 to edit other controls if required.

MIDI CC can be transmitted manually, this is ideal to enable mapping between the Play+ MIDI CC Sources and a destination device. Many third party devices have a 'MIDI Learn' option which, when selected, detects and automatically maps incoming MIDI CC to the selected parameters.

MANUALLY TRANSMITTING MIDI CC MESSAGES

1. Refer to the destination devices MIDI definitions. If MIDI Learn is available this can be used to detect and map incoming MIDI CC Messages automatically.
2. Ensure the sequencer is stopped. MIDI CC messages are not transmitted when manually turning knobs when the sequencer is playing. Only sequenced CC steps are transmitted when playing.
3. Select MIDI Mode by pressing [Shift] + [Audio/MIDI]. The function buttons will be lit purple.
4. Turn (Sample) to select the MIDI Channel and Port connected to the external device.
5. Tap (Note) to select the note parameter. This must be set to 'No Note' in order to only transmit CC messages. If a note value is selected this note will be transmitted along with the CC when turning a knob to preview the sound. This will disrupt the MIDI Learn function of the destination device but may be useful when a note preview of the destination changes is needed. Turn (Note) to select 'No Note'.
6. The 8 CC Parameter configurations are represented by 4 physical knobs. These will transmit MIDI CC when turned and when the sequencer is stopped from playing. These have default CC settings but this assignment can be changed in the CC mapping option.
7. A connected destination device on the same port and channel will receive the MIDI Messages. If MIDI Learn is available this will allow incoming MIDI to be detected and mapped to the external device parameters. If no MIDI learn is available the CC values will have to be mapped in Play+ manually to match the device parameters.

10.12 Program Change.

Play+ has the ability to send Program Change messages, also called PC Messages. PC Messages trigger a change to a patch, program, bank or preset on the destination device. The behaviour of the destination unit will vary between devices as this relies heavily on the functional design of each individual device. Program Change messages are controlled by the (Folder) knob, the secondary option to sample parameter and cannot be muted.

The 'Folder' parameter knob is reassigned to the 'Program' parameter for PC messaging. The value range to transmit is between 0-127 and its interpretation will depend on the destination device. The PC message is transmitted in real-time when the knob is turned in MIDI Mode when the sequencer is stopped.

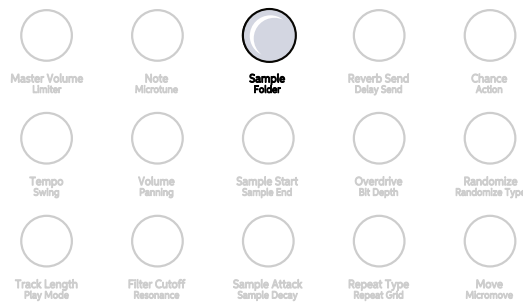

Example Sequencing PC Messages.

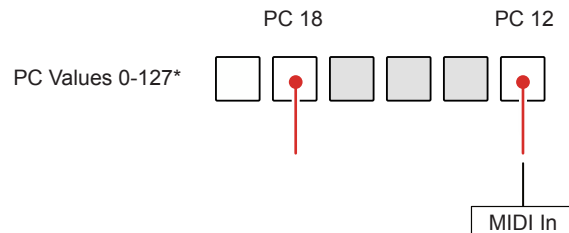

External Device
 Example of different preset / patch structures 12 = A13, 18 = B3 i.e. 18=15+3, Play+ Starts at 0*.

Bank A	Bank B	Bank C	Bank D
1 2 3 4	1 2 3 4	1 2 3 4	1 2 3 4
5 6 7 8	5 6 7 8	5 6 7 8	5 6 7 8
9 10 11 12	9 10 11 12	9 10 11 12	9 10 11 12
13 14 15 16	13 14 15 16	13 14 15 16	13 14 15 16
0-15*	16-31*	32-47*	48-63*

PC messages can be applied to steps the same way as applying CC values. Manual transmission of MIDI PC Knob, as with CC is suspended when the sequencer is running. The external device may be completely different configuration of patches than the simple 0-127 messages transmitted from Play+. Trial and error may be needed to establish the destination structure alignment.

The destination device behaviour is an important consideration when transmitting MIDI PC messages. As well as the structural alignment of the programs / presets the following topics may need some thought to achieve the desired results:-

- As with MIDI CC, the PC Messages can be also transmitted manually by turning the (Folder) Knob. The sequencer must be stopped for the message to be transmitted. The behaviour at the destination may vary per device and some may also require the transport playback to be stopped.
- PC messages are sent per MIDI Channel.
- PC messages can be applied to steps the same way as applying CC values. How these are received may depend on the destination device. Some may change presets others patterns, some may change real-time in line with Play+ sequencer, some may wait to a restarted pattern for example.
- The external device may be completely different in the configuration of patches than the simple 0-127 messages transmitted from Play+. Trial and error may be needed to establish the destination structure alignment.
- The changes applied at the destination are often with respect to the currently selected patch or bank rather than an absolute selection.

10.13 Pitch Bend.

Pitch bend is a common and fairly standard part of a synthesizer or keyboard and follows a similar set up across many devices. Pitch bend is part of the MIDI standards. Play+ uses the (Microtune) parameter knob to control pitch bend when in MIDI Mode.

Pitch bend can be sequenced on note steps or use 'No Note' steps to create a sequence of pitch bend changes in a pattern. Manual control of pitch bend is possible when the sequencer is stopped. Stopping the sequencer resets any pitch bend values to 0.

Pitch bend operates -100 to +100. The convention for pitch bend is to operate in a bi-polar way. Pitch bend will use the 'Microtune' option when in MIDI Mode.

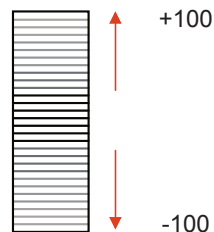
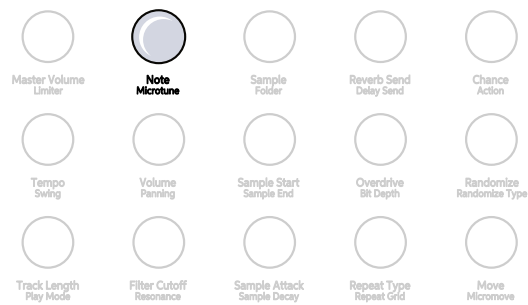

Traditional Pitch bend uses a dedicated wheel to manually adjust the pitch while playing. Play+ can adjust values within the programmed sequence.

10 MIDI

10.14 Tracker MIDI Integration.

NOTES

Play+ integrates seamlessly with Polyend Tracker. The option to set CC values for Tracker is also available in Play+ MIDI CC Port / Channel configuration. Tracker operates in MIDI synthesizer mode that allows integration when controlling Tracker from an external MIDI device and by controlling up to 8 voices across MIDI. Trackers selected instrument will act as the sound source and it is this instruments parameters that the Play+ CC will control. Play+ is the primary lead, handling control and clock while Tracker is the secondary follower.

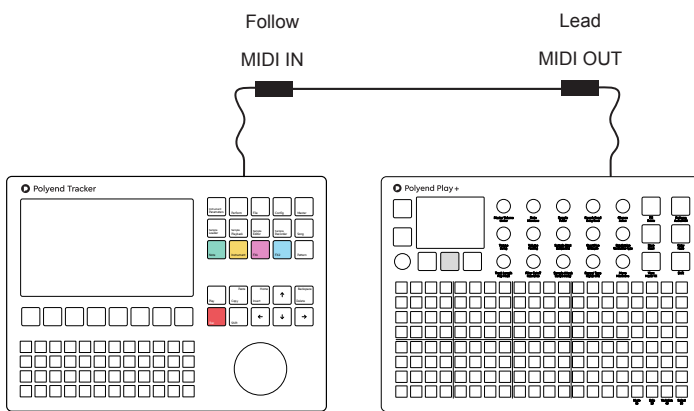

Tracker:

Config > MIDI

Clock In	MIDI In jack
Clock out	Off
Transport in	MIDI In jack
Transport out	Off
Notes In	MIDI In jack
Notes in channel	CH1
MIDI out	Off
CC in	MIDI In jack
CC in channel	CH1
Middle C	C-5
Clock sync delay	0.0

Play+:

Menu > MIDI > CC Mapping > Jack Channel 1

Choose: Set Values for Polyend Tracker

The rotary controls in the connected Play+ device will be automatically mapped to have full integrated over MIDI CC with Tracker's selected instruments. Play+ can control Tracker with its grid pads.

... Mapping > Jack Channel 1	
CC Cutoff	1
CC Resonance	11
CC Sample Attack	104
CC Sample Decay	107
CC Reverb Send	14
CC Delay Send	15
CC Overdrive	12

Back Play

Trackers CC's are automatically mapped when triggering the 'Set Value for Polyend Tracker' option in the MIDI CC configurations. The CC#'s are mapped to the Filter Cutoff / Resonance, Sample Attack / Sample Decay, Reverb Send / Delay Send, Overdrive / Bit Depth. The display will indicate the CC#.

SETTING THE TRACKER CC MAPPING

1. Connect Play+ as the primary lead and Tracker as the secondary follower using the MIDI Jack adapters or via a USB Hub.
2. The default MIDI Control parameters are assigned to Knobs for CC#'s 12, 13, 17, 19, 22, 71, 74 and 75. These can be changed in batch for Tracker integration.
3. Press (Screen) to open the main configuration menu. Turn the (Screen) knob to navigate to highlight 'MIDI'. Press (Screen) to open the MIDI sub-menu. If the menu is not at the main menu, press [Back] to backup.
4. Turn the (Screen) knob to navigate to highlight 'CC Mapping'. Press (Screen) to open the CC Mapping sub-menu.
5. Turn the (Screen) knob to navigate to highlight the MIDI output port and channel which connects the Tracker. The Jack refers to the MIDI out connected with the 5-Pin DIN Adaptor and USB refers to the same connection as power. Press (Screen) to open the Port /Channel mapping page.
6. The 8 CC Parameter configurations and an option for Polyend Tracker is also listed. Turn (Screen) to highlight 'Set value for Polyend Tracker'
7. Press (Screen) to select and automatically configure the CC#'s to match the Play+ knobs with the Tracker functions. Play+ will lead and Tracker follow the CC values.

Play+ Knob	MIDI Mode	Tracker Destination
Filter Cutoff	CC 1	Filter Cutoff
Resonance	CC 11	Resonance
Sample Attack	CC 104	Wavetable Position - LFO Speed
Sample Decay	CC 107	Wavetable Position - LFO Amount
Reverb Send	CC 14	Reverb Send
Delay Send	CC 15	Delay Send
Overdrive	CC 12	Overdrive
Bit Depth	CC 13	Bit Depth

Trackers MIDI settings will also need to be configured to receive MIDI messages and clock from Play+.

11

System

While on face value this section may appear like the boring bit (I guess in many ways that could be true), don't overlook the content. There are some elements that at least are useful to be aware of. Play+ has the ability to deliver audio over USB for example to interface to a PC or Mac Digital Audio Workstation. There are also some useful tips and advice that may help if you are in a sticky situation, details of main menu options, microSD card details and system specifications. Also there are some topics that might be useful around housekeeping and good disciplines in working with Play+. But there are also some tips that may be helpful beyond the administrative duties. The visual style pad brightness can be adjusted and options for behavioural elements such as knob functions can be changed based on personal taste. Of course the general firmware update options are covered in this section, although it

is recommended to always follow Polyend's guidelines and instructions with each firmware release as it is possible that these may change per update. The active firmware version is displayed on start up screen and also in the firmware option of the main menu settings. Registration of the device is required to access downloadable content and firmware updates. Registration is performed at [Polyend.com](https://polyend.com). This section not only covers system wide features and firmware update details, but also is a catch all for topics not covered elsewhere in this manual.

11 System

11.1 Audio Output Over USB.

NOTES

Play+ can send audio out over a connected USB connection. This will send 28 channels of mono audio or 14 stereo channels out to the connected device. The configuration is automatic within the Play+ and any compatible device connected to the USB connection will be able to access the audio channels from Play+.

USB Audio is designed for recording completed songs. Composing, and sound design over USB can cause audio playback issues. Scrolling synth patches during audio playback via USB is not recommended. Loading projects while USB audio is engaged can also cause connection issues.

Channel	Outputs	Command
1	1 & 2	Master Output
2	3 & 4	Track 1 Stereo Audio Output
3	5 & 6	Track 2 Stereo Audio Output
4	7 & 8	Track 3 Stereo Audio Output
5	9 & 10	Track 4 Stereo Audio Output
6	11 & 12	Track 5 Stereo Audio Output
7	13 & 14	Track 6 Stereo Audio Output
8	15 & 16	Track 7 Stereo Audio Output
9	17 & 18	Track 8 Stereo Audio Output
10	19 & 20	Synth Tracks Stereo Output
11	21 & 22	Reserved
12	23 & 24	Reserved
13	25 & 26	Delay Stereo Audio Output
14	27 & 28	Reverb Stereo Audio Output

Important Notes for USB Audio & MIDI Requirements and Troubleshooting

- Audio over USB on the Polyend Play+ is only supported on the latest operating systems for Mac and Windows PC. Phones and older operating systems are not supported and may not be compatible. Make sure your computer OS and relevant drivers are up to date.
- USB hubs are not supported. Connect Play+ directly to your computer.
- Make sure your USB cable is capable of data transfer, some USB cables are created for charging only.
- To make sure Play+ is correctly recognized as an audio device by your computer OS and DAW follow, in the defined order, these few steps:
 1. Connect the USB cable while your Play+ is switched off.
 2. Once the USB cable is connected to the devices, power on Play+
 3. Launch the DAW on the Mac/PC.
 4. Select Play+ as your audio input and output device.
- If you are still experiencing issues then we suggest trying the following:
 - Change to another buffer size setting.
 - Create an aggregate device to use a different audio output device simultaneously with Play+ as your input device. Aggregate device setting especially helps with buffer underruns which result in buzzing / frozen loop at the output and can happen in certain configurations during operations like switching synth patches while playback is running
 - Double check USB sockets, if multiple sockets are available please try all sockets.

Aggregate Device

To ensure compatibility with the USB Audio features of Play+ it is highly recommended to use a Mac or PC set up with an aggregate device. An aggregate device is a virtual interface created on the PC or Mac to integrate several audio in and out elements together. This overcomes any issues with multiple / separate devices used for inputs and outputs to a PC or Mac and allows audio software such as a DAW to connect seamlessly.

■ CREATING AN AGGREGATE DEVICE - MAC

1. Ensure Play+ is connected to the Mac via the USB connection.
2. Select and open the 'Finder' function on the Mac.
3. With the finder page open and selected, choose from the main header menu 'Go' > 'Utilities'.
4. Double click on the 'Audio MIDI Setup' icon from within the presented utility options page.
5. The audio device page will open. This should show all connected devices in the left window pane and will include the Play+ as well as the Mac's integrated speakers and microphone.
6. Click '+' in the lower left corner and choose 'create aggregate device'.
7. A new device is created and the selection boxes will be presented. Check the boxes of the devices to add to the aggregated device. For example Play+ and Speakers.
8. Click the name in the left window to rename the device if required.
9. Once the device has been created this will appear in a DAW's audio interface options, for example 'Audio input' and 'Audio output' options in Ableton Live Audio settings.
10. This aggregated device should be the chosen option to interface the Play+ to the Mac Audio. This will handle all the available inputs from Play+ as well as the audio outputs on the Mac for example output audio to the internal speakers.

CREATING AN AGGREGATE DEVICE - PC

1. A PC has no native options to aggregate devices. It is recommended to use an up to date audio compatible driver on the PC. The ASIO4ALL driver is a commonly used 3rd party option with PC's for audio applications. The guide below assumes using ASIO4ALL.
2. Ensure Play+ is connected to the PC via the USB connection.
3. Ensure the ASIO4ALL driver is selected in your chosen DAW as the audio interface and open the driver to set up the options.
4. In the ASIO4ALL window the left window pane should show all the available input and output devices.
5. Check the devices to integrate together. There may also be options to aggregate only specific inputs rather than an entire device. This is usually available when ASIO4ALL is not in 'simple view' mode.
6. Once the devices have been selected the associated inputs will appear in a DAW's audio interface options, for example 'Audio input' and 'Audio output' options in Ableton Live Audio settings. Remember that the ASIO4ALL must be the driver selected.
7. This aggregated device should be the chosen option to interface the Play+ to the Mac Audio. This will handle all the available inputs from Play+ as well as the aggregated audio I/O functions.

11 System

The ability to connect audio via USB is possible. An example is when using a PC or Mac via USB which hosts a compatible application, for example Ableton Live DAW. It is recommended to connect directly between devices as Play+ does not support USB hubs.

Example Configuration: Play+ out to Ableton Live.

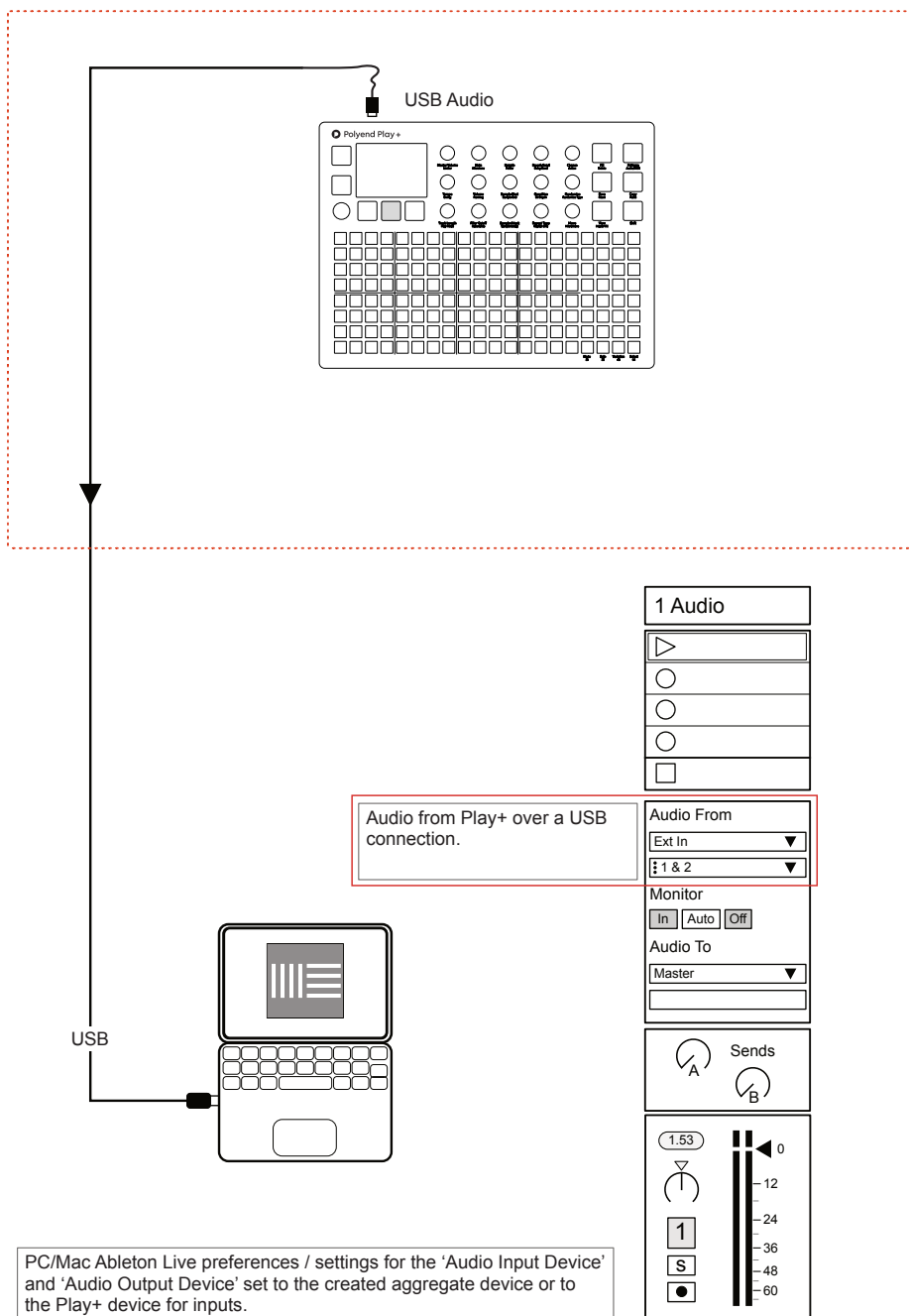

11.2 Device Registration.

In order for Polyend to provide device support and to give access to future firmware updates, your Play+ must be registered on the Polyend website.

■ REGISTRATION / SUPPORT CHECKLIST

- Create an account at [Polyend.com](https://polyend.com).
- Register your device, ie Play+ in the relevant account section.
- Access firmware downloads in your account.
- Licence information is available at polyend.com/licenses/

11 System

11.3 Generic Firmware Update

NOTES

Firmware updates may be provided by Polyend from time to time, to fix bugs or add new features. The process of updating can be performed in several ways. When performing updates it is strongly advised to follow the Polyend instructions supplied with each update. The instructions here are a generic guide only. Ensure your device is registered with Polyend.

FIRMWARE UPDATE

1. Download the latest firmware. Access firmware updates for your device from your registered account at Polyend.
2. Copy the downloaded .ppf firmware file into the /Firmware folder. This can be found in the root directory of the microSD card.
3. Insert the microSD card into Play+ and power up.
4. Press (Screen) knob to open the configuration and settings menu.
5. Navigate through the 'Settings' and 'Firmware' menus. Open the 'Firmware Update' function, highlight the firmware version to install.
6. Press (Screen), knob to select firmware.
7. The screen will prompt "yes" or "No" to confirm using the left screen buttons. To continue press [Yes].
8. The firmware will install and the on screen prompts provided will guide. The install process is typically less than 1 minute.
9. Play+ should restart automatically. If not and only when the update is 100% completed, Press On/Off to perform a manual start.

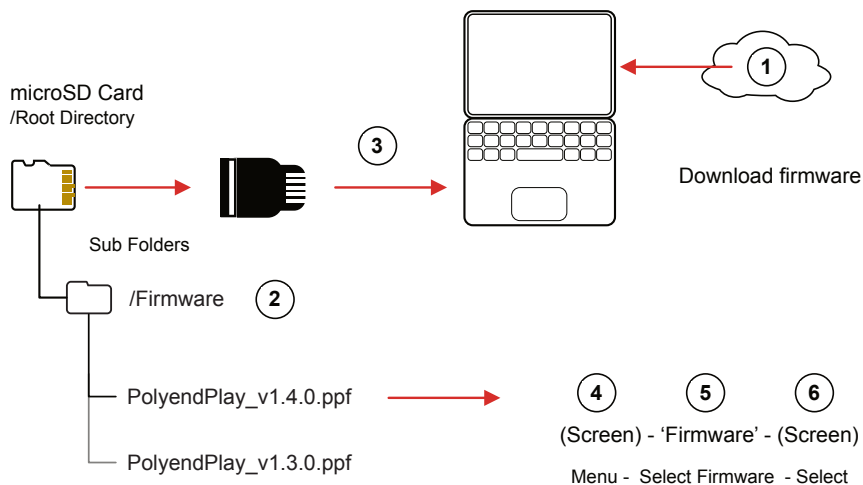

11.4 Emergency Firmware Update.

Firmware updates are available from the Polyend portal for your registered device. A reset button is provided, recessed behind the rear panel for emergency situations. A reset can be performed if there are issues with the update method or to clear Play+ issues but should not be used as a regular process for updates.

PLAY+ AND FIRMWARE RESET

1. Download the latest firmware. Access firmware updates for your device from your registered account at Polyend.
2. Copy the downloaded .ppf firmware file into the /Firmware folder. This can be found in the root directory of the microSD card. Also ensure any previous update files remain in the firmware folder.
3. Insert the microSD card into Play+.
4. Use a pin or thin object to press the internal reset button. This is located on the rear of the device behind the case next to the USB connection.
5. Play+ will reset and search the firmware folder on the microSD card. A random firmware will be selected and installed in order to recover Play+ to a working state. The install process is typically less than 1 minute.

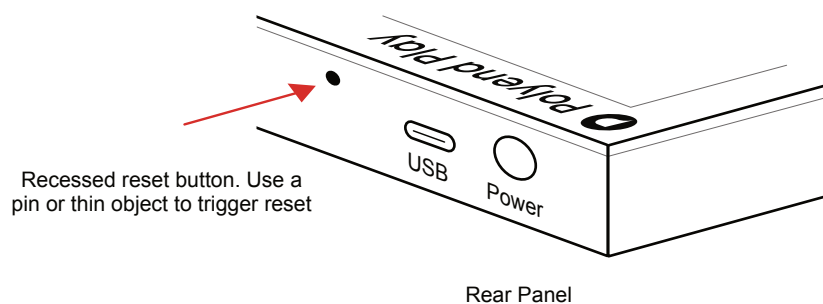

The reset option is useful if any lock ups or freezing occurs on Play+. It is not necessary in these situations to download a new OS. It is advised to keep a series of official, known good, firmware releases in the /firmware folder. For example 1.2.0, 1.3.0, 1.4.0. That way steps 4-5 can be performed in case of issues and a random update will be performed from a known state. A manual update in the main menu to select the latest version can then follow. If problems persist, try updating after removing the 'workspace' folder from the microSD card.

11 System

11.5 User Interface Style.

NOTES

A number of user preferences that affect the style of Play+ are configurable in the main menu settings, accessed by pressing the (Screen) knob. These include grid pad brightness and knob behaviour for double tap or preview.

■ CHANGING GRID BRIGHTNESS

1. Press (Screen) Knob to open the main menu.
2. Navigate using the screen knob to the 'Settings' menu option. Press (Screen) to select and open this menu.
3. Navigate using the screen knob to the 'Grid Brightness' option. Press (Screen) to select and open the options.
4. The grid brightness options are listed; High, Medium or Low.
5. Navigate using the screen knob to the option desired. High is default. Press (Screen) to select desired option.
6. The changes will be visible on any of the 20x8 selected and lit pads.
7. Press [Back] to backup and exit the menu option. Selecting a parameter knob will also leave the menu.

■ CHANGING THE DOUBLE TAP KNOB BEHAVIOUR

1. Press (Screen) Knob to open the main menu.
2. Navigate using the screen knob to the 'Settings' menu option. Press (Screen) to select and open this menu.
3. Navigate to the 'Knob Double Tap' option by turning (Screen). Press (Screen) to select and open the options.
4. The double tap options are listed; Yes or No.
 - Yes will allow double tapping of a parameter knob to switch between the two parameters. This is standard default behaviour.
 - No will not use double tap option on the parameter knobs. The left [Screen] buttons can still switch between parameters on each knob.
5. Press [Back] to backup and exit the menu option. Selecting a parameter knob will also leave the menu.

CHANGING THE KNOB PREVIEW BEHAVIOUR

1. Press (Screen) Knob to open the main menu.
2. Navigate using the screen knob to the 'Settings' menu option. Press (Screen) to select and open this menu.
3. Navigate to the 'Knob Preview' option by turning (Screen). Press (Screen) to select and open the options.
4. The preview options are listed; Off, Stopped, Playback or Stopped & Playback. These select how the audio preview is applied when manually turning a knob and selecting a parameter value.
 - Off: Will not preview any audio with the parameter value when adjusting a parameter knob.
 - Stopped: Will only preview the audio for parameter value change when adjusting a knob when the sequencer is stopped. When playing no preview is audible. Default.
 - Playback: Will only preview the audio for parameter value change when adjusting a knob when the sequencer is playing. When playing is stopped no preview is audible.
 - Playback & Stopped: Will preview the audio for parameter value change when adjusting a knob when the sequencer is playing or when it is stopped.
5. Press [Back] to backup and exit the menu option. Selecting a parameter knob will also leave the menu.

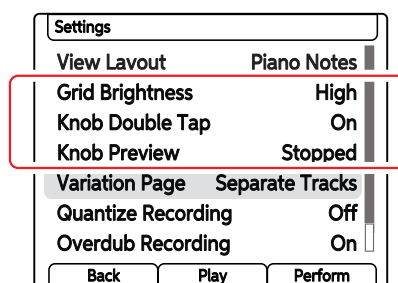

11 System

11.6 SD Card Compatibility & Backing Up.

NOTES

It is always good practice to backup or even better have a spare microSD Card loaded and ready for use with Play+. The following information on microSD compatibility is important:-

- A 16GB SD microSD card is supplied with Play+. Larger size microSD cards can also be used. Supplied microSD Card is: Sandisk Ultra, Micro SD, 16GB, HC1 A1.
- The format of the card must be FAT32 MBR (Master Boot Record). Other formats will not be recognised.
- Play+ uses the microSD card in real time and will not function without the microSD card being installed. A 'bad' folder / file structure on the microSD card may also cause Play+ problems.
- It is good practice to create a duplicate copy of the microSD card for backup purposes. Also if Play+ does not boot up and crashes, restoring the full original folder / files structure or using the backup microSD card is advised.
- Play+ is supplied with an microSD card USB Type A reader for use with most Mac / PC's which helps transfer files.
- Polyend typically provide pre-release firmware as open beta. While this is great to get early insights into new features, by definition beta releases will have inherent problems. Only use beta versions to help test for bugs and features and do not use in a live gig or critical production environment.

Tip: The microSD cards can be notorious in there levels of performance with various gear. This is mainly due to the wide variety of speeds and specifications available. Gear producers do not and in fact cannot test every single SD specification or each of the manufacturers products. It is therefore recommended to stick as close as possible to the same microSD card type that the gear producer supplies with its gear. At least it is known that this microSD card type will then have been tested thoroughly with the device itself by the device manufacturer as well as the user community.

BACKING UP THE CARD FOLDERS & FILES

1. This is recommended as a first task when first operating Play+ in order to have the original structure saved. Also periodic backups is important to save the projects and files which will be created over time.
2. Use a compatible microSD card reader or the supplied USB microSD adapter to connect the microSD card to a PC or Mac.
3. Use the file manager (depends on the PC/Mac Operating System) to create a 'Play+ Backup' Folder in your documents folder and create a sub folder for each backup i.e. 'Original SD Aug21', 'Backup1 SD May22'. It is good practice to name backup folders by date.
4. Select all of the folders in the microSD card root directory and copy them to the PC/Mac clipboard.
5. Paste, the copied folders into the 'Play+ Backup' sub-folder for the specific backup.
6. Return the microSD card to Play+ for normal operation.

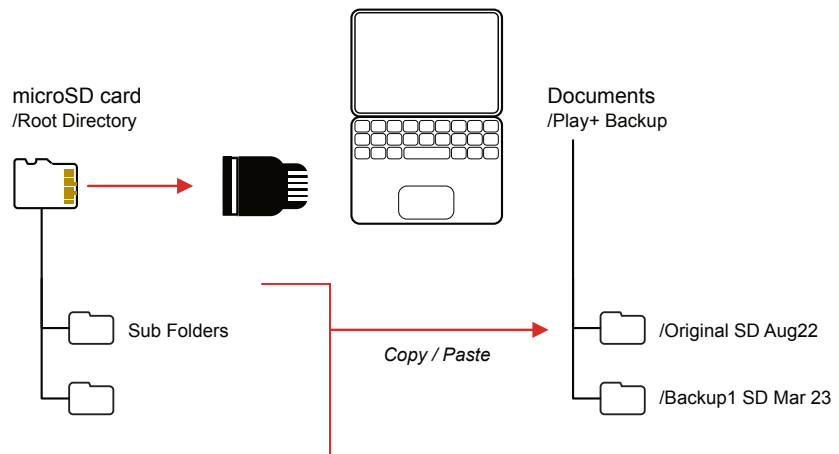

11 System

11.7 USB Storage Access

NOTES

The microSD card can be extracted and used in a Mac or PC for file transfers. In addition, Play+ allows direct access to the microSD card while inserted on board the Play+ Device using a USB connection. This is set in the Config menu options.

■ ACCESSING THE CARD STORAGE OVER USB.

1. Ensure the PC / Mac is connected to the Play+ with a USB data cable. Ensure the cable is data compatible and not just a power supply USB cable. It is recommended to connect directly between Play+ and the PC / Mac so ensure the Play+ can also be powered from the PC / Mac.
2. Ensure the Play+ has the microSD card inserted and is powered on.
3. Press (Screen) for the configuration settings.
4. Turn (Screen) to navigate to the 'Settings' menu. Press to open the sub-menu options.
5. Turn (Screen) to navigate to the 'Enter USB Storage Mode' option. Press (Screen) to switch Play+ into mass storage mode.
6. The PC or Mac file browsers will see the Play+ as an external device. This allows files, packs or samples to be transferred and data to be backed up to / from the microSD card.
7. To exit this mode, Press [Exit] screen button. The Play+ will switch back to normal operating mode. It is also recommended to eject Play+ on the computer. Do not unplug the cable while this mode is active.

NOTES

USB Storage

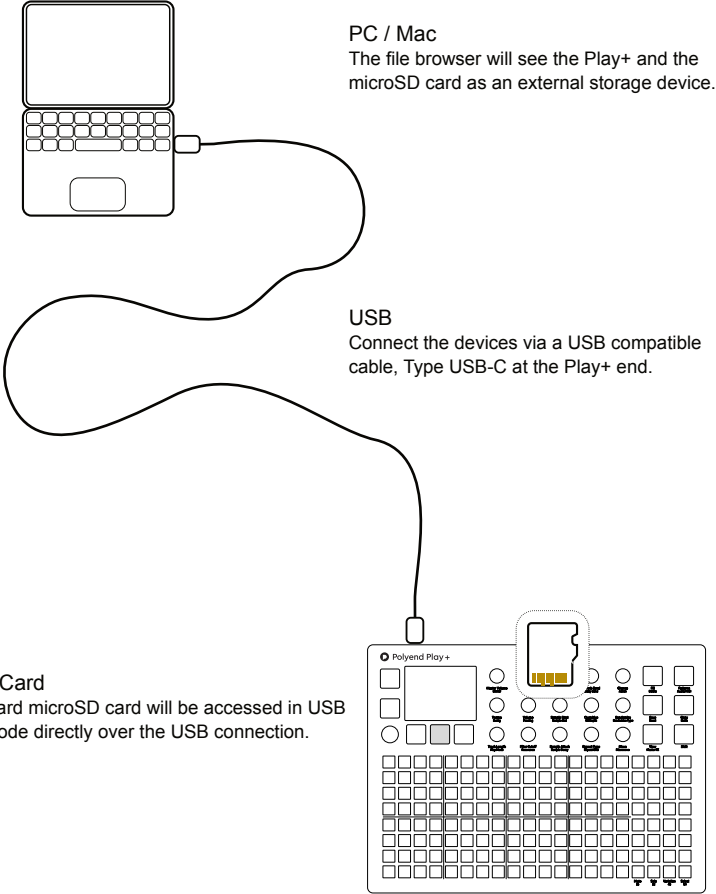

PC / Mac
 The file browser will see the Play+ and the microSD card as an external storage device.

USB
 Connect the devices via a USB compatible cable, Type USB-C at the Play+ end.

microSD Card
 The on-board microSD card will be accessed in USB Storage mode directly over the USB connection.

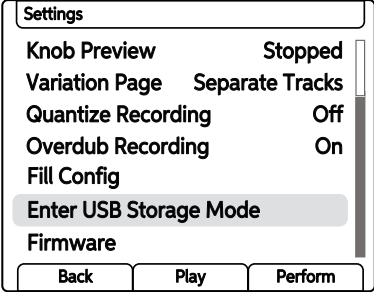

11 System

11.8 Official Specifications.

NOTES

Audio Output

- Line Output:
 - Output level 9 dBu peak (when 10k Ohm Load).
 - Signal to Noise Ratio: 97 dB.
- Headphone Output:
 - Output level: 17.6 dB (when 16k Ohm Load)
 - Signal to Noise Ratio: 98 dB.
- Power Supply:
 - 5V / 1A Supply via USB-C

Whats in the Box?

- Original USB A power adapter (with different standard plugs set).
Branded USB-C cable (2 m).
- 1x Stereo 3.5 mm jack to 2x 6.3 mm jack adapter.
- 1x MIDI Type B, 3.5 mm jack to DIN adapter.
- 16GB microSD Card.
- microSD to USB-A dongle adapter.
- Warranty & Safety and Polyend Play+ Essential information brochures

11.9 Changelog

OS & Manual	Feature Update	Manual Update
1.2.0 a		Changelog added (this table) for OS and content updates. Page 241.
	New Arp / Seq Rate. Total 12 divisions.	Arp table, Page 110. Seq table, Page 107.
	Chord pack editor improvements, renaming including adding the initialize option.	Chord pack editor. Page 44 & 45.
1.2.0 b	Hung Notes - All Notes Off Command added	The main menu contains this command. Updated in tables and also in notes section. Pages 26, 27, 40.
	Pads and display is dimmable.	The main menu, settings contains this command. Updated in tables and grid section. Pages 26, 27, 38.
	MIDI clock missing message shown on screen. Supports the changes that show screen alerts for no sound situations.	MIDI Section. Page 118.
	Performance for CPU and Clipping enhancements. - Global volume set to dB - Mixer levels - Red clipping indicator - Mixer sends range -90dB to 0dB.	Changes made. - Global volume graphic - Page 94 - Mixer level table text - Page 100 - Mixer send guide - page 99
1.2.0 c		- SD Card clarification, used microSD throughout. - Power supply warning, Page 17. - USB Audio context description, Page 228.
1.2.0 d		- Chords & Scales. Fixed errors. Page 214
1.3.0 a	Dirt synth engine added Patch editor redesigned USB mass storage access to the microSD	- Dirt Synth. Pages 90, 91, 94. Added Pages 105-106. - Patch editor. Page 96, 118. - USB Storage. Added Pages 242, 243. Page 34, 35.

12

Index

Index

A

Action 73, 173
Aggregate Device 232
Audio Output 230
Audio Structure 32
Auto Name 20

B

Backing Up 240–241
Bass Fills 150
Beat Fill 147–148, 150
 BeatFills 155
Bit Depth 71, 196
Brightness 238

C

CC 66, 69–71, 202, 204, 207, 218–219
Chain 163, 166–167
Chance 73, 173–174
Changelog 245
Chord 68, 212, 216
Chord Fills 148
Chromatic 138
Copy 22, 46, 133, 165
Custom Parameters 191

Custom Preset 192

D

Delay 70, 189, 195
Dirt 90, 105
Display 18
Distortion 196

E

Effects 183–184, 187, 193
Envelope 30
Euclidean Fill 152
Export 56

F

Fill 144–146, 155, 212, 214
Filter Cutoff 66
Firmware 235–237
Folder 67, 127
Function Pads 30, 42

G

Glossary 30
Grid 41, 123

K

Keyboard 20, 137
Knob Behaviour 238–239

Index

L

Licence 235
Limiter 30, 49, 61, 189, 197
Live Recording 134–135, 182

M

Main Menu 34
Master FX 188–190
Master Volume 21, 48, 61
Melody Fills 155
Micromove 75
microSD 15, 29, 32–33, 77–78, 240, 244
Microtune 64
MIDI 30, 201
MIDI Channel 67, 207, 212–213
MIDI clock 204–205, 207
MIDI Transport 205, 207
Move 75
Mute 41, 47, 123, 204

N

Note 64, 137, 139–140, 212, 218
Note Length 212

O

Overdrive 71, 196

P

Panning 65
Parameters 19, 60, 89, 127, 129, 132, 211
Pattern 32, 121–122, 125, 165, 167
Pattern Mode 30, 123, 125, 164
PC 67, 223
PERC 115
Perform 30, 181–182, 184
Perform Mode Quick Reference 185
piano roll 140
Pitchbend 64, 225
Play 21, 53, 166
Play Mode 53–54, 63
Playback 21, 42, 166
Power Input 15, 17, 244
Preview 23
Project 32, 38, 122

Q

Quick Reference 25

R

Randomize 74, 176, 178
Randomize Type 74
Redo 22

Index

- Registration 235
 - Repeat Grid 72
 - Repeat Type 72
 - Reset 23, 237
 - Resonance 66
 - Reverb 70, 189, 194
 - Root Note 142–143
- S
- Sample 67, 79–80, 82, 85, 88, 126–127
 - Sample Attack 69
 - Sample Decay 69
 - Sample End 68
 - Sample Packs 78–79, 86–87, 144
 - Sample Pool 32, 78, 81
 - Sample Start 68
 - Saturation 188–189, 196
 - Save 23
 - Scale Filter 142–143, 216
 - Scale Type 142–143
 - Scales 140, 142, 216
 - Screen Buttons 18–19
 - Screen Knob 19
 - Select 41, 123
 - Sequencer Mode 31, 41, 123–124, 126, 130, 134
 - Settings 34
 - Sidechain 199
 - Solo 41, 47, 123
 - Song mode 163
 - Sound FX 189
 - Specifications 244
 - Step Page 46
 - Step Selection 130–131
 - Steps 42, 121, 126, 130, 178
 - Stop 21
 - Swing 52, 62
- T
- Tempo 50, 62
 - Track 31, 42–43, 168
 - Track Length 42, 44, 63
 - Track Speed 51
 - Tracker 226
- U
- Undo 22
 - USB 15, 17, 208, 230
 - USB Storage Mode 34–35, 242
- V

Index

Variation 41, 123, 163, 168, 171

Velocity 212

View Mode 41–42, 137–138

Volume 65

W

WAV 77, 85

Work Step 89, 128

Workflow 24

Copyright © 2025 by Polyend

All rights reserved. This book or any portion thereof may not be reproduced or used in any manner whatsoever without the express written permission of the publisher except for the use of brief quotations in a book review.

Produced in the United Kingdom

November 2025 - Play+ OS 1.3.0 a

www.synthdawg.com

Synthdawg

