

Polyend Synth Manual

An Official Reference for The Polyend Synth



Contents

1. Overview	9
1.1 How to Use This Notebook.....	10
1.2 Hardware Overview	11
1.3 Start Up	13
1.4 Display & Control Layout.....	14
1.5 User Interface Conventions	15
1.6 QWERTY Keyboard	16
1.7 Basic Playback	17
1.8 Example Workflow	18
1.9 Shortcut Commands.....	19
2. Architecture	21
2.1 Glossary of Terms.....	22
2.2 Synth Audio Structure.....	24
2.3 Memory Card Structure	25
2.4 Settings Menu Map	26

3. Scenes	29
3.1 First Steps with Scenes	30
3.2 Selecting and Ordering Scenes.....	31
3.3 Creating a New Scene	32
3.4 Saving a Scene	33
4. Notes & Chords	35
4.1 Grid Layout.....	36
4.2 Playing Notes on the Grid	40
4.3 Polyphony & Voices.....	41
4.4 Chords & Smart Grid	42
5. Synths	47
5.1 Synth Engine Overview	48
5.2 Synth Preset Overview	49
5.3 Synth Parameter Options	50
5.4 Synth Selection & Configuration.....	51
5.5 ACD Synth Voice	54
5.6 FAT Synth Voice	57
5.7 WAVS Synth Voice	60
5.8 VAP Synth Voice.....	65
5.9 WTFM Synth Voice.....	69
5.10 PMD Synth Voice	73
5.11 PHZ Synth Voice.....	76
5.12 GRAIN Synth Voice	81

5.13 DWA Synth	85
5.14 DIRT Synth	90
5.15 MIDI Instrument	92
5.16 Macros	93
5.17 Filter	96
5.18 Envelopes	98
6. Effects & Modulation	101
6.1 Effect Structure	102
6.2 Effect Overview	103
6.3 MOD Effect	104
6.4 DEL Effect	105
6.5 REV Effect	106
6.6 Using the Effects	107
6.7 Mixer Page	108
6.8 Modulation Overview	109
6.9 Applying Modulation	110
6.10 Levels & Gain Staging	111
7. Sequencer & Arp	113
7.1 Sequencer & Arp Overview	114
7.2 Sequencer Overview	115
7.3 Using the Sequencer	116
7.4 Arp Overview	118
7.5 Using the Arpeggiator	119

8. MIDI & Connectivity	123
8.1 MIDI Terms	124
8.2 Basic MIDI concepts for Synth	125
8.3 MIDI Configuration	126
8.4 External Keyboard Configuration	127
8.5 External Control Change Messages.....	128
8.6 External Program Change Messages	130
8.7 External DAW Control	132
8.8 MIDI CC Mapping	133
9. System	137
9.1 Generic Firmware Update	138
9.2 Emergency Firmware Update.....	139
9.3 Grid Pad Behavior Settings	140
9.4 USB Storage Mode	141
9.5 microSD Card Compatibility & Backing Up ..	142
9.6 CPU Performance Considerations	144
9.7 Official Specifications	145
9.8 Changelog	146
10. Index.....	149

Overview

Synth is a multi-engine polyphonic synthesizer. It consists of 3 synth engines, each selectable from the available engine models. Some engines have an element of familiarity, being conceived in the Polyend Tracker and Play family of devices. Others are new or inspired by classic synths, expanding the sonic possibilities even further. The Synth workflow and structure revolves around 'Scenes.' A scene is a collection of all of the elements, including presets, macros, settings, effects, and parameters that create the sound and pattern. These are stored on the microSD Card. Each synth has a unique character and is typically set up with a filter, envelopes, and applied modulation. Macros enable multiple parameters to be controlled by a single knob. Synth has three configurable macro knobs. A

sequencer and arpeggiator allow patterns to be recorded and generated in addition to playing pads manually. Finally, an effects section consists of Mod, Delay, and Reverb effects. These operate as send effects where an amount of the synth audio output is sent to each effect, which is then mixed into the master output. The synth sounds are combined and controlled in the mixer section, which also controls the effect sends and the panning. This section introduces the hardware and provides a generic overview of the Synth components.

1 Overview

1.1 How to Use This Notebook

This book combines a formal reference alongside your own notes and comments, collectively bringing together a comprehensive guide to Synth.

Sections are laid out to cover the full workflow with walkthroughs, step by step guides and tips. Some pages carry a wide margin and some are intentionally blank enabling you to make your own notes.

Control conventions.

(Knob)

Rounded parentheses represent the touch capacitive knobs. Selected functions can be controlled or changed depending on the context. The knobs will be labelled by its primary or secondary function name. Also the multi-function screen navigation knob is included, labelled as (Screen).

[Function]

Square parentheses contain functions that are selectable by a physically dedicated button - either as a primary or secondary, shift accessible function. Examples are [Engine] and [Scene].

[Function] + [Option]

Functions which require multiple button selections simultaneously are shown with a + symbol between each required button. An example is the [Shift] + [Effects] command. The secondary function label is named.

[Dynamic Screen Key]

The 3 dynamic screen buttons located underneath the display screen will be identified using *italic* text. The actual function that each button serves will change depending on the current context. The function it serves will be labelled on the screen above each physical button on the device. These also are used generically to select each one of the 3 synths.

[Pad]

Each of the 5x12 pad buttons will be simply represented by [Pad]. These functions will depend on the mode and function selected within Synth.

'Text'

Any screen menu options and text is indicated with quote marks.

NOTES

Your Notes Can be written here Here

Did you know?
Synth is shortened from
'Synthesizer'. The first
ever synthesizer is
credited to RCA and was
released in 1955.

1.2 Hardware Overview

3.5mm Stereo audio output also serves as headphone out.

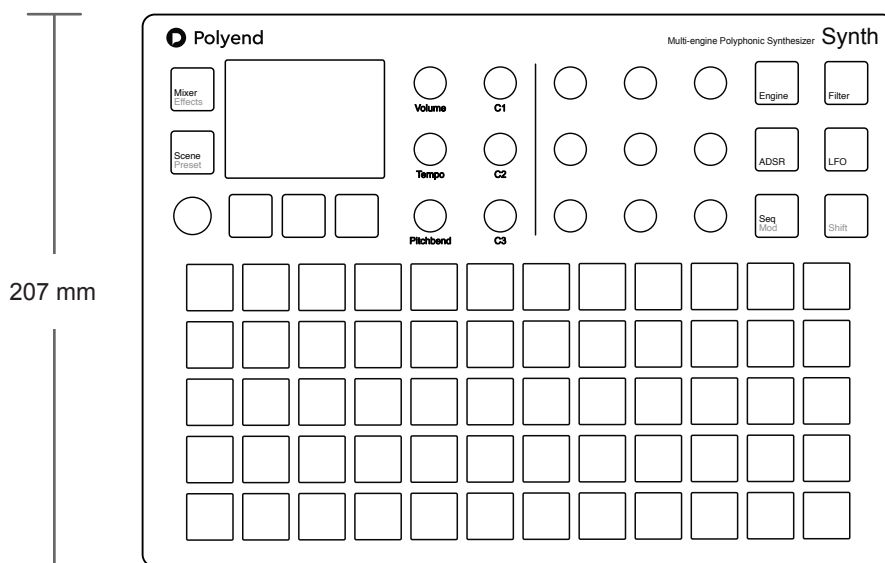
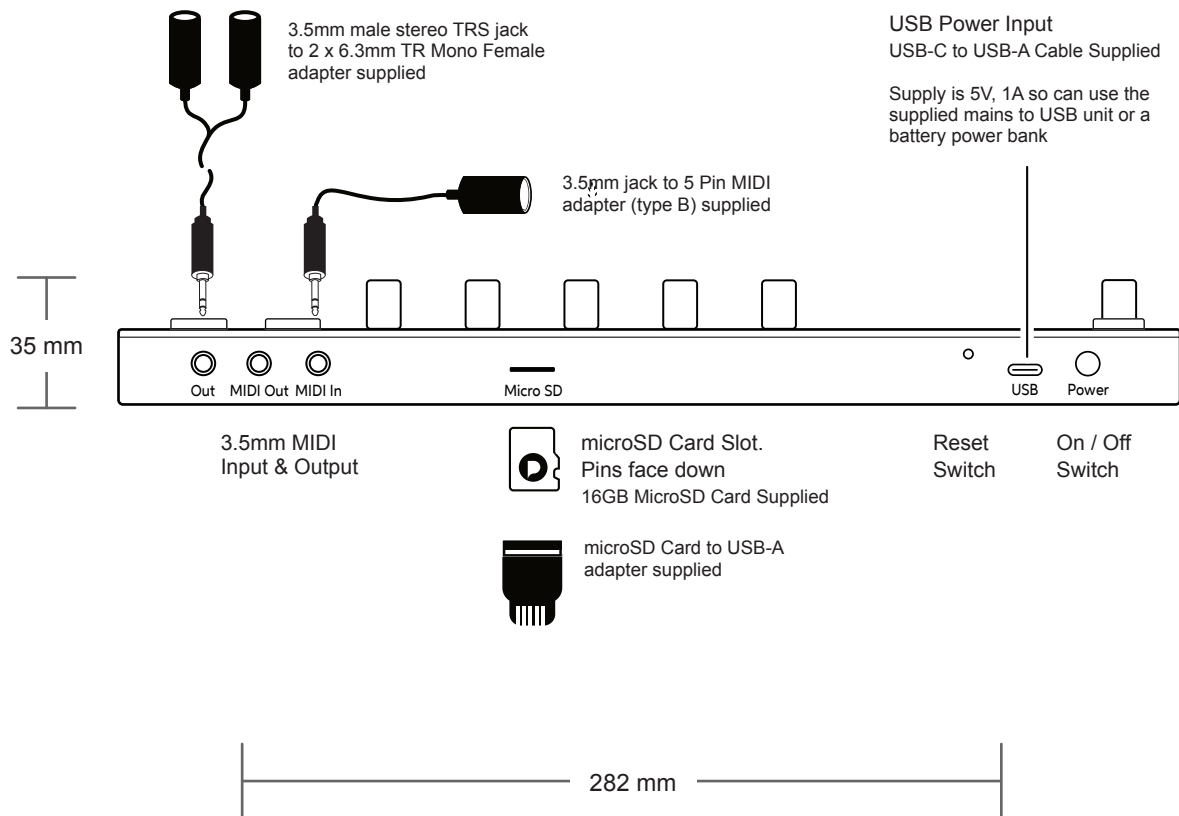

1 Overview

- 1** LCD Display
Hi Resolution Display.
- 2** Synth Engine / Multi Function Buttons
Each [Screen] button selects one of the 3 synth engines or selects a defined option in a function menu.
- 3** Multi-Functional Screen Knob
Clickable encoder. Click to select the main menu. Turn to change synth function pages. (Screen).
- 4** Grid Pads
5 x 12 Silicone [Pads]. Configurable for playing and controlling the 3 synth engines.
- 5** Parameter Knobs
9 Dynamic knobs control the respective parameter set for the function displayed on the screen.
- 6** Master Volume
Control of primary master (Vol) dB level.
- 7** Tempo & Swing
Adjusts the global (Tempo). Range is 10 to 400 beats per minute. Use Shift to adjust swing 25%-75%.
- 8** Pitchbend
Adjusts the (Pitchbend) value -100 to +100 only while turning the knob. Resets to 0 when the knob is released.

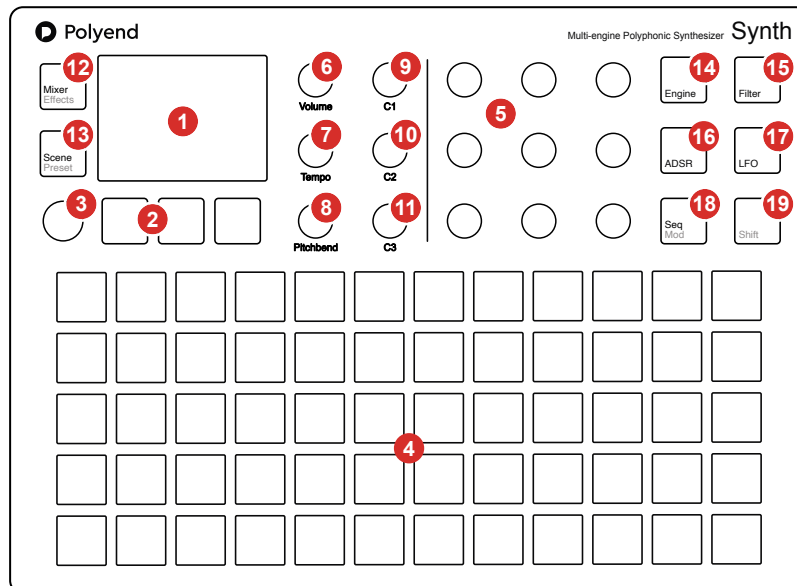

- 9** Macro 1 & Combo Control.
Adjust synth macros or relative common parameters for all or selected synth engines using one (C1) knob.
- 10** Macro 2 & Combo Control.
Adjust synth macros or relative common parameters for all or selected synth engines using one (C2) knob.
- 11** Macro 3 & Combo Control.
Adjust synth macros or relative common parameters for all or selected synth engines using one (C3) knob.
- 12** Mixer & Effects
Opens the mixer page for Level and Pan of all the synth engines. Shift to open the ModFX parameters.
- 13** Scene & Preset
Opens the [Scene] manager to load & save. Use [Shift] + [Scene] to open the synth preset browser.
- 14** Synth Engine Osc Parameters
Opens the oscillator page for the selected synth engine. Engine is selected with [Screen] buttons.
- 15** Synth Engine Filter Parameters
Opens the filter page for the selected synth engine. Engine is selected with [Screen] buttons.
- 16** Synth Engine ADSR Envelope Parameters
Opens the Filter and Amp Envelope pages for the selected synth engine. Selected synth with [Screen].
- 17** Synth Engine LFO Parameters
Opens the Low Frequency Oscillator pages for the selected synth engine. Selected synth with [Screen].
- 18** Sequencer Mode & Modulation Routing
Opens the sequencer mode page for the selected synth engine. Shift to adjust modulation amounts.
- 19** Shift
Use [Shift] in conjunction with a control to access a secondary function, e.g. the button grey text option.

The 5 x 12 grid pads are velocity sensitive. All knobs with the exception of the left side screen knob are touch sensitive.

1.3 Start Up

Synth is a low power user and can therefore be powered from the supplied mains USB adapter or from a rechargeable battery power bank. When restarting Synth the previously open scene will be re-opened

POWERING ON / OFF SYNTH

1. Connect the supplied USB-C mains cable between Synth and the supplied USB plug. Also Synth can operate with a portable USB power bank*. Synth requires a 5V, 1A rated supply.
2. Ensure the microSD Card is installed correctly for Synth to operate.
3. Quickly press the small power button located on the rear left (looking from the top). Synth will start up and the previous scene reopened.
4. To power off, press and hold the small power button located on the rear left (looking from the top) until the 'Powering Down' message appears and the timer bar ends. Synth will power off.

Supply is 5V, 1A from the supplied mains to USB adapter

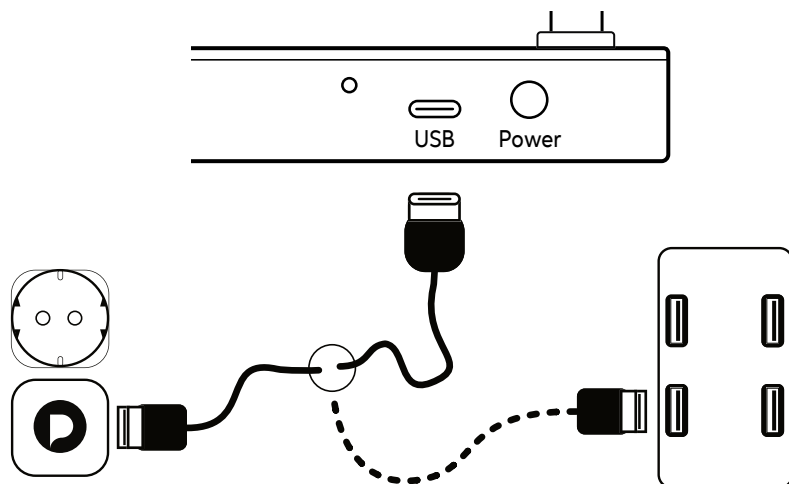

Alternatively use a battery power bank.
Start up instantaneous current is approx 1.2A with normal state around 0.5A

** It is recommended by Polyend to use a standard power bank without smart features. Intelligent / smart power banks or PC / Mac power may have features that interfere with the continuous supply required by Synth. A USC - C to USB - B cable is supplied.*

1 Overview

1.4 Display & Control Layout

NOTES

Each page will display the parameter information and control options for the selected function. While generally this is based on the context and mode of operation, there are some common features and navigation principles that apply across all (or most) of the generic pages of Synth.

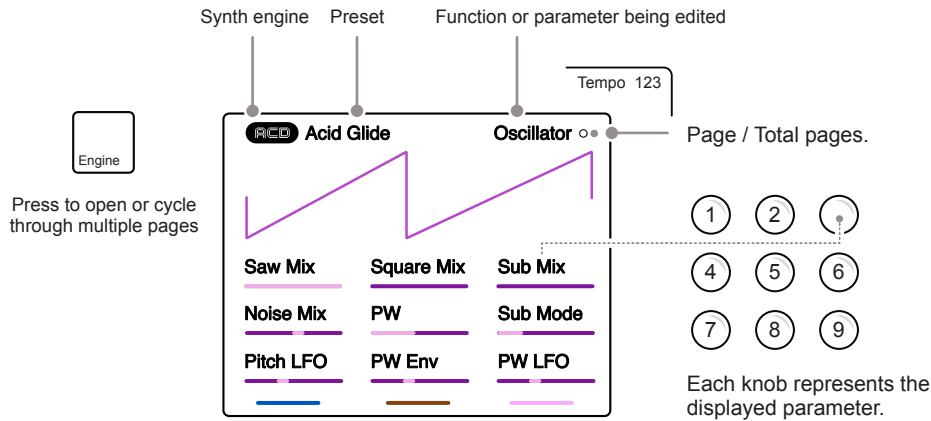

Colour scheme represents the synth engine selected

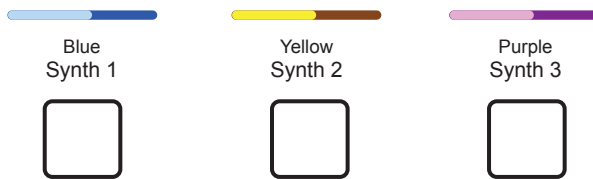

The 3 [Screen] buttons located under the display represent each of the synth engines 1, 2, 3 by default. In some menus, these buttons will represent the specific function which is displayed directly above the button.



The values, range and scale displayed will depend on the function and the parameter represented.

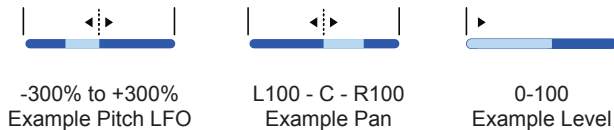

[Engine] Square brackets in the descriptions represent the physical button or pads on the front panel. Push or hold to activate.

(Vol) Round brackets in the descriptions represent the physical knobs on the front panel. All knobs except the screen knob are touch sensitive. Knobs can be turned and / or tapped.

1.5 User Interface Conventions

Adjusting parameters and setting steps follow a defined process. Simply tapping a [Pad] will play a note, and holding [Shift] + tapping [Pad] will lock the note on. Defined buttons select the labeled function; the grey lower label refers to a command using shift.

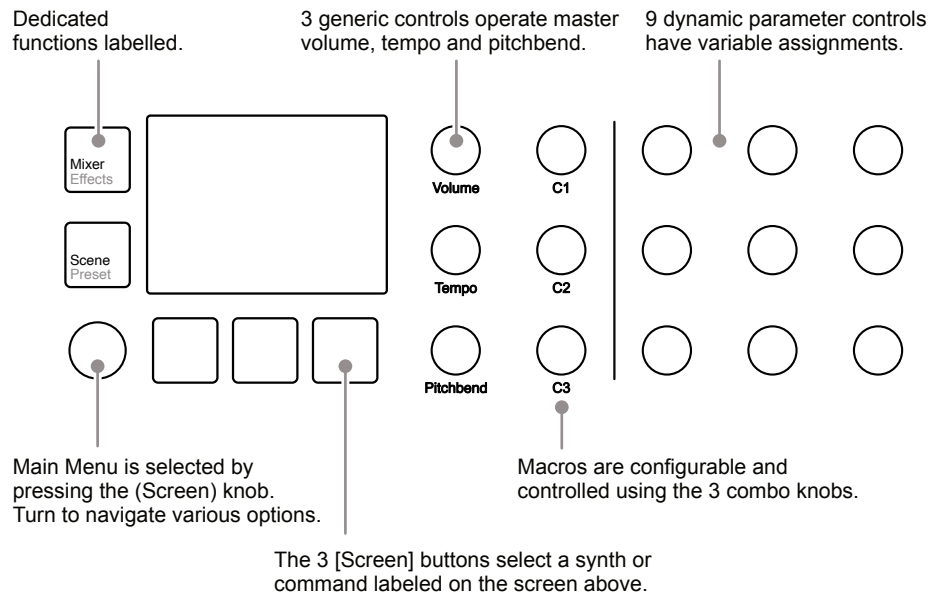

Notes on using the control interface

- The 15 parameter knobs are touch sensitive, and its parameter is automatically selected when touched. Turn a (Knob) to change its value or parameter setting.
- Press [Shift] + turn (Knob) on some parameters to change the value with a faster resolution of adjustment. This will increase the speed of adjustment when changing values across its range. This precise behavior is dependent on the parameter selected.
- The (Screen) knob is not touch-sensitive. The rotation has detent control and is push-clickable. Press (Screen) to select and to navigate the global settings menu. Also press (Screen) to select an option and to move back when navigating.
- The (Screen) knob will change any selected parameter value in the same way as the parameter knobs. It will also navigate within the global settings menus.
- The three [Screen] buttons generally select each of the 3 synths. They can also operate the command displayed above.

1 Overview

1.6 QWERTY Keyboard

NOTES

Some functions require text editing, such as saving and naming scenes. The same functionality applies whenever the alphanumeric pop-up editor is used. The screen displays the QWERTY keyboard and the text string to edit, while the 5 x 12 pad grid acts as the keyboard's input. The screen buttons are also available to select actions.

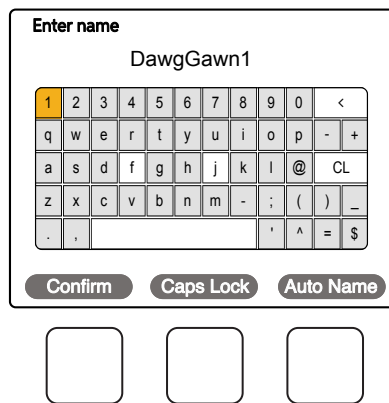

The screen will display the characters represented by the grid pads. The 'f' and 'j' pads are highlighted to give a reference between them and the screen characters. Text can be typed in with the currently selected character lit orange on the display and the pad.

1	2	3	4	5	6	7	8	9	0	<	
q	w	e	r	t	y	u	i	o	p	-	+
a	s	d	f	g	h	j	k	l	@	CL	
z	x	c	v	b	n	m	-	;	()	_
.	,							'	^	=	\$

The following Synth controls also operate in the naming editor when the naming screen is presented:-

- Press (Screen) to add the highlighted character at the current cursor position in the name string.
- Move the character cursor left or right within in the text name string, turn (Screen) knob.
- The dynamic screen buttons action specific commands, as displayed above the button. Confirm, Caps Lock and Auto Name are the three available commands.

1.7 Basic Playback

The 5 x 12 pad grid is used to play notes for each of the 3 synths. The synths will be laid out in a formation set in the grid settings which are located in the main menu. Each synth is represented in the user interface by a designated colour scheme.

PLAYING SYNTH NOTES

1. Ensure a scene is open with each of the 3 synths loaded with a preset.
2. Press [Pad] to play the note. The range of pads covered represents each synth. The layout is based on the grid option selected.
3. Pads are velocity sensitive so the harder the pad is played, the louder the sound is played. Velocity is by default mapped to volume. Also pads are polyphonic aftertouch. Pressure continuously applied after pressing a pad can control up to 5 macro defined parameters.
4. To latch a note on, hold [Shift] + press [Pad]. The note will be latched and will play continuously if the synth engine allows. Double tap [Shift] to release all latched notes or hold [Shift] + press [Pad] again to release individual notes.
5. Multiple notes can be played and / or latched simultaneously. The voice setting in the main menu under 'Synths' must be set to allow multiple notes to trigger the sound. For example, to trigger a triad chord for one synth you would need to allocate 3 voices to that synth.
6. Note that depending on chord mode setting for the synths, the notes played may or may not affect another synths notes.

ADJUSTING THE MASTER VOLUME.

1. Touch (Volume) to select and display the parameter top right.
2. Turn (Volume), ideally while playing a synth to hear the level applied.

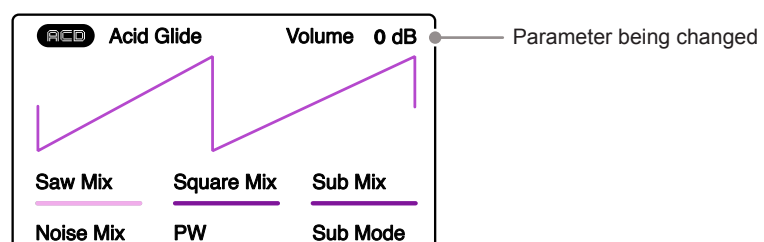

1 Overview

1.8 Example Workflow

The workflow adopted with Synth will of course develop to fit your personal approach. To get started a typical journey is described below which covers the basics of getting started with sound design.

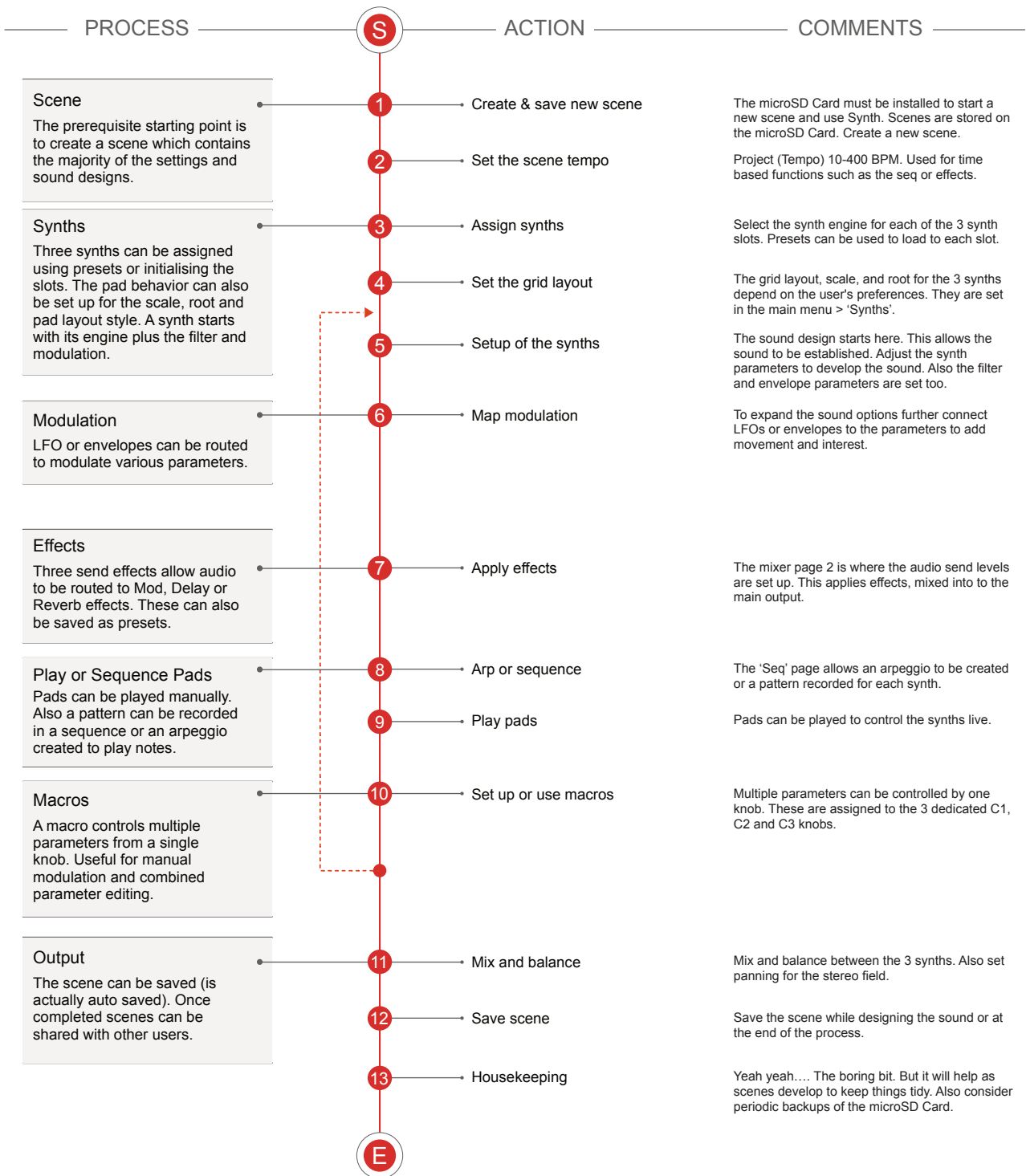

1.9 Shortcut Commands

Other than the labelled buttons a number of shortcut commands also exist. These are covered here as a quick reference.

Function	Action	Buttons	Description
Pads	Play Pad	Press [Pad]	Plays the pad note.
Pads	Lock Pad Play	Hold [Shift] + press [Pad]	Locks pad selection on or off. Locks note on.
Pads	Clear Locks	Double tap [Shift]	Removes all pad locks. Sets the locked pads to note off.
Effect	Select Effects	Hold [Shift] + press [Filter]	Opens the effects pages. Alternative to [Shift] + [Effects].
Preset	Effect Preset	Hold [Shift] + press [Preset]	From any effect page, opens the effect preset browser.
Preset	Engine Preset	Hold [Shift] + press [Engine]	Opens the engine preset browser for the current synth.
Preset	Engine Preset	Hold [Synth X] Screen Btn + [Scene]	Opens the engine preset browser for the chosen synth X.
Synth	Root Note	Hold [Synth X] Screen Btn + (Screen)	Turn screen knob to set the root note for the chosen synth X. This is the same option as in grid page.

2

Architecture

Synth has eight voices, which can be allocated across the three synth engines. There are so many features that are less obvious to producers who are familiar with more traditional sequencers and DAWs. The overall structure of Synth is quite simple, but it is worth spending a little time understanding the associated terminology and design. A good starting point is to get to know the architecture of the overall device, which is why bringing this summary upfront in this guide is helpful. A solid understanding and awareness of the Synth structure will help enormously get to grips later with the rest of the device. The three essential elements to get started are the Synth device itself (of course), a USB power source (power or mains adapter), and the populated and configured microSD

Card, which is integral to Synth operation. It is also possible to interface Synth with other audio and MIDI devices to expand the system using MIDI. While more in-depth details for specific topics are covered in the following sections of this notebook, the overall foundation and structure are laid out in this section. The hierarchical structure and organization of data and functions such as scenes, synths, and effects are summarised collectively and how they work together. It is, therefore, worth the investment of time and focus in understanding the architectural hierarchy. Developing a fundamental workflow and efficient process will help get the most out of Synth's comprehensive feature set.

2 Architecture

2.1 Glossary of Terms

While you may think this should be hidden at the back of this book, understanding the terminology associated with these topics, especially Synth, will help unlock its power and performance. It makes sense to become familiar early with the essential terms to help embed them into your workflow.

ADSR: A type of envelope that allows control over the attack, decay and release times plus controls the sustain level of the envelope shape.

Arp. Shortened from arpeggiator. A sequence generator which operates by breaking a chord into discrete notes and generating a looping pattern.

Beta: A term normally used for pre-release software versions used for testing purposes. Polyend often release beta versions of Synth.

CC Messages: CC or continuous controller change messages are a MIDI communication protocol used to change parameter values issued from one device to another.

Chord: A collection of two or more notes played together. A chord will include a root note. Chords are played to develop a melody or musical progression.

Delay: An effect function which creates echo's and repeats of the audio signal.

Effects: Refers to the master effects used across the overall output audio. Also called FX.

Envelope: An envelope is used to modulate and shape parameters and audio over time. Synth has an envelope control function for amp and filter.

Engine. This is the function which generates the synth audio and contains all of the elements and parameters that contribute to the synth engine's style and character.

Filter: A function which affects the frequency content across the audio range. The filter cutoff is the point from which frequencies are removed. In subtractive synthesis, a filter carves out frequencies to shape the overall tone and sound.

Firmware: The software that operates the Synth. Firmware updates introduce new features as well as system improvements.

Grid. The configuration of the 5 x 12 pads. The arrangement can be changed to reorganise the grid layout in the main menu.

LFO. Low frequency oscillator. An oscillator that operates at a slower speed in order to modulate other parameters based on its shape and speed.

Macro. A combination of parameters clustered together to control multiple values and settings simultaneously by a single knob.

microSD Card: A storage device that is used in Synth for holding data, samples, project etc. Synth is supplied with a 16GB microSD Card and USB adapter.

MIDI: MIDI stands for musical instrument digital interface and is a standard protocol used for communicating between equipment. MIDI is normally applied using 5 Pin MIDI DIN connections which in some cases (i.e. with Synth) are interfaced via a MIDI 5 Pin to 3.5mm MIDI dongle.

Modulation: The process of changing and varying a parameter value. Typically one function for example an LFO is used to control the value of another function, e.g. filter cutoff.

Mixer. A function which balances the levels from multiple sources, in this case the levels of each synth are managed collectively as well as stereo panning.

Note: A musical note assigned to a samples pitch and assigned to track steps to create a melody or percussive beat.

OS: Operating system is the core software that makes Synth work. It handles how it operates and periodic updates from Polyend bring new features into use.

Oscillator: The source device that generates audio within a synthesizer. The pitch is controlled by speed and audio character by the wave shape.

Parameter: The individual value of a specific function or control element. A parameter can be adjusted to affect a sound or change a functions operation.

PC Messages: PC or program change messages are a MIDI communication protocol used to change presets, patches or banks issued from one device to another.

Pitchbend. A common synth feature which is used typically for playing live. This changes, while adjusting the knob, the pitch of the sound.

Preset. A collection of synth parameters and settings that create its distinct sound. These can be saved and recalled. Used interchangeably with the term patch.

Power Bank. A portable rechargeable battery devices used to power or recharge portable equipment.

Polyphony: The ability of an instrument to play multiple notes simultaneously. This is managed through the allocation of an audio voice per note.

Reverb: An effect function which emulates the behavior of audio in a room or space. The echos and reflections form the sound character.

Root: The main note that establishes a key or scales tonality. Usually the first note which operates as the foundation in a chord.

Sample: The basic audio element that are used by some synth engines such as wave or grain.

Scene. The highest order element in the overall structure of Synth. Contains all of the elements when creating a musical production or sound design project. Synth can display and access up to 250 scenes.

Screen Buttons: 3 dynamic buttons which will operate functions based on the mode. The function that is controlled is displayed on the screen. Typically the 3 screen buttons select a synth to edit.

Sequencer: A function that records and replays a note pattern. Various parameters are configurable in a synth sequence.

Slot: Generic term used to refer to a location based on context. A slot could be a synth slot or a scene slot for example.

Swing: The natural feel of a pattern often brings some note timing forwards or backwards.

Synth: An electronic instrument for creating sounds. Polyend Synth has 3 onboard configurable synths that can be used as a sound source. Various synth engines are available.

Tempo. The beats per minute setting that dictates the speed of Synth. This sets the internal clock speed for time based elements such as delay or sequencer and to synchronise internally or externally over MIDI.

Update: The process of installing the newest firmware. This brings new features and fixes bugs associated with previous versions.

Voice: A voice is an audio 'channel' uniquely allocated to one note in a polyphonic synth. A voice would include its associated audio parameters. To create a triad chord, 3 voices would be required, one for each note.

USB: A digital connection type used for communicating between devices, firmware updates and sometimes as a power source. Synth has a USB-C connection used for MIDI and Data communication.

2 Architecture

2.2 Synth Audio Structure

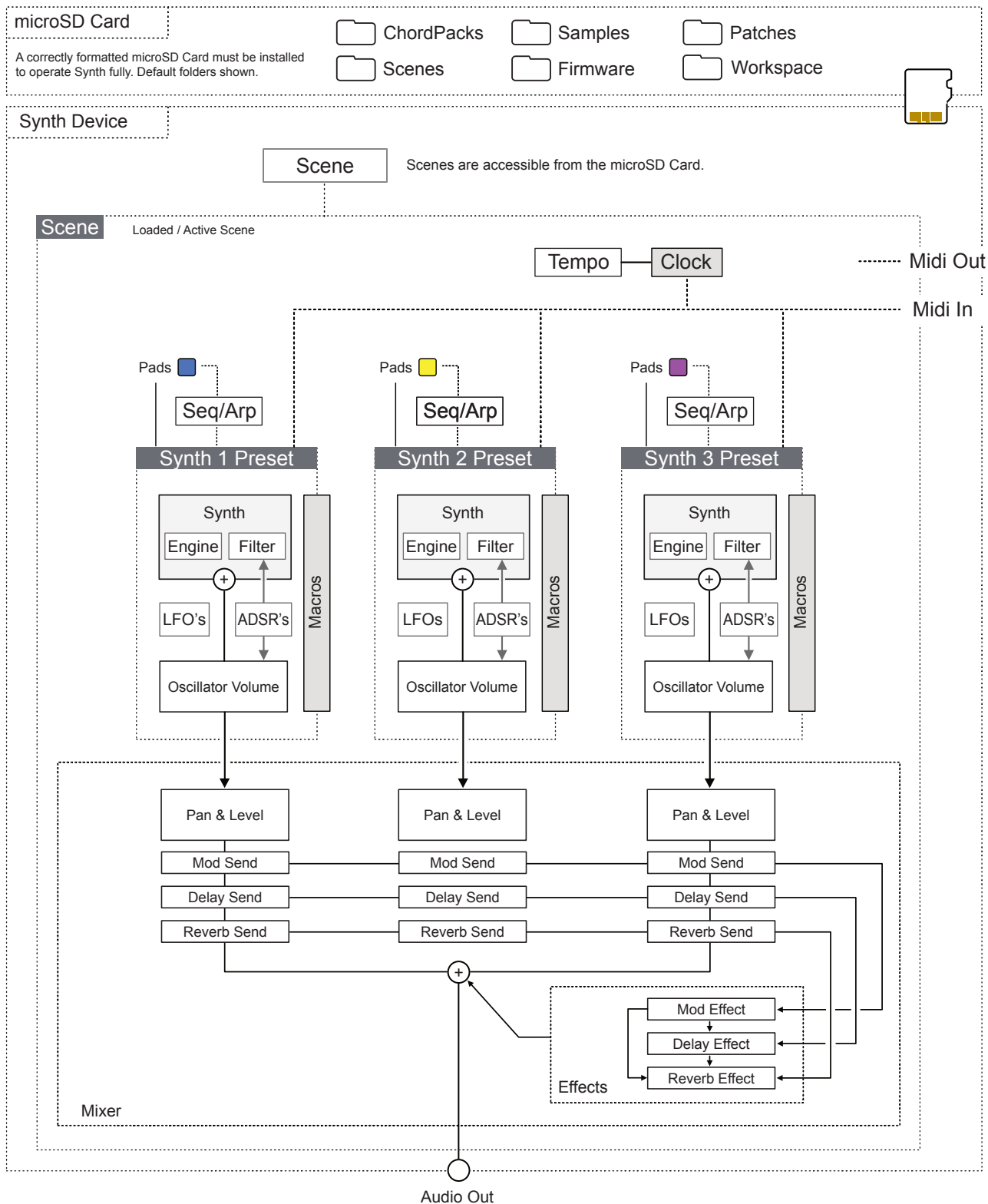

Diagram is a single line illustration, used only for guidance. This is not a detailed schematic and does not show the line in stereo.

2.3 Memory Card Structure

The microSD Card is an integral part of Synth and must be inserted to operate correctly. An alert message is displayed if Synth is powered up without an microSD Card installed. It is important that the correct format is applied to the microSD Card. This should be FAT32 with master boot record (MBR) partitioning.

The default file structure will expand as different functions are used.

Files and folders can be accessed with a PC or Mac. A USB Card adapter is supplied with Synth.

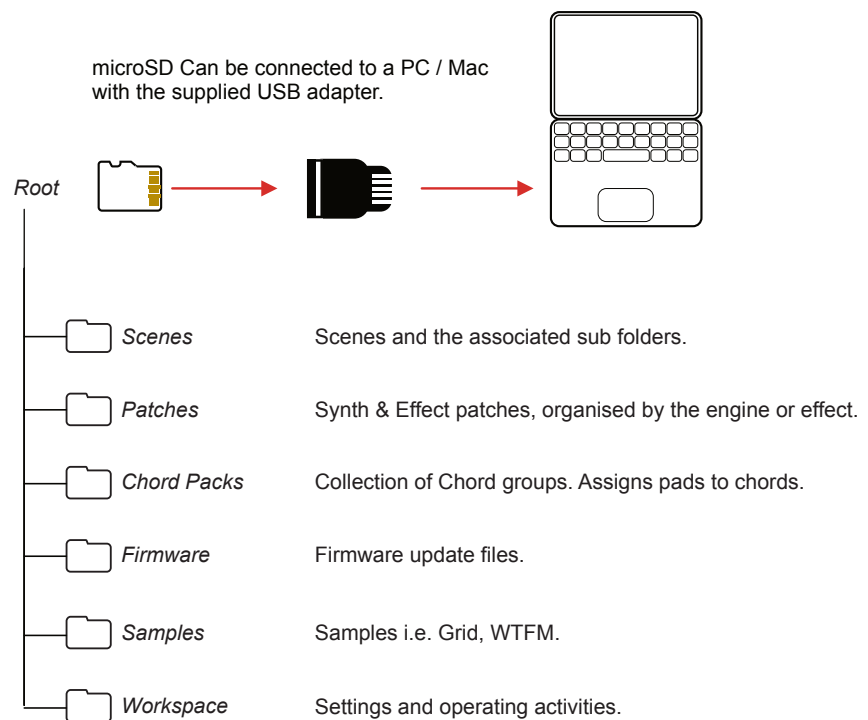

New folders may be created when accessing some of the functions in Synth.

Always backup the microSD card content on a regular basis and before performing an OS Update. Check each update documentation from Polyend when an update is released for specific information.

2 Architecture

2.4 Settings Menu Map

NOTES

As a quick guide to the settings and main menu hierarchy in Synth the following diagram illustrates the main pages.

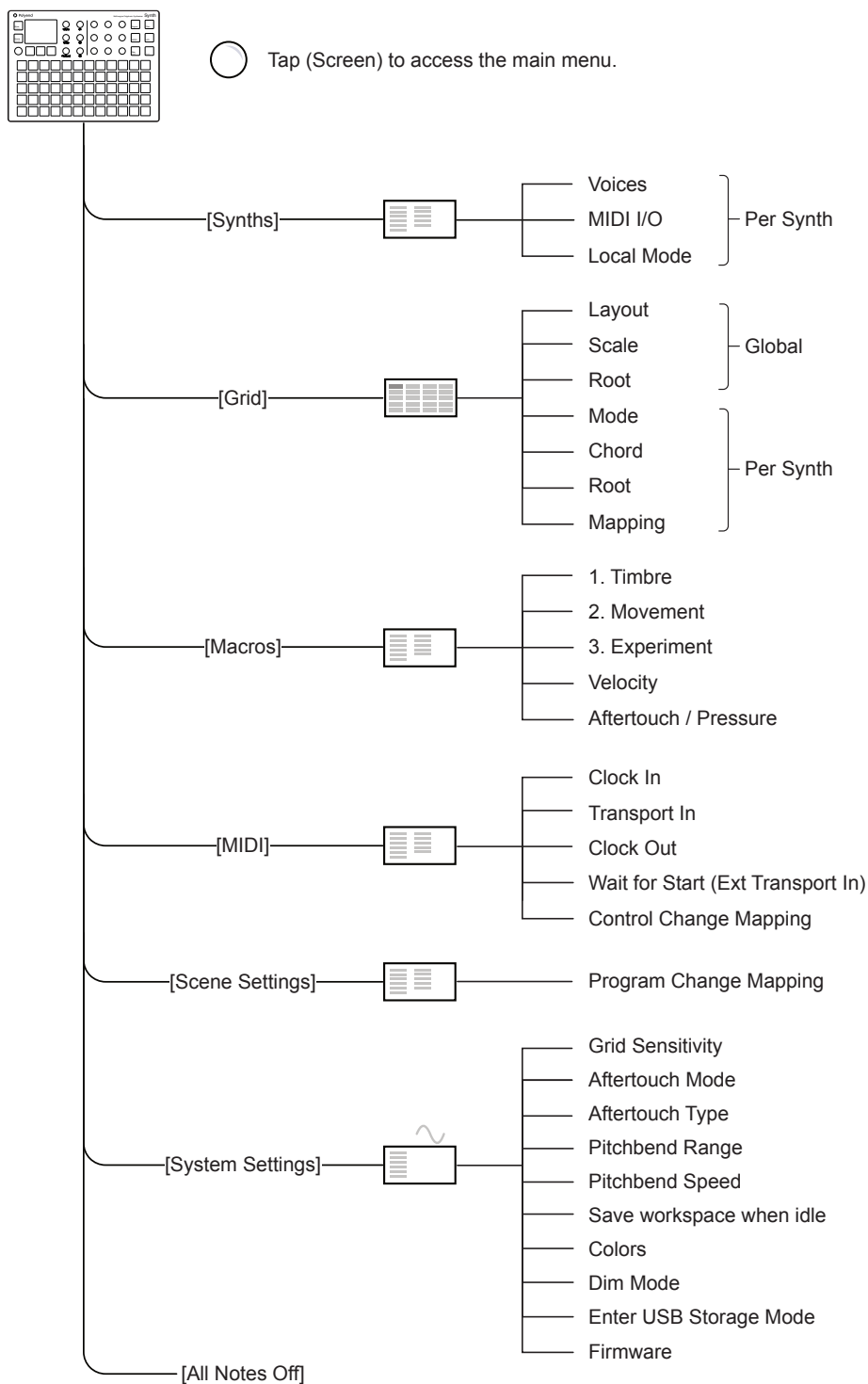

Menu	Option	Description
Synths	Voices	An audio 'channel' allocated to a single note in a polyphonic sound. Synth has a maximum number of 8 voices which can be allocated across the 3 synths.
Synths	MIDI channel	The MIDI channel assigned to control the specific synth.
Synths	Local mode	Local mode 'On' allows the pads and/or MIDI to control the synths. When off, pads are disconnected and Synth is controlled using an external MIDI controller only.
Grid	Layout	Selects the pad layout style for how the synths are mapped to the 5 x 12 grid.
Grid	Scale	Generic scale setting across the synths.
Grid	Root	Global root note.
Grid	Mode	Selects the pad function. Selects from note or a selection of chord options.
Grid	Chord	Selects a chord or chord pack.
Grid	Root	Root note and octave for the specific synth.
Grid	Mapping	Note layout across pads, Wrap - notes bottom left to right or note+ to increment up the rows in semitones.
Macros	1. Timbre	Macro 1 plus name assigned to 'C1' knob. Controls a set of assigned parameters.
Macros	2. Movement	Macro 2 plus name assigned to 'C2' knob. Controls a set of assigned parameters.
Macros	3. Experiment	Macro 3 plus name assigned to 'C3' knob. Controls a set of assigned parameters.
Macros	Velocity	Velocity macro and the assigned parameters.
Macro	Aftertouch / Pressure	Pressure and aftertouch macro and the assigned parameters.
MIDI	Clock in	Sets Synth to recognise an external MIDI clock as the primary tempo control.
MIDI	Transport in	Assigns the port for transport in control.
MIDI	Clock out	Sets Synth as a primary clock sending clock tempo out to an external MIDI device.
MIDI	Wait for start (Ext transport in)	Allows Synth sequence or Arp to respond to external MIDI transport messages.
MIDI	Control change mapping	Utility to display the CC messages mapped for each accessible parameter.
Scene Settings	Program change mapping	Utility to map PC messages 0-7 to presets.
Settings	Grid sensitivity	A selection of settings for pad playback and velocity behavior.
Settings	Aftertouch mode	A selection of settings for aftertouch behavior.
Settings	Aftertouch type	Polyphonic or channel
Settings	Pitchbend range	Range of pitchbend. 1-24 semitones.
Settings	Pitchbend speed	Speed that the pitchbend control returns to zero.
Settings	Save workspace when idle	Auto save of the workspace and scenes.
Settings	Colors	Adjust pad color for each synth.
Settings	Dim Mode	Dims the pads and display when set to on.
Settings	Enter USB storage mode	Sets the Synth to be seen as an external drive when connected by USB.
Settings	Firmware	Opens the firmware details page and the firmware update feature.
All Notes Off	Command	This command clears and resets all notes and releases any hanging notes.

3

Scenes

Scenes are the highest order in the structural configuration of Synth. A scene contains all elements for a designed sound, including synth parameters and presets, layouts, and settings. Think of each scene as the project folder or structural container for the entire set of 3 synths and associated functions. Synth saves scenes on the installed microSD card. A scene is always open for playback and editing and can be created from scratch for new projects, or one can be selected from the factory library. Scenes can be initialized to create a new scene with default settings. Scenes can be selected using the screen knob navigation or the grid pads. Creating a scene is, therefore, the place to start with Synth,

although the previously opened scene will be reopened automatically on start-up. The main thing to remember about scenes is that it is the primary way to organize the sound designs and synths and to store, recall, and even share with others. A factory library of scenes is included out of the box to get things started.

3 Scenes

3.1 First Steps with Scenes

NOTES

Scenes are the core structural elements of the Polyend Synth. A scene is a collection of patches, settings, macros, parameters and sequence data. Think of a scene as one specific section or building block that contributes to a complete song or arrangement. A scene is the container for the all of the musical elements and helps to compose and organise discrete sections of an arrangement by working with manageable parts.

A collection of artist scenes are available in the factory library that showcase how Synth is used as an instrument, offering unique insights into the composition of the scene and bringing a signature style and flair to the collection.

Once created, scenes can be copied and shared in the community with other Synth users.

Components of a scene

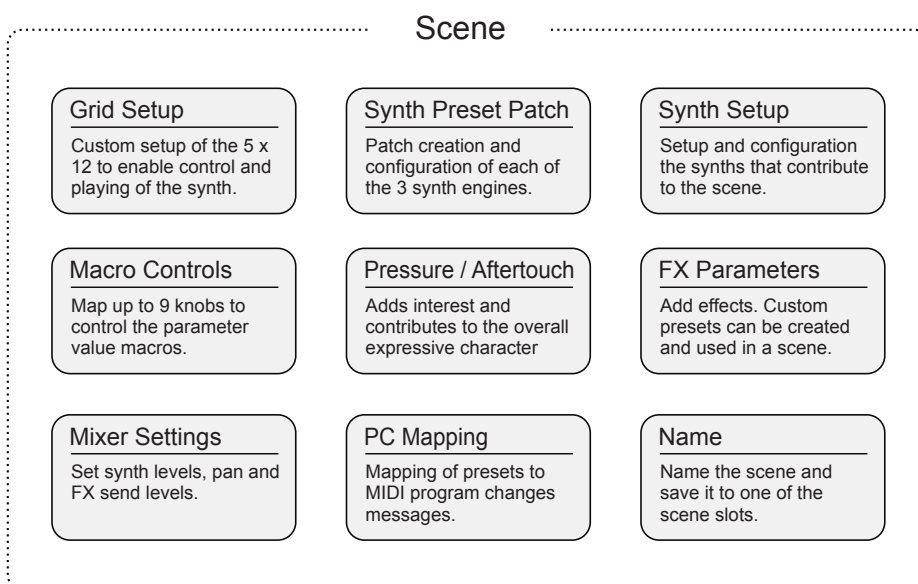

To create a scene, the configuration and development of these elements is required. The assembly of these will develop sounds and construct the scenes that can be used together in a wider production. You will develop your own workflow but the following steps cover the basic principles of scene creation.

3.2 Selecting and Ordering Scenes

Scenes can be managed directly by using the dedicated [Scene] button located to the left of the display screen. Up to 250 scenes are accessible from Synth and more can be saved on the microSD Card. Scenes are listed with the 'P' number which refers to the selection grid pad for the scene.



Press the [Scene] button to open the scene menu options. Turn (Screen) to scroll and navigate the menu. Press (Screen) to select the highlighted option or sub-menu.

Navigate the list with the (Screen) knob.

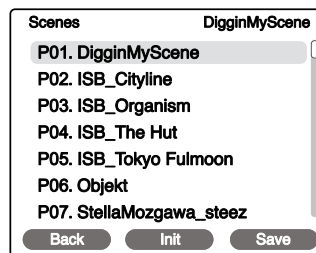

Currently active scene

Press the screen buttons located below the display to navigate backup in the menu. Press (Scene) knob to open the highlighted scene.

OPENING A SCENE

1. Open the scene menu. Press [Scene] button. If needed, the 'Back' screen button option will step back to the prior screen page.
2. Turn (Screen) knob to navigate the list and to highlight a scene.
3. Press (Screen) knob to select the highlighted scene and load it as the active scene. One scene will always be active.
4. After pressing the [Scene] button pads can be used to select a scene. Tap a dimly lit pad to select the scene. Brightly lit pad is the current scene. With less than 60 scenes, unlit pads have no scene assigned.

REORDERINGS SCENES

1. Open the scene menu. Press [Scene] button.
2. Turn (Screen) knob to navigate to the scene to re-order.
3. Hold [Shift] + tap [Reorder] screen button. This will tag the highlighted scene ready to be relocated.
4. Turn (Screen) knob to move the scene within the list.
5. Press (Done) screen button to confirm the new location.

3 Scenes

3.3 Creating a New Scene

NOTES

A new scene can be created by initialising a scene from within the scene menu. This creates a new scene with a default set of synths and parameter settings. It is good practice to save a scene once created to avoid losing any sound design developments through the process.

CREATING A SCENE

1. Open the scene menu. Press [Scene] button. If needed, the 'Back' screen button option will step back to the prior screen page. The currently active scene is displayed top left in the scene page.
2. Press [*Init*] screen button. This creates and opens a new scene ready for editing. The parameter settings will be reset to defaults and an instance of the ACD synth will be assigned to each slot.
3. It is recommended to save a scene once created.

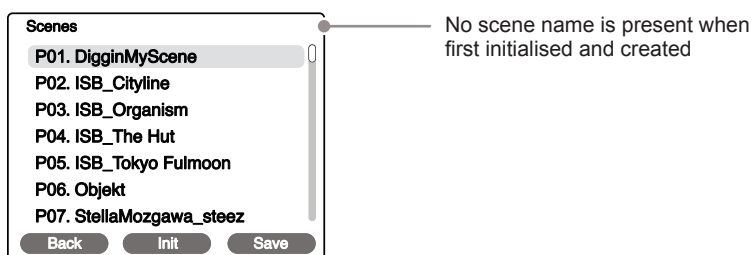

Choose [*Init*] to create a new scene.
The name is assigned when saving the scene.

3.4 Saving a Scene

A scene can be saved at any time to the original slot and name or saved as a new scene with a new name assigned. These actions are performed in the scene menu.

SAVING A SCENE

1. Open the scene menu. Press [Scene] button. If needed, the 'Back' screen button option will step back to the prior screen page. The currently active scene is displayed top right in the scene page.
2. To save to an existing slot. Press [Save] screen button.
 - This opens the naming editor to offer the option to rename the scene. The currently highlighted scene in the list will be renamed or overwritten. Ensure the original scene and name is selected first.
 - Edit the name if required, accept the current name or press [*Auto Name*] to automatically choose a new name.
 - Press [*Confirm*] when complete to save.
3. To save to a new slot with a new name. Hold [Shift] + press [Save As] screen button.
 - This opens the naming editor to offer the option to create a name for the scene. Name will initially be presented blank.
 - Edit the name if required, accept the current name or press [*Auto Name*] to automatically choose a new name.
 - Press [*Confirm*] when complete to save with the new name.

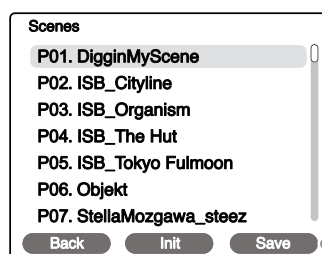

Press 'Save' or use [Shift] to 'Save As' the current scene.

4

Notes & Chords

The grid pad in Synth is the primary means of generating notes and chords. It is also possible to connect an external MIDI controller. The grid pad layout is flexible and can be configured with a structure to suit the user. The pads are colored based on the representative Synth and are velocity-sensitive. The scale and root can be set per Synth on the pads. A collection of layout templates is provided for presenting 1, 2, or all 3 synths across the grid pads. A total of 8 voices are available across all 3 synths, each of which can be allocated a specific voice count depending on its application. One unique feature of Synth is the application of chords. Several chord models are available, including chord packs where a library of custom

chords can be used with Synth. These are managed through the application of chord packs. This expands the possibilities for live play and ad-libs as well as sound designs. Chord pack chords can even be edited using the on-board editor. Note that synth also has a sequencer and arpeggiator, which can also drive the note and chord application, and these functions are covered in a dedicated section of this manual.

4 Notes & Chords

4.1 Grid Layout

Synth user interface is based in a 5 x 12 pad grid which is used for playing synth presets. The grid is customisable to match your preferred style and also to take advantage of using all 3 synth engines at the same time. The synths, modes, chords, scales and root notes are configurable.

Configuring the grid

Configuration is found in the main menu, under the grid options. The main menu is accessed with the screen knob. The grid settings are saved with the scene.



Press the (Screen) knob to open the main menu. Turn (Screen) to scroll and navigate the menu. Press (Screen) to select a highlighted option or sub-menu.

Turn to highlight 'Grid' - press (Screen) knob to select.

The [Screen] buttons can be used to navigate back up in the menu or to change pages.

C1, C2, C3 knobs edit the generic settings.

Grid			
C1	Layout Florida	Mode Note	Mode Note
C2	Scale Chromat	Chord -	Chord -
C3	Root C	Root C1	Root C1

The 9 Macro knobs change the displayed parameter values.

Grid		
Mapping Wrap	Mapping Wrap	Mapping Row +1

Synth 1 - Blue Vertically orientated Synth 2 - Yellow Vertically orientated Synth 3 - Purple Vertically orientated

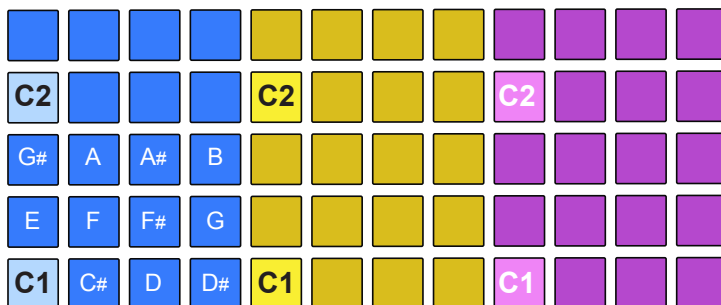

Root
e.g. C, octave can be set per synth note C1, note C2 etc. Pad is brightly lit.

Scale
e.g. Chromatic, pads represent all notes in the selected scale.

Pads are lit white while playing notes. If a synth is set to a chord mode and another synth set as a follower, the pad for last chord played will be lit red.

Grid layout

The layout format for the 3 synths can be selected in the grid sub-menu of the main menu. The selected layout is saved with the scene. Grid colors can also be changed in the settings.

Layout Examples

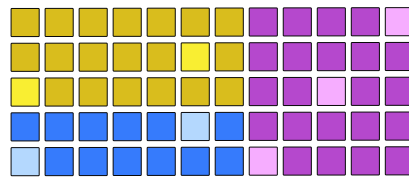

Florida man
All 3 Synths laid out across the grid pads.
Synths are organised in a mixed arrangement.
This is the default layout.

■ Synth 1. ■ Synth 2. ■ Synth 3.

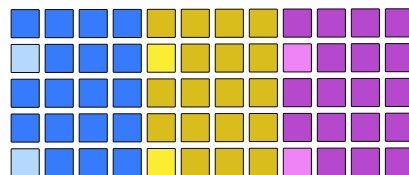

3 x 3
All 3 Synths laid out across the grid pads.
Synths are organised in a vertical arrangement.

■ Synth 1. ■ Synth 2. ■ Synth 3.

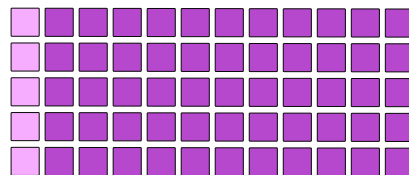

Purple
A single synth laid out across all of the grid pads. Synths notes are organised in a horizontal arrangement.

■ Synth 1.

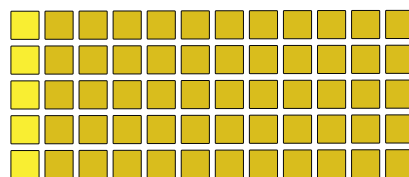

Yellow
A single synth laid out across all of the grid pads. Synths notes are organised in a horizontal arrangement.

■ Synth 2.

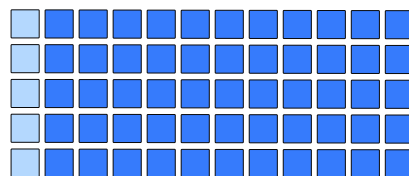

3 in 1
The grid option for 3 synths to played from one grid is available in the layouts. Also the option to use 2plus1 to play 2 synths in the pad group. These can only be played in note mode.

■ Synth 1. ■ Synth 2. ■ Synth 3.

■ ■ ■ To change the grid pad colors, Press (Screen) and select System Settings > Colors - adjust each synth color scheme as desired.

The parameters available to edit will depend on the layout. If only one synth layout is selected then only the parameters for the selected synth are presented on the display and therefore accessible to edit.

4 Notes & Chords

Grid mapping

Notes played on the pads will depend on the grid layout and the mapping. Wrap will lay notes out bottom left to right in note order of the scale and will continue up each row. Row+X will lay notes bottom left to right in note order for the first row and then will increment per column in X semitones. This setting is found in page 2 of the grid settings.

Examples

Wrap:
Synth 2 - Yellow - 'Florida Man' Layout
Chromatic scale - Root C, Wrap.

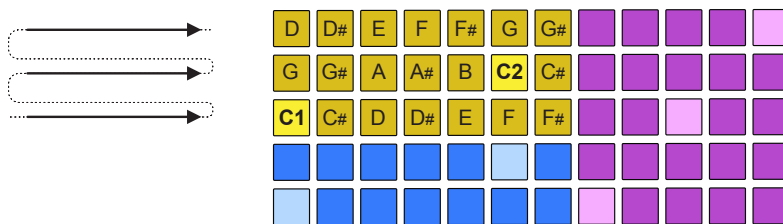

Row+1:
Synth 2 - Yellow - 'Florida Man' Layout
Chromatic scale - Root C, +1 Semitone.

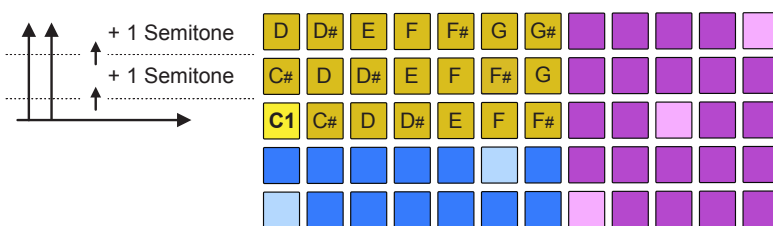

The 'Row' option offers a semitone offset range of +1 to +11 increments up per row within each column based on the selected scale and root.

Grid behavior:

The grid pad sensitivity and aftertouch behavior can be adjusted. These are found in the system settings. See the system section for details. Also the grid and the display can be visually dimmed using the system menu setting.

Grid page settings accessed in the main menu, under the 'Grid' options. Press (Screen) knob to open the main menu and turn the knob to navigate.

Option	Global / Synth	Knob	Description
Layout	Global	C1	Select from a collection of available pad layouts; Florida Man, 3X3, By The Lake, New Flag, The Big One, 5050 Sheet, The Truck, 5050 Bottom, The Beach, Blue, Yellow, Purple.
Scale	Global	C2	Chromatic, Minor, Major, Dorian, Lydian Major, Lydian Minor, Locrian, Phrygian, Phrygian Dominant, Mixolydian, Melodic Minor, Harmonic Minor, BeBop Major, BeBop Dorian, BeBop Mixolydian, Blues Minor, Blues Major, Pentatonic Minor, Pentatonic Major, Hungarian Minor, Ukrainian, Marva, Whole Tone, Diminished, Super Locrian, Hirajoshi, In Sen, Yo, Iwato, Kumoi, Overtone, Double Harmonic, Indian, Neapolitan Major, Neapolitan Minor, Enigmatic.
Root	Global	C3	C, C#, D, D#, E, F, F#, G, G#, A, A#, B.
			Note.
			Ch Scale.
Mode	Per Synth	Param 1, 2, 3	Follower. Only available if another synth is set to a chord option. Chord. Ch Pack. Custom chord packs.
Chord	Per Synth	Param 4, 5, 6	Selects the chord types when a chord mode is selected or selects from the library of custom chord packs. Chord types available (see below); None, Pow4th, Pow5th, Minor, Major, Dim, Aug, Sus2, Sus4, Maj7, Min7, Dom7, Min7b5, Maj6, Min6, MinMaj7, Maj9, Min9, Maj11, Min11, Maj13, Min13.
Root	Per Synth	Param 7, 8, 9	Sets the root note octave range for each synth between C0-C8. The default is C1. Also this can be changed using a shortcut by pressing [Screen] for a selected synth + turn (Screen) knob when in a synth display page.
Mapping	Per Synth	Page 2 Param 1, 2, 3	Wrap maps notes bottom left to right and continues in order up the rows. The row+ option will map the first bottom row left to right in note order and also increment up each pad per row in semitone increments as defined in row+ i.e. row+1 is 1 semitone.







Polyphony:

Remember to configure a synth's voices when using chords. For example a triad would need 3 voices to play the chord. This setup is in the main menu under 'Synths'.

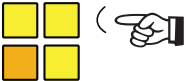
4 Notes & Chords

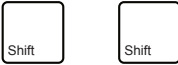
4.2 Playing Notes on the Grid

The pads will be lit to represent the colour for each synth. Synth 1, Blue, Synth 2, Yellow and Synth 3, Purple. The root notes will also be identified for each pad. All pads will represent a note based on the scale and octave range selected for each synth.

- To play a note or chord  Press the [Pad] or pads for the notes to play. The polyphony played will be based on the voice settings.
- To play & sustain notes / chords  Hold [Shift] + press the [Pad] or pads for the notes to play or to release a single note. Pads are velocity sensitive so the pressure applied will affect the output sound.
- To release sustained a note  Double tap [Shift] to release all sustained notes. Also to release only specific notes, Hold [Shift] + press the [Pad] or pads.
- To apply velocity while playing  Press the [Pad] or pads. Pads are velocity sensitive so pressure applied will affect the output sound volume level. The pad colour shade will initially change to reflect the velocity applied.
- To apply aftertouch while playing  Press the [Pad] or pads. Aftertouch or pressure can be continually applied after initially pressing a pad. The aftertouch settings and macro will determine what parameter is affected. The pad colour brightness will also change to reflect the pressure applied.
- Note orientation  The pad colours represent the notes in the synth's scale. The alternate coloured pads represent the root note. Example, Synth 1 is yellow pads with an orange pad defining the root note.

All Notes Off:

The option to reset and clear any hanging notes can be performed from within the main menu. Press (Screen) knob and scroll to the 'All Notes Off' menu option. Press (Screen) to activate.

4.3 Polyphony & Voices

Synth is a multi-engine polyphonic synthesizer. Polyphony is the ability to play multiple notes at the same time, each generating its own pitch. For example playing a chord. Polyphony is implemented using voices. A voice is a discrete audio channel. Voices are allocated in Synth using the 'Synths' option in the main menu where a maximum of 8 voices can be allocated across the 3 synth slots.

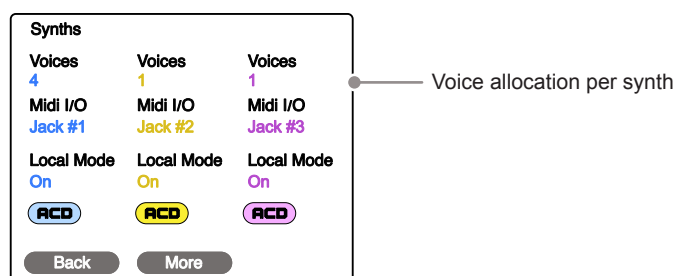

SETTING UP SYNTH VOICES

1. Determine the use for each synth. For example, a bass synth may be ok with 1 voice to operate a monophonic synth. A melody with triad chords will require 3 voices and so forth. The GRAIN Synth engine has a paraphonic mode option allowing chords to be played with one voice.
2. Open the main menu. Hold (Screen) knob to select the main menu and turn (Screen) to navigate through the options.
3. Highlight the 'Synths' option and press (Screen) to select. The synth's page will open.
4. The 9 touch rotary knobs are used to edit the 9 parameters on the page. The top row of knobs are used to change the voice count for each of the 3 synths. Set the value to suit the application of each synth. A maximum of 8 voices can be allocated in total for all 3 synth's.
5. The allocation of voices as well as the other synth options in the 'Synths' page are saved with the scene.

CPU performance:

Try to keep the voice count as low as needed to help CPU performance. Each voice whether playing or not will increase CPU loading.

4 Notes & Chords

4.4 Chords & Smart Grid

The grid page, found in the main menu, offers a number of options to set how the grid will be used to play back notes or chords. The smart grid function ensures the three synths can be played musically together. Custom chords are available as chord pack presets. These options are available in the 'Mode' options for each synth when in the grid page.

Select grid option from the main menu



Press the (Screen) knob to open the main menu. Turn (Screen) to scroll and navigate the menu. Press (Screen) to select a highlighted option or sub-menu.

Turn to highlight 'Grid' - press (Screen) knob to select.

Grid

Layout	Mode	Mode	Mode
Florida	Follower	Chord	Note
Scale	Chord	Chord	Chord
Major	-	Major	-
Root	Root	Root	Root
C	C3	C3	C1

Back More

Chord options

- Note or chord modes per synth
- Chord scale

Grid

Layout	Mode	Mode	Mode
Florida	Follower	Ch Pack	Note
Scale	Chord	Chord	Chord
Chroma	-	Bay City	-
Root	Root	Root	Root
C	C1	C1	C1

Back More

Chord packs

- The 'Ch Pack' mode
- A chord pack preset

Mode	Description
Note	Plays only the individual notes from a single pad. Pressing multiple pads can play multiple notes as a chord manually if the voice count allows.
Chord	Allows individual pads to play as a chord as opposed to a note. This is the leading chord synth. Only one synth can be assigned to a chord mode and the others can be set as followers to this scale or remain as note pads.
Ch Scale	Allows individual pads to play as a chord within the selected scale. This is the leading chord synth. Only one synth can be assigned to a chord mode and the others can be set as followers to this scale or remain as note pads.
Ch Pack	Enables access to a selection of chord presets. These are selected using the 'Chord' option when in chord pack mode.
Follower	This option is only available if another synth is set to a chord mode. The synths where this option is applied will automatically adapt the notes presented on the pads to match the chord scale.

The synth pads can be setup not only to play generic chords, but also to play a group of specifically assigned chords. This allows a selection of chords for progressions and melodies to be used with the pads. These custom chords are called chord packs and are stored on the microSD card and are not saved with the scene.

Chord pack example

A chord pack size of 8 chords

F Major
C-F-A

C Major
C-E-G

F Major
C-F-A

G Major
D-G-B

C Major
C-E-G

D Major
D-G-B

A Minor
C-E-A

E Minor
E-G-B

Select first pad
Root note: C3

Next pad, assign another chord.
Root note: G2
Chord: Major

Smart grid, follower - chord mode

With the smart grid, you can play 3 Synths independently in note mode or use chords intelligently to link synths scales. These options are available in the grid settings. You can set one synth to operate chords and the other two synths to operate as chord followers. Therefore, the 'follower' synth grid notes are influenced by the chord mode synth. Playing chords will automatically and musically synchronize the manually played or latched notes on the follower synths based on the scales. The lead synth will show the last selected pad lit red when acting as the lead chord synth.

Chord mode follower is a great feature for live performances. It allows you to play multiple engines harmoniously and keeps ad-libs and improvisations musical.

4 Notes & Chords

Chord pack editor

NOTES

Chords in a chord pack can be individually configured using the chord pack editor. This is accessible in the grid page. A chord can then be created for the selected pad starting with the default settings of C Major and be combined into a chord pack size of, say 8.

Summary of Options

Chord Packs are not saved with the Scene.

Option	Description
Grid root	Root note for the scale.
Chord Root	Root note, including octave value for the pad. Also shown on main grid page. [-] Indicates notes not contained in the selected scale.
Chord	Chord assigned to the pad. [-] Indicates chords not contained in the scale.
Grid Scale	Minor, Major, Dorian, Lydian Major, Lydian Minor, Locrian, Phrygian, Phrygian Dominant, Mixolydian, Melodic Minor, Harmonic Minor, Hungarian Minor, Ukrainian, Marva, Super Locrian, Overtone, Double Harmonic, Neapolitan Major, Neapolitan Minor, Enigmatic.
Spread from	Starting, lower note in the chord played.
Spread to	Ending, upper note in the chord played. The chord is spread across the range.
Pack Size	Number of chords in the chord pack. Each chord is represented by a grid pad. Up to 12 chords are available in each pack
Flw Scale Size	Maximum number of notes in the scale.

Example Chord Pack Configuration

Synth 2 - Yellow
Vertically Orientated

Start by setting Pack size for number of chords to create. Select a pad, then set the Root Note and the Chord.

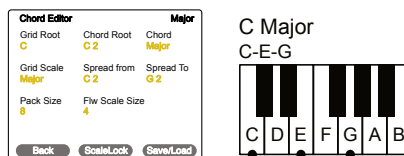

[-] Indicates notes / chords not in the scale

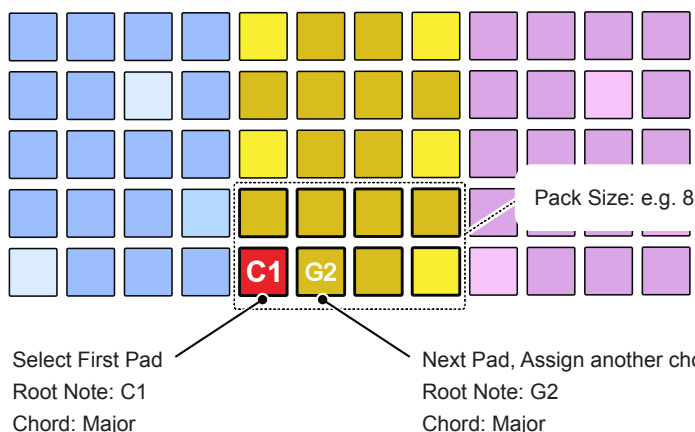

Creating chord pack

When editing chords it is important to follow the button commands plus the menu navigations in the order stated. Start by opening the grid menu while holding the button combo. Chord packs can also be loaded from the library.

1. Select a synth.

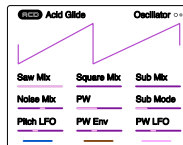

Press one of the synth screen buttons

2. Open the 'Grid' menu. Press (Screen) to open settings.
3. Select Chord Pack from the grid page

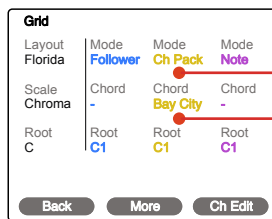

Select for any one of the Synths

The 'Ch Pack' Mode

A Chord Pack Preset

4. Select a grid pad chord to edit



5. Open the chord editor

While in the grid page with 'Ch Pack' mode active as shown above, Press [Ch Edit] screen button. Only active when chord pack and pad is selected.

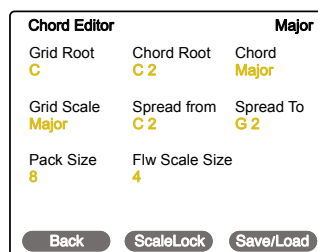
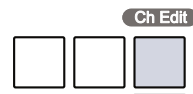

The option to initialise and create a default chord pack to edit is possible from within the Save/Load menu. Alternatively edit the current chord pack.

Use the parameter knobs to edit each option.

Scale lock can be used to lock the chord and root note to the scale root, example to C.

6. Save the Chord Pack

Press [Save/Load] to save an edited chord pack. Also the option to initialise a new pack template is possible as well as loading a pack from the library

5

Synths

At the heart of Polyend Synth is a collection of 8 synth engines, each with a unique style and character. The synth engine is hosted in a preset that contains a set of parameters that are specific to each engine. 3 Preset instances can be loaded and controlled simultaneously, each with the same or a combination of synth engines. The configurations of filters, envelopes, and LFOs will depend on the synth engine loaded and the parameter settings based on the specific preset. A blank preset can be initialized to get things started with a default state if required. The synth engines range from traditional single and multiple oscillators, as well as subtractive models such as ACD and VAP, to WTFM, which is a unique spin on the FM

synthesis design. Granular, wavetable, and phase distortion synthesis engines are also included in the available engine models. In addition to the synth engine, a filter, envelopes, and modulation can also be applied to create a full synth voice. These functions are also configured as part of a synth preset. An additional feature for synth control is the macro function which consists of 3 dedicated control knobs, each of which is configured to control a collective set of parameters. This enables dynamic changes and modulation of these parameters on the fly. This section covers the basic creation of synth presets, each of the synth engines and its parameters, the associated filter configurations, and the envelopes. These are all contained in the preset.

5 Synths

5.1 Synth Engine Overview

A collection of synth engines are available, each with a different style and character.

ACD™ ACD transports you back to the golden age of electronic music with its recreation of iconic single-oscillator monophonic analog synths. Paying homage to Japanese legends, ACD not only captures the essence of these classics but also propels you into the future with a lightning-fast synthesis experience. It offers a rich palette of options, ranging from faithful monophonic analog recreations to entirely unique and innovative soundscapes.

FAT™ FAT is a powerhouse synth engine that epitomizes the lush, vintage warmth of classic analog synthesizers. At its core, FAT hosts three virtual analog oscillators and offers an intuitive drift and detune control, ensuring you can effortlessly sculpt iconic massive sounds. The presets contain two distinct flavors of ladder filters inspired by two unique analog classics. It offers a versatile range of sounds, from deep reese basses to ethereal pads, expressive leads and classic keyboards.

VAP™ VAP is a virtual analog polysynth, boasting a dual-oscillator architecture and a versatile modulation matrix. Complete with multiple filter flavors and pulse width modulation, VAP allows you to sculpt intricate patterns. This engine shines when it comes to creating mesmerising, evolving textures, crafting lush pads, and conjuring up one-of-a-kind sound effects.

WTFM™ WTFM is a unique 2-operator FM synth engine that utilized wavetable based oscillators driven by a 3x feedback system. The operators are based on sweeping wavetables, ranging from fundamental sine waves to harmonically rich timbres, offering a diverse tonal palette. Whether you're sculpting smooth, enveloping pads or crafting cutting-edge metallic tones, WTFM empowers you to achieve unique textures with precision and authenticity.

PHZ™ With PHZ classic phase distortion tones or experimental new sounds are possible. PHZ consists of 2 oscillators with varying shapes and unlike classic phase distortion synths, filters and a Polyend style mod-matrix have been included. The phase of an input waveform is distorted by functions/methods. Each of these functions can be gradually modulated by parameters X and Y ranging 0 ~ 1.

PMD™ Classic Physical modelling synthesis with unique controls and modulation options. Timbre controls the sound in a way specific to each generator. Mallet and Air Flow are specific parameters for each generator. The Exciter envelope should not be treated as an equivalent of amp envelope in a traditional synth - it's behavior has different effect on each generator (does not affect Strike at all). The Resonator further shapes the mixed sound of the generators.

WAVS™ Wavs is a unique wavetable synthesizer engine which plays and morphs between two wavetable oscillator samples while applying filtering. Wavetables are stored in plain WAV files in the Samples > Wavetables folder. Control of Position controls the scanning while it interpolates between the WAVs. Warp affects the the oscillator phase, stretching or warping from the centre to the edge of the sample point. This operates in a positive or negative dimension.

GRAIN™ Grain is a granular synth engine which takes a standard WAV sample file and generates a series of audio fragments called grains. The generation of the grains such as size, density and shape can be controlled as well as how these are scanned and played back, for example scanning position and direction. The cloud and burst features control how grains are generated, continuously or in cyclic batches of grains. Grain pitch can be played in paraphonic mode as chords.

DWA™ DWA is a dual wavetable architecture synthesizer, with an experimental approach to sample-based synthesis. Each DWA patch uses two samples that can be cross-mixed, looped and manipulated in various ways. Tight control of the sample playback allows for single cycle waveforms, mangled loops, or randomized snippets. Transform simple samples into extraordinary sounds.

midi The MIDI Instrument is also available in the synth engine presets. The MIDI Instrument allows CC configurations to be created, saved, and loaded, building a library of MIDI control change presets.

DIRT™ A synth designed for waveshaping, warping, and creating massive basslines, glitchy textures, or gritty lo-fi pads. Warp a core oscillator, mix in a sub with a dedicated low pass filter, and choose from 13 waveshaper modes that combine shaper modulation control, flexible filter routing, and gain staging. Dirt provides a massive palette of overdriven timbres.

5.2 Synth Preset Overview

Synth has 3 synthesizer slots each of which contains a synth preset. A preset defines the precise sound based on its assigned engine and associated parameter settings. One preset can be loaded into each synth slot. A preset can be created and edited or loaded from the factory library.

3 Synth slots are available. Each slot can be assigned one of the synth engines

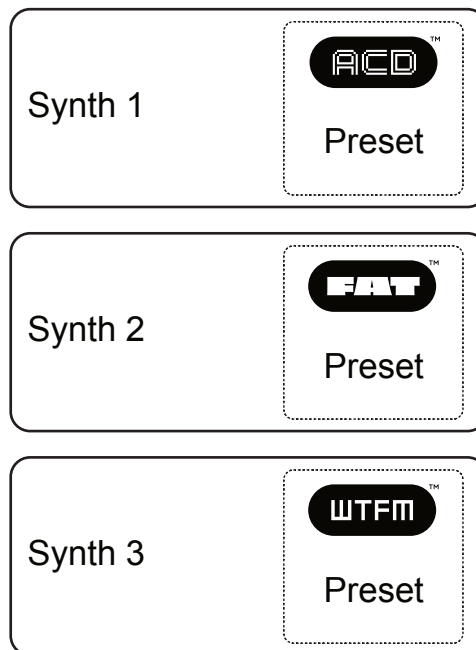

The synth engine plus its parameter settings contribute to the preset.

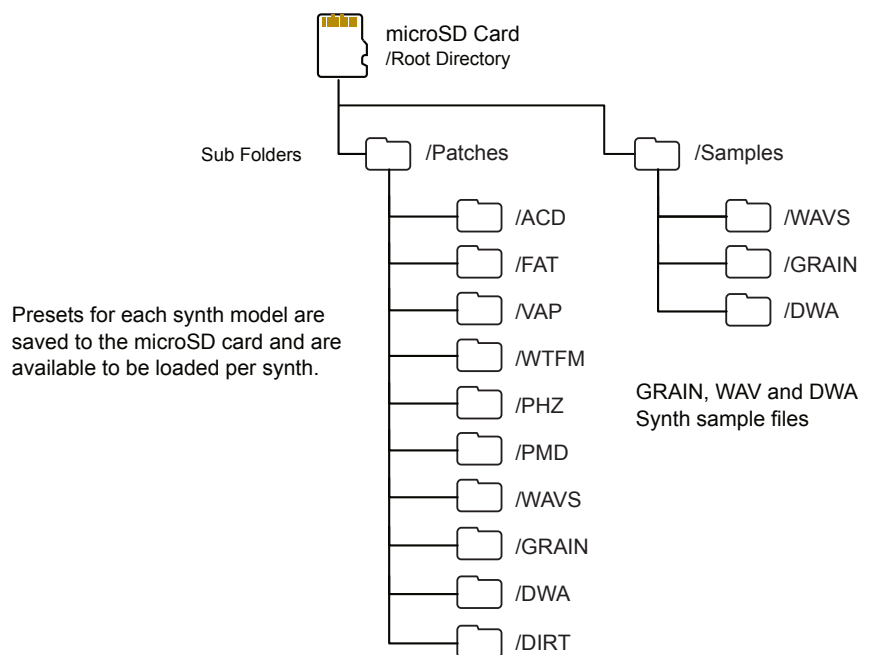

Presets for each synth model are saved to the microSD card and are available to be loaded per synth.

GRAIN, WAV and DWA Synth sample files

5 Synths

5.3 Synth Parameter Options

NOTES

The parameter set available for sound design within the synth preset will depend on the synth model applied. As the synth engine models are all different, the parameters will vary significantly. The synth parameter buttons will allow quick access to the parameter sections.

Oscillator and primary sound source

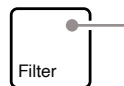
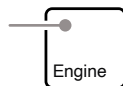

Filter orientated parameters

Envelope section, typically amp & filter

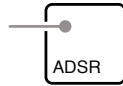

Low frequency oscillator 1 & 2 options

Tap button to select the function and continue to tap to cycle through all the available pages for the selected function. Pages and parameters will vary depending on the current engine selected.

5.4 Synth Selection & Configuration

Selecting a synth for a chosen slot is performed in the 'Preset' option accessed with [Shift] + [Preset]. In this browser, a synth can be selected to use or edit. Configuring a synth is based on either choosing a synth engine preset for editing or initializing a synth engine to start afresh and edit the synth from a default state. The latter option is used to initialize and create new presets.

SELECTING A SYNTH PRESET

1. Ensure the scene in which to work is open and active. If a new scene is initialised this will automatically apply 3 ACD synth engines as defaults to the synth slots.
2. Select any of the 5 right side synth parameter options i.e. Press [Engine]. The device will represent the synths as:-
 - The lower part of the display will show 3 coloured bars, each representing a synth slot. Blue - Synth 1, Yellow - Synth 2 and Purple - Synth 3. The screen buttons represent these synths.
 - The parameter values will also reflect this same colour scheme for the selected synth.
 - The pads will be arranged in zones which reflect the synths. The synths are shown by colour and the arrangement can be changed in the main menu grid settings.
3. In a synth parameter page, the 3 Display screen buttons can be used to select a Synth. For this example, press the left side 'Blue' button to select [Synth 1] for editing.

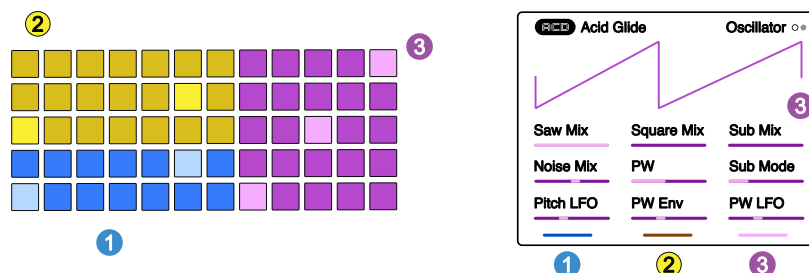

Grid pad and the synth parameter colours represent the specific synth slot 1, 2, 3.

5 Synths

4. Select a synth preset from the library. Navigate menu options by turning (Screen) and select menu options by pressing (Screen) knob.
 - Hold [Shift] + press [Preset] to open the preset browser.
 - Press [*Engines*] screen button to browse the engines. Turn to navigate and then press (Screen) knob to select the engine and list the presets available.
 - To choose an existing preset, turn (Screen) to browse and press (Select) knob to select a preset.
 - To create a new preset, press [*Init*] screen button to open a default state synth for the engine selected.

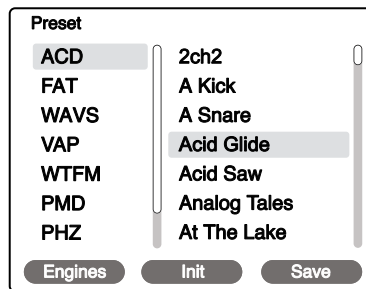

While each synth preset can be edited to design a sound per synth, a set of general 'Synth' configurations is also available in the main menu, which should be considered at the outset, especially the polyphony option explained earlier.

Sound design is an iterative process involving parameter adjustments and tweaking by ear. These steps cover the basic editing process.

■ EDITING SYNTH PARAMETERS FOR SOUND DESIGN

1. Ensure the scene in which to work is open and active and a specific synth selected for editing.
2. Pages are laid out with up to 9 parameters, each controlled from the equivalent knob from the 9 unlabelled touch sensitive knobs.
3. To trigger a sound, press [Pad] for the specific synth. To lock a sound on or to release a locked sound pad, hold [Shift] + press [Pad]. Double tap [Shift] to clear all locked pads. Multiple pads can be triggered and the sounds generated will be based on the polyphony of the synth. It is often useful to lock a sound when editing.
4. A good optional tip to get started is to ensure the filter is off, Select [Filter] and turn (Cutoff) knob clockwise until 'Off'. This will deliver a full sound, unfiltered as a good starting point.
5. The typical starting point is the synth engine itself. Press [Engine] to open the page and access the oscillators and sound generation functions and parameters. Each press of [Engine] cycles through the available pages.
6. Adjust the desired parameter using the touch sensitive knobs to tweak and tune the oscillator or sound generator. This will be based on the engine selected. See the synth data sheets for specific parameter details.
7. The filter can be revisited through the iterative process, as can the two ADSR envelopes which control the filter and amp volume output. While setting up the envelopes, consider triggering the pad note pad should manually rather than lock the note. This will ensure the attack, decay, sustain and release stages can be heard.
8. Save the sound as a preset. Hold [Shift] + press [Preset] to open the browser. To 'Save As', hold [Shift] + press [Save As] screen button. The naming window will allow a name to be created. To 'Save', simply press [Save] to save / overwrite into the existing preset name.

5 Synths

5.5 ACD Synth Voice

NOTES

ACD™ ACD is a single-oscillator monophonic analog synth and has the simplest parameter set of any of the Synth engines in the library. Inspired by classics such as the SH101 and TB303, this would be the go-to synth for lead lines and arpeggiated melodies or simple bass lines. The synth voice preset using the ACD Engine consists of a single oscillator with variable pulse width and pitch, 2 envelopes (amp and filter) and an LFO.

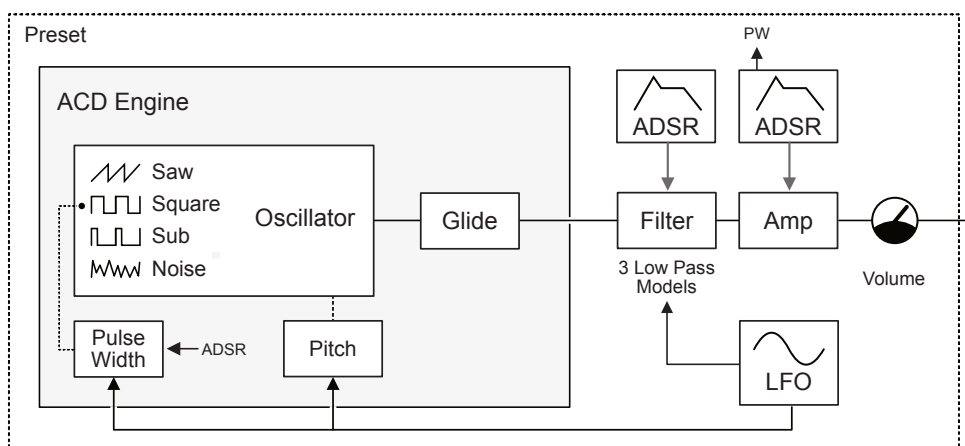

Engine Oscillator - Page 1

Saw Mix	Square Mix	Sub Mix
0-100%	0-100%	0-100%
Amount of saw wave oscillator	Amount of square wave oscillator	Amount of sub oscillator
Noise	PW	Sub Mode
-100 to +100%	0-100%	Options
Amount of noise applied	Pulse width of the square wave.	Sub oscillator options for square, pulse and triangle waves -1 or -2 octaves below the main oscillator
Pitch LFO	PW Env	PW LFO
0-100%	0-100%	-100 to +100%
Amount of the LFO modulation applied to the oscillator pitch.	Amount of amp envelope applied for the pulse width	Amount of the LFO modulation applied to the oscillator pulse width i.e. pulse width modulation.

Engine Oscillator - Page 2

Glide Mode	Glide Time	Volume
Options	0.00 - 3 Secs	0-200%
Slide between notes: Always, Overlap, Legato i.e. Envelopes are not triggered, Legato Overlap	Time of slide between notes.	Volume level of oscillator voice



Filter - Page 1

Cutoff	Resonance	Type
Frequency: 20Hz - 20kHz	Amount: 0-150%	Filter Model
Frequency point at which the audio is attenuated. Can also be set to off.	Emphasises the frequencies at the cutoff position.	Low Pass SV12, Low Pass SV 24, Low Pass RD 3.
Envelope Amount		Note Track
Amount: -100% to +100%		Amount: -200% to +200%
Amount of envelope applied to the filter cutoff.		Amount of modulation applied based on the pitch of the note played.
Filter LFO		Note Track
Amount: -100% to +100%		Amount: -200% to +200%
Amount of LFO applied to the filter cutoff.		Amount of modulation applied based on the pitch of the note played.

Envelope Amp - Page 1

Attack	Decay	Sustain
Time: 0.00-10 Sec	Time: 0.00-10 Sec	Level: 0.00-100%
Amp envelope attack time. Time for audio to reach max level.	Amp envelope decay time. Time between max time to the sustain level.	Level of audio sustained while note is still on.
Release		
Time: 0.00-10 Sec		
Amp envelope release time. Time from note off to silent.		

Envelope Filter - Page 2

Attack	Decay	Sustain
Time: 0.00-10 Sec	Time: 0.00-10 Sec	Level: 0.00-100%
Filter envelope attack time. Time for audio to reach max level.	Filter envelope decay time. Time between max time to the sustain level.	Level of audio sustained while note is still on.
Release		
Time: 0.00-10 Sec		
Filter envelope release time. Time from note off to silent.		

5 Synths



NOTES

LFO 1 - Page 1

Frequency	Waveform	Retrigger
0-100 Hz	Options	Options
Speed of the LFO	Modulation wave shape: Triangle, Sin, Ramp Up, Ramp Down, Square, Random S&H	Waveform retrigger: Free running will continuously run; One Shot will cycle once when a note is triggered; Note will trigger from the start and continuously run each time a note is triggered.

5.6 FAT Synth Voice



FAT is a 3 Oscillator subtractive synth engine which offers thick sounds ideal for big leads, lush soundscapes, pads, drones and bass. The virtual analog model includes vintage ladder style filters ideal for interesting and expressive leads

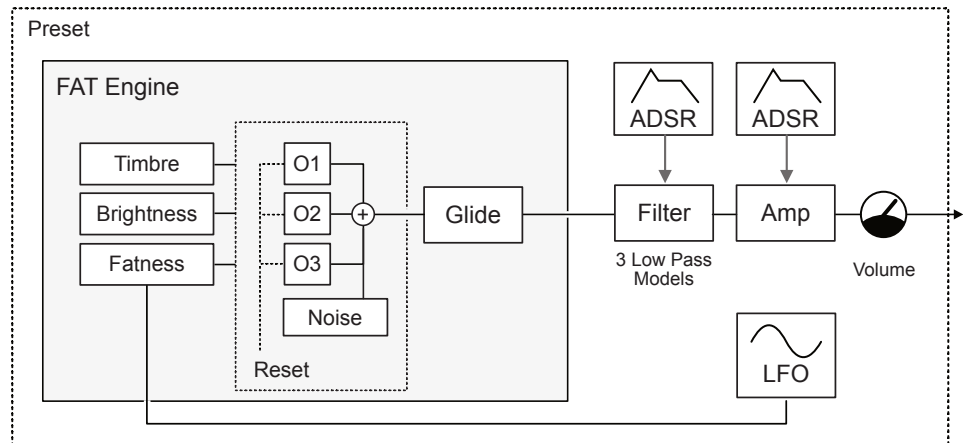

Engine Oscillator - Page 1

Fatness	Brightness	Timbre
0-100	-100 to +100	0-100
Affects the oscillator thickness / spread for style and character	Affects the oscillator EQ balance for brighter or darker sounds	Affects the oscillator timbre morphing between saw to square wave.
Fatness LFO		
0-100%		
Amount of LFO applied to the fatness of the oscillator.		
Noise	Reset	
0-100%	On - Off	
Amount of noise applied to the audio.	On, resets oscillator cycle on each note trigger.	

Engine Oscillator - Page 2

Glide Mode	Glide Time	Volume
Options	0.00 to 3 Secs	0-200%
Slide between notes: Always, Overlap, Legato i.e. Envelopes are not triggered, Legato Overlap	Time of slide between notes.	Volume level of oscillator voice



Filter - Page 1

Cutoff	Resonance	Type
Frequency: 20Hz - 20kHz	Amount: 0-150%	Filter Model
Frequency point at which the audio is attenuated. Can also be set to off.	Emphasises the frequencies at the cutoff position.	Low Pass MG 24, Low Pass OB 24, Low Pass OB 12. Classic filter emulations.
Envelope Amount		
Amount: -100% to +100%		
Amount of envelope applied to the filter.		
Filter LFO		
Amount: -100% to +100%		
Amount of LFO applied to the filter.		

Envelope Amp - Page 1

Attack	Decay	Sustain
Time: 0.00-10 Sec	Time: 0.00-10 Sec	Level: 0.00-100%
Amp envelope attack time. Time for audio to reach max level.	Amp envelope decay time. Time between max time to the sustain level.	Level of audio sustained while note is still on.
Release		
Time: 0.00-10 Sec		
Amp envelope release time. Time from note off to silent.		

Envelope Filter - Page 2

Attack	Decay	Sustain
Time: 0.00-10 Sec	Time: 0.00-10 Sec	Level: 0.00-100%
Filter envelope attack time. Time for audio to reach max level.	Filter envelope decay time. Time between max time to the sustain level.	Level of audio sustained while note is still on.
Release		
Time: 0.00-10 Sec		
Filter envelope release time. Time from note off to silent.		

NOTES



LFO 1 - Page 1

Frequency	Waveform	Retrigger
0-100 Hz	Options	Options
Speed of the LFO	Modulation wave shape: Triangle, Sin, Ramp Up, Ramp Down, Square, Random S&H	Waveform retrigger: Free running will continuously run; One Shot will cycle once when a note is triggered; Note will trigger from the start and continuously run each time a note is triggered.

5 Synths

5.7 WAVS Synth Voice

NOTES

WAVS™ WAVS is a 2 oscillator wavetable synthesizer. The wave stage output acting as the oscillator section. Wave file positions are scanned and the wave is stretched and morphed. The application of a filter stage also affects the audio output. Modulation of the warp and position can produce an interesting output.

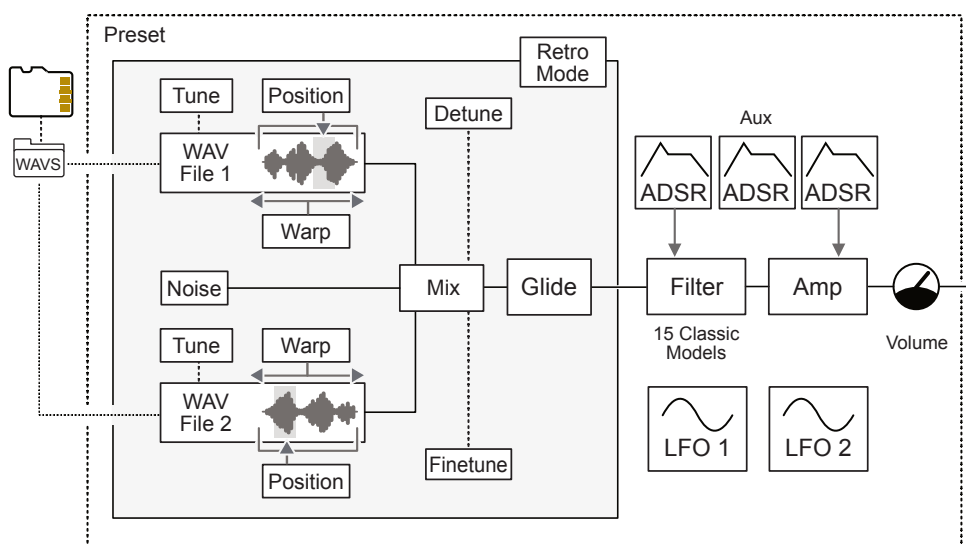

Engine Oscillator - Page 1

WAV File	WAV File	Retro Mode
Source Sample File	Source Sample File	On - Off
Wavetable 1 sample selected from the Samples/WAVS folder on microSD. Both wavetables are blended together and filtered.	Wavetable 2 sample selected from the Samples/WAVS folder on microSD. Both wavetables are blended together and filtered.	Changes character of synth
Position 1	Position 2	Mix
0-100	0-100	-100 to +100
Position in the wavetable	Position in the wavetable	Blended mix of wavetables
Warp 1	Warp 2	Noise
-100 to +100%	-100 to +100%	0-100%
Manipulates the phase to stretch and warp the audio wav.	Manipulates the phase to stretch and warp the audio wav.	Amount of noise applied



Engine Oscillator - Page 2

Tune 1	Tune 2	Detune
-36 to + 36 st	-36 to + 36 st	0-100 Cents
Oscillator 1 Tuning in semitones	Oscillator 2 Tuning in semitones	Oscillator mix detuning in cents
		Finetune
		-100 to +100 Cents
		Fine tuning of the mix in cents

Engine Oscillator - Page 3

Glide Mode	Glide Time	Volume
Options	0.00 -3 Secs	0-200%
Slide between notes: Always, Overlap, Legato i.e. Envelopes are not triggered, Legato Overlap	Time of slide between notes.	Volume level of oscillator voice

Filter - Page 1

Cutoff	Resonance	Type
Frequency: 20Hz - 20kHz	Amount: 0-100%	Filter Model
Frequency point at which the audio is attenuated.	Emphasises the frequencies at the cutoff position.	Low Pass MG 24dB, Low Pass OB 24dB, Low Pass OB 12dB, Low Pass SVF 24dB, Low Pass SVF 12dB, Hi Pass OB 24dB, Hi Pass OB 12dB, Hi Pass SVF 24dB, Hi Pass SVF 12dB, Band Pass OB 24dB, Band Pass OB 12dB, Band Pass SVF 24dB, Band Pass SVF 12dB, Notch SVF 24dB, Notch SVF 12dB,
Envelope Amount		Note Track
Amount: -100% to +100%		Amount: -200% to +200%
Amount of envelope applied to the filter.		Amount of modulation applied based on the pitch of the note played.



Envelope Amp - Page 1

Attack	Decay	Sustain
Time: 0.00-10 Sec	Time: 0.00-10 Sec	Level: 0.00-100%
Amp envelope attack time. Time for audio to reach max level.	Amp envelope decay time. Time between max time to the sustain level.	Level of audio sustained while note is still on.
Release		
Time: 0.00-10 Sec		
Amp envelope release time. Time from note off to silent.		

Envelope Filter - Page 2

Attack	Decay	Sustain
Time: 0.00-10 Sec	Time: 0.00-10 Sec	Level: 0.00-100%
Filter envelope attack time. Time for audio to reach max level.	Filter envelope decay time. Time between max time to the sustain level.	Level of audio sustained while note is still on.
Release		
Time: 0.00-10 Sec		
Filter envelope release time. Time from note off to silent.		

Envelope Aux - Page 3

Attack	Decay	Sustain
Time: 0.00-10 Sec	Time: 0.00-10 Sec	Level: 0.00-100%
Aux envelope attack time. Time for audio to reach max level.	Aux envelope decay time. Time between max time to the sustain level.	Level of audio sustained while note is still on.
Release		
Time: 0.00-10 Sec		
Aux envelope release time. Time from note off to silent.		



LFO 1 - Page 1

Sync	Frequency or Ratio	Waveform
On or Off	0-100 Hz or Intervals	Options
Set to Off for speed in frequency. On synchronises based on ratio of note interval divisions.	Speed of LFO in Hz or if Sync is on, in note interval ratios.	Modulation wave shape: Triangle, Sin, Ramp Up, Ramp Down, Square, Random S&H
Retrigger		
Options		
Waveform retrigger: Free running will continuously run; One Shot will cycle once when a note is triggered; Note will trigger from the start and continuously run each time a note is triggered.		

LFO 2 - Page 2

Sync	Frequency or Ratio	Waveform
On or Off	0-100 Hz or Intervals	Options
Set to Off for speed in frequency. On synchronises based on ratio of note interval divisions.	Speed of LFO in Hz or if Sync is on, in note interval ratios.	Modulation wave shape: Triangle, Sin, Ramp Up, Ramp Down, Square, Random S&H
Retrigger		
Options		
Waveform retrigger: Free running will continuously run; One Shot will cycle once when a note is triggered; Note will trigger from the start and continuously run each time a note is triggered.		

The Auxiliary Envelope and the two LFOs are not pre-patched into the WAVS engine by default. They can be patched in the Mod page.

Notes for user WAV files

Card Storage

Wavetables are stored in plain WAV files (16-bit mono, sample rate is not relevant) in the 'Samples/WAVS' folder of the microSD Card.

Wavetable Format

A wavetable file should contain one or more waves - each being a full oscillator cycle.

- Each wave should be aligned to a size that is power of 2 - typical sizes are 128, 256, 512, 1024, 2048. For instance, a wavetable with 5 waves of 256 samples will have $5 * 256 = 1280$ samples.
- The synth will automatically establish the number of waves in the file, but the size of the wave has to be given in its name, prefixed with a dash, for instance "epiano-1024.wav". If no number is provided in the name, a default of 256 is used.
- All factory waves are using 256 samples and so don't have a size in the name.

Wavetable Guidelines

- Do not add too many waves - usually 2, 3 or 5 is enough. The engine interpolates in between the waves so that the sound transitions smoothly. Using a long wavetable file will take more time to load.
- Be conservative with wave size. Usually 256 is optimum for high range of notes. For low bass with higher harmonics included you may want to go larger - up to 1024. But then the higher harmonics may cause aliasing if you play high. You want to keep the wave size close to typical frequency range for the sound, otherwise you risk aliasing at higher or lower notes (the synth uses interpolation).
- Examples:
 - C1 note = 32,7 Hz = full cycle fits in 1349 samples (so wave of 1024 samples is best fit).
 - C2 note = 674 samples
 - C4 note = 169 samples

5.8 VAP Synth Voice

VAP™ VAP is a dual oscillator virtual analog polysynth with some deep and interesting pulse width modulation options. Inspired by the OB-8 and Prophet, VAP is an ideal engine to use when shaping sounds and creating ambient textures or making complex patterns.

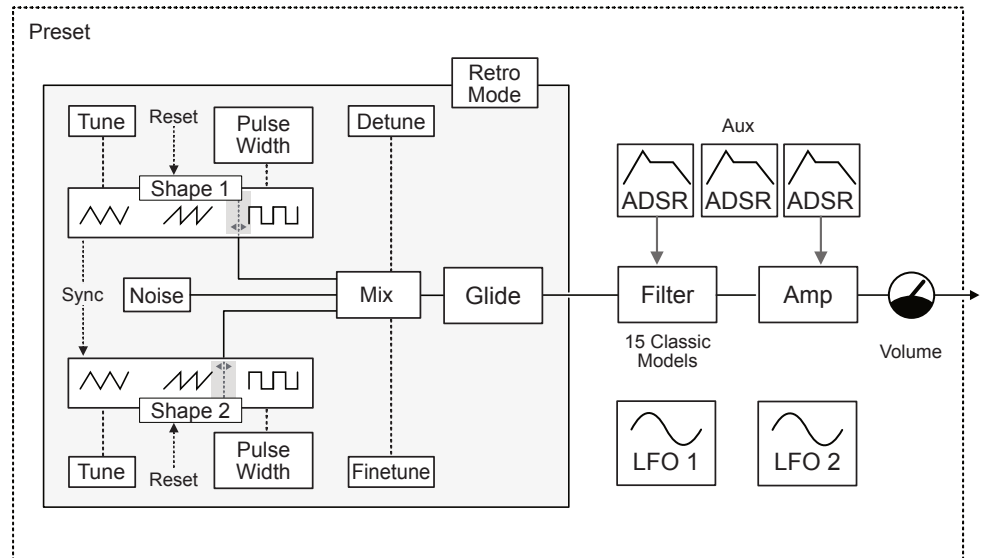

Patching options for the LFOs and envelopes are possible using the modulation function accessed using [Shift] + [Mod]. For PWM effects, the LFOs can be patched to the pulse width parameter.

Engine Oscillator Page 1

Shape 1	Shape 2	Mix
0-100	0-100	-100% to +100%
Oscillator 1 shape. Setting morphs between triangle, saw and square.	Oscillator 2 shape. Setting morphs between triangle, saw and square.	Oscillator 1 & 2 mix
PW 1	PW 2	Sync
-50 to +50	-50 to +50	On - Off
Oscillator 1 Pulse Width	Oscillator 2 Pulse Width	When set to On, Oscillator 2 resets on each cycle of Oscillator 1 (Osc 1 controls pitch).
Tune 1	Tune 2	Detune
-36 to + 36 st	-36 to + 36 st	0-100 Cents
Oscillator 1 Tuning in semitones	Oscillator 2 Tuning in semitones	Oscillator mix detuning in cents



Engine Oscillator - Page 2

Reset 1	Reset 2	Noise
On - Off	On - Off	0-100%
Oscillator 1 wave reset on note on, on or off	Oscillator 2 wave reset on note on, on or off	Adds noise into the audio
		Finetune
		-100 to +100 Cents
		Fine tuning of oscillator mix in cents

Engine Oscillator - Page 3

Glide Mode	Glide Time	Volume
Options	0.00 - 3 Secs	0-200%
Slide between notes: Always, Overlap, Legato i.e. Envelopes are not triggered, Legato Overlap	Time of slide between notes.	Volume level of oscillator voice

Filter - Page 1

Cutoff	Resonance	Type
Frequency: 20Hz - 20kHz	Amount: 0-100%	Filter Model
Frequency point at which the audio is attenuated.	Emphasises the frequencies at the cutoff position.	Low Pass MG 24dB, Low Pass OB 24dB, Low Pass OB 12dB, Low Pass SVF 24dB, Low Pass SVF 12dB, Hi Pass OB 24dB, Hi Pass OB 12dB, Hi Pass SVF 24dB, Hi Pass SVF 12dB, Band Pass OB 24dB, Band Pass OB 12dB, Band Pass SVF 24dB, Band Pass SVF 12dB, Notch SVF 24dB, Notch SVF 12dB,
Envelope Amount		Note Track
Amount: -100% to +100%		Amount: -200% to +200%
Amount of envelope applied to the filter.		Amount of modulation applied based on the pitch of the note played.



Envelope Amp - Page 1

Attack	Decay	Sustain
Time: 0.00-10 Sec	Time: 0.00-10 Sec	Level: 0.00-100%
Amp envelope attack time. Time for audio to reach max level.	Amp envelope decay time. Time between max time to the sustain level.	Level of audio sustained while note is still on.
Release		
Time: 0.00-10 Sec		
Amp envelope release time. Time from note off to silent.		

Envelope Filter - Page 2

Attack	Decay	Sustain
Time: 0.00-10 Sec	Time: 0.00-10 Sec	Level: 0.00-100%
Filter envelope attack time. Time for audio to reach max level.	Filter envelope decay time. Time between max time to the sustain level.	Level of audio sustained while note is still on.
Release		
Time: 0.00-10 Sec		
Filter envelope release time. Time from note off to silent.		

Envelope Aux - Page 3

Attack	Decay	Sustain
Time: 0.00-10 Sec	Time: 0.00-10 Sec	Level: 0.00-100%
Aux envelope attack time. Time for audio to reach max level.	Aux envelope decay time. Time between max time to the sustain level.	Level of audio sustained while note is still on.
Release		
Time: 0.00-10 Sec		
Aux envelope release time. Time from note off to silent.		



LFO 1 - Page 1

Sync	Frequency or Ratio	Waveform
On or Off	0-100 Hz or Intervals	Options
Set to Off for speed in frequency. On synchronises based on ratio of note interval divisions.	Speed of LFO in Hz or if Sync is on, in note interval ratios.	Modulation wave shape: Triangle, Sin, Ramp Up, Ramp Down, Square, Random S&H
Retrigger		
Options		
Waveform retrigger: Free running will continuously run; One Shot will cycle once when a note is triggered; Note will trigger from the start and continuously run each time a note is triggered.		

LFO 2 - Page 2

Sync	Frequency or Ratio	Waveform
On or Off	0-100 Hz or Intervals	Options
Set to Off for speed in frequency. On synchronises based on ratio of note interval divisions.	Speed of LFO in Hz or if Sync is on, in note interval ratios.	Modulation wave shape: Triangle, Sin, Ramp Up, Ramp Down, Square, Random S&H
Retrigger		
Options		
Waveform retrigger: Free running will continuously run; One Shot will cycle once when a note is triggered; Note will trigger from the start and continuously run each time a note is triggered.		

The auxiliary envelope and the two LFOs are not pre-patched into the VAP engine by default. They can be patched in the mod page.

5.9 WTFM Synth Voice

WTFM™ WTFM is an interesting frequency modulation - FM synth which uses integrated wavetables as its oscillators. The 2-operator FM synth engine is driven by a 3x feedback system.

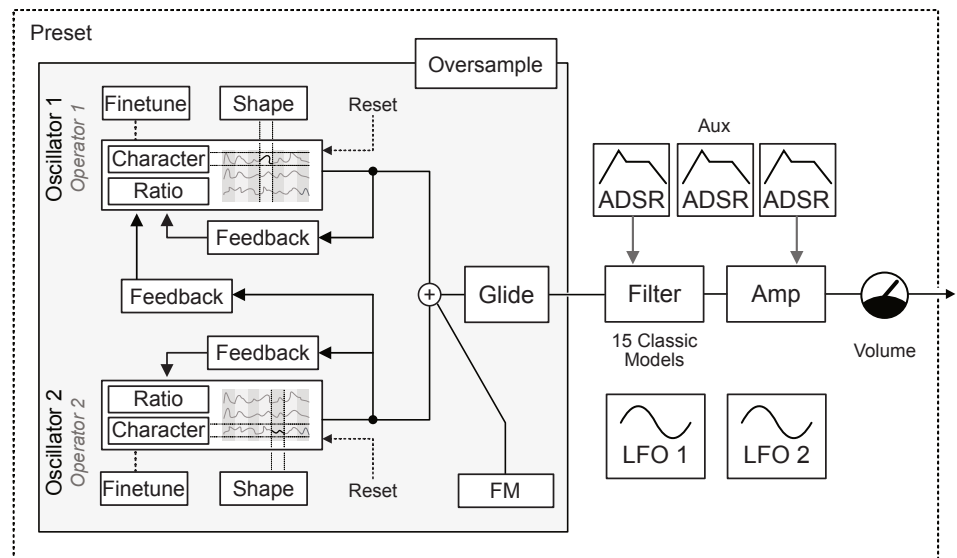

FM Concepts

At this stage, it is worth giving an overview of the core concepts of FM synthesis, which, at face value, can appear complex. An oscillator and associated functions and configuration in FM synthesis are called an 'Operator'. The terms operator and oscillator may be used interchangeably when referring to the WTFM synth engine. A WTFM operator uses wavetables as the audio source.

FM synthesis is based on the principle that one operator, called a modulator, affects the pitch of another, called a carrier. This changes the overall timbre of the sound. In Polyend Synth, the two operators generate audio and also provide feedback. In other words, the synth operators modulate themselves, with operator 2 being the modulator for operator 1, the carrier.

Ratios also multiply the incoming feedback audio with respect to the main carrier oscillator frequency to control the harmonic generation musically.

Traditional FM synthesis, sometimes referred to as a west coast synthesis model, does not use filtering. Filters are the normal domain for subtractive synthesis, sometimes referred to as east coast synthesis. However, Polyend Synth does include a filter in the audio chain to offer a more unique and interesting synth engine.



Engine Oscillator Page 1

Ratio 1	Ratio 2	FM
0.25 - 12	0.25 - 12	0% to +1000%
Oscillator 1 shape. Setting morphs between triangle, saw and square.	Oscillator 2 shape. Setting morphs between triangle, saw and square.	Overall frequency modulation application.
Shape 1	Shape 2	
0 to 100	0 to 100	
Oscillator 1 shape. Morphs horizontally across the wavetable wave row.	Oscillator 2 shape. Morphs horizontally across the wavetable wave row.	
Feedback 1	Feedback 2	Fdbck 2 to 1
0-100%	0-100%	0-100%
Amount of 'modulator' 1 audio fed back into the 'carrier' 1.	Amount of 'modulator' 2 audio fed back into the 'carrier' 2.	Amount of 'modulator' 2 audio fed back into the 'carrier' 1.

Engine Oscillator - Page 2

Finetune 1	Finetune 2	Oversample
-100 to +100 Cents	-100 to +100 Cents	On - Off
Fine tuning in cents of oscillator 1	Fine tuning in cents of oscillator 2	Turns oversampling on or off in the algorithm. On may give a higher quality output but increase CPU usage.
Character 1	Character 2	
Options	Options	
Selects wavetable row. Refers to type of shape. Smoother, Sharper, Wilder, Add 1, Add 2, Add 3, Add 5, Add 7, Add 11.	Selects wavetable row. Refers to type of shape. Smoother, Sharper, Wilder, Add 1, Add 2, Add 3, Add 5, Add 7, Add 11.	
Reset 1	Reset 2	
On - Off	On - Off	
Oscillator 1 wave reset on note on, on or off	Oscillator 2 wave reset on note on, on or off	

Engine Oscillator - Page 3

Glide Mode	Glide Time	Volume
Options	0.00 - 3 Secs	0-200%
Slide between notes: Always, Overlap, Legato i.e. Envelopes are not triggered, Legato Overlap	Time of slide between notes.	Volume level of oscillator voice



Filter - Page 1

Cutoff	Resonance	Type
Frequency: 20Hz - 20kHz	Amount: 0-100%	Filter Model
Frequency point at which the audio is attenuated.	Emphasises the frequencies at the cutoff position.	Low Pass MG 24dB, Low Pass OB 24dB, Low Pass OB 12dB, Low Pass SVF 24dB, Low Pass SVF 12dB, Hi Pass OB 24dB, Hi Pass OB 12dB, Hi Pass SVF 24dB, Hi Pass SVF 12dB, Band Pass OB 24dB, Band Pass OB 12dB, Band Pass SVF 24dB, Band Pass SVF 12dB, Notch SVF 24dB, Notch SVF 12dB,
Envelope Amount		Note Track
Amount: -100% to +100%		Amount: -200% to +200%
Amount of envelope applied to the filter.		Amount of modulation applied based on the pitch of the note played.

Envelope Amp - Page 1

Attack	Decay	Sustain
Time: 0.00-10 Sec	Time: 0.00-10 Sec	Level: 0.00-100%
Amp envelope attack time. Time for audio to reach max level.	Amp envelope decay time. Time between max time to the sustain level.	Level of audio sustained while note is still on.
Release		
Time: 0.00-10 Sec		
Amp envelope release time. Time from note off to silent.		

Envelope Filter - Page 2

Attack	Decay	Sustain
Time: 0.00-10 Sec	Time: 0.00-10 Sec	Level: 0.00-100%
Filter envelope attack time. Time for audio to reach max level.	Filter envelope decay time. Time between max time to the sustain level.	Level of audio sustained while note is still on.
Release		
Time: 0.00-10 Sec		
Filter envelope release time. Time from note off to silent.		



Envelope Aux - Page 3

Attack	Decay	Sustain
Time: 0.00-10 Sec	Time: 0.00-10 Sec	Level: 0.00-100%
Filter envelope attack time. Time for audio to reach max level.	Filter envelope decay time. Time between max time to the sustain level.	Level of audio sustained while note is still on.
Release		
Time: 0.00-10 Sec		
Filter envelope release time. Time from note off to silent.		

LFO 1 - Page 1

Sync	Frequency or Ratio	Waveform
On or Off	0-100 Hz or Intervals	Options
Set to Off for speed in frequency. On synchronises based on ratio of note interval divisions.	Speed of LFO in Hz or if Sync is on, in note interval ratios.	Modulation wave shape: Triangle, Sin, Ramp Up, Ramp Down, Square, Random S&H
Retrigger		
Options		
Waveform retrigger: Free running will continuously run; One Shot will cycle once when a note is triggered; Note will trigger from the start and continuously run each time a note is triggered.		

LFO 2 - Page 2

Sync	Frequency or Ratio	Waveform
On or Off	0-100 Hz or Intervals	Options
Set to Off for speed in frequency. On synchronises based on ratio of note interval divisions.	Speed of LFO in Hz or if Sync is on, in note interval ratios.	Modulation wave shape: Triangle, Sin, Ramp Up, Ramp Down, Square, Random S&H
Retrigger		
Options		
Waveform retrigger: Free running will continuously run; One Shot will cycle once when a note is triggered; Note will trigger from the start and continuously run each time a note is triggered.		

The auxiliary envelope and the two LFO's are not pre-patched into the WTFM engine by default. They can be patched in the mod page.

5.10 PMD Synth Voice

PMD™ PMD is a physical modelling synth that recreates, through synthesis, real-world instrument sounds and dynamics. The core concept covers two parts. The exciter is how or with what an instrument is played, e.g., a stick or pluck. The resonator represents instrument components, e.g., strings and percussion pads. These two functions are addressed with parameters in the engine and filter pages, respectively, as opposed to the typical oscillator and filter functions. The exciter envelope is also unique to this model and dependent on the generator configuration.

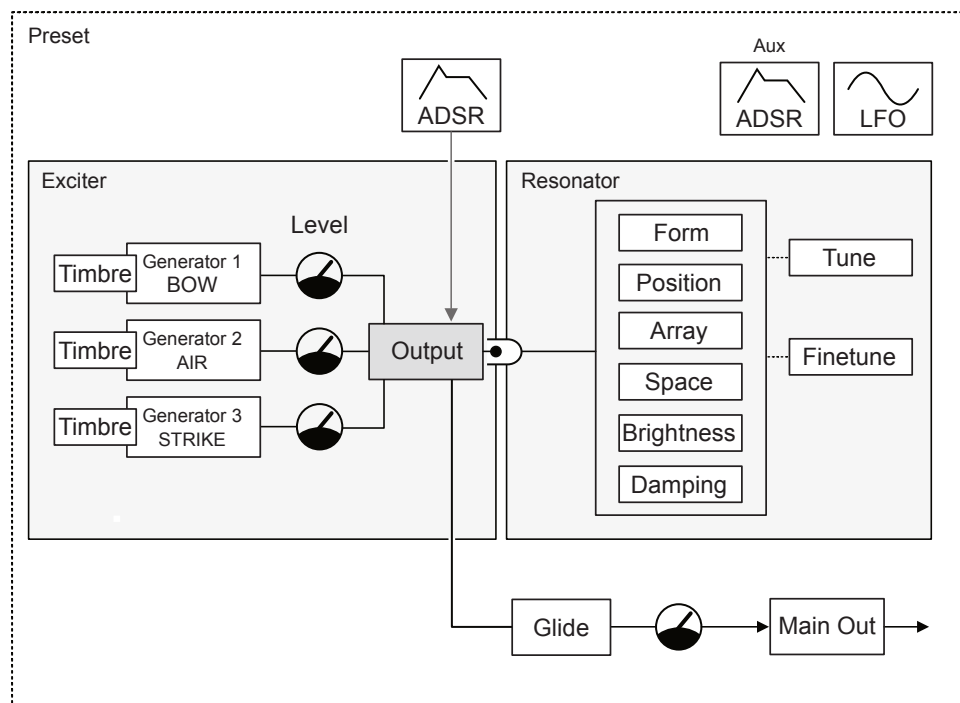

Exciter - Engine Oscillator Page 1

Bow Level	Air Level	Strike Level
0-150%	0-150%	0-150%
First generator engine representing bow like sound.	Second generator based on the physically modelled 'air'	Strike emulation physically modelled.
Timbre	Timbre	Timbre
0-100%	0-100%	0-100%
Timbre applied for the Bow	Timbre applied for the Air	Timbre applied for the Strike
	Air Flow	Mallet
	0-100%	0-100%
	Control over the character of the air flow feature	Control over the character of the mallet strike Behavior



Exciter - Engine Oscillator Page 2

Glide Mode	Glide Time	Volume
Options	0.00 - 3 Secs	0-200%
Slide between notes: Always, Overlap, Legato i.e. Envelopes are not triggered, Legato Overlap	Time of slide between notes.	Volume level of oscillator voice

Resonator - Filter Page 1

Form	Position	Space
0-100%	0-100%	0-100%
Resonator shapes the sound mix	Resonator shapes the sound mix	Resonator spacial effect picking different Left / Right positions.
Brightness	Damping	Array
0-100%	0-100%	0-100%
Resonator shapes the sound mix. Similar to low pass filtering.	Resonator shapes the sound mix. Similar to low pass filtering.	Resonator shapes the sound mix. Similar to low pass filtering.
Tune	Finetune	
-36 to +36 st	-100 to +100 c	
Tuning in semitones	Fine tuning in cents	

Envelope Exciter - Page 1

Attack	Decay	Sustain
Time: 0.00 - 8 Sec	Time: 0.00 - 8 Sec	Level: 0.00-100%
Exciter envelope attack time. Time for audio to reach max level.	Exciter envelope decay time. Time between max time to the sustain level.	Level of audio sustained while note is still on.
Release		
Time: 0.00 - 8 Sec		
Exciter envelope release time. Time from note off to silent.		



Envelope Aux - Page 2

Attack	Decay	Sustain
Time: 0.00-10 Sec	Time: 0.00-10 Sec	Level: 0.00-100%
Aux envelope attack time. Time for audio to reach max level.	Aux envelope decay time. Time between max time to the sustain level.	Level of audio sustained while note is still on.
Release		
Time: 0.00-10 Sec		
Aux envelope release time. Time from note off to silent.		

LFO 1 - Page 1

Sync	Frequency or Ratio	Waveform
On or Off	0-100 Hz or Intervals	Options
Set to Off for speed in frequency. On synchronises based on ratio of note interval divisions.	Speed of LFO in Hz or if Sync is on, in note interval ratios.	Modulation wave shape: Triangle, Sin, Ramp Up, Ramp Down, Square, Random S&H
Retrigger		
Options		
Waveform retrigger: Free running will continuously run; One Shot will cycle once when a note is triggered; Note will trigger from the start and continuously run each time a note is triggered.		

5 Synths

5.11 PHZ Synth Voice

NOTES

PHZ™ PHZ is a 2 oscillator, advanced phase distortion synth, ideal for experimental and explorative sounds. At the heart of PHZ is a creative X-Y modulation matrix function adding movement to sound designs as well as a filter inspired by classic synth filter models.

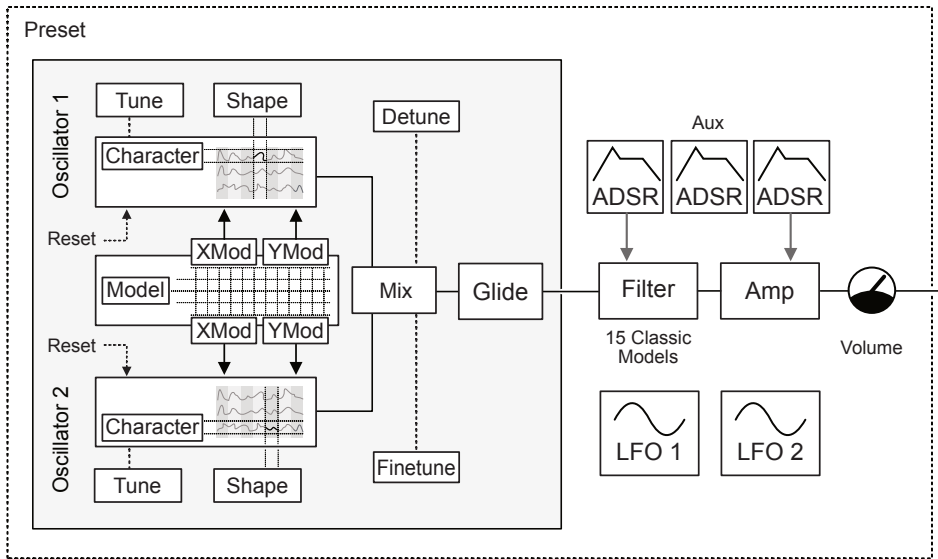

Engine Oscillator - Page 1

Shape 1	Shape 2	Mix
0 to 100	0 to 100	0-100%
Oscillator 1 shape. Morphs horizontally across the wavetable wave row.	Oscillator 2 shape. Morphs horizontally across the wavetable wave row.	Mix of the audio from the two oscillators.
Osc1 XMod	Osc2 XMod	
0-1	0-1	
Oscillator 1 X modulation. Function depends on the modulation model selected.	Oscillator 2 X modulation. Function depends on the modulation model selected.	
Osc1 YMod	Osc2 YMod	Model
0-1	0-1	Options
Oscillator Y modulation. Function depends on the modulation model selected.	Oscillator Y modulation. Function depends on the modulation model selected.	Modulation model: OG Saw, OG Square, Hermite Smooth, Squared, Linear, Hermite FM



Engine Oscillator - Page 2

Reset 1	Reset 2	Detune
On - Off	On - Off	0-100 Cents
Oscillator 1 wave reset with note on.	Oscillator 1 wave reset with note on.	Oscillator mix detuning in cents
Tune 1	Tune 2	Finetune
-36 to + 36 st	-36 to + 36 st	-100 to +100 Cents
Oscillator 1 Tuning in semitones	Oscillator 2 Tuning in semitones	Finetuning of the audio mix in cents
Character 1	Character 2	
Options	Options	
Selects wavetable row. Refers to type of shape. Smoother, Sharper, Wilder, Add 1, Add 2, Add 3, Add 5, Add 7, Add 11.	Selects wavetable row. Refers to type of shape. Smoother, Sharper, Wilder, Add 1, Add 2, Add 3, Add 5, Add 7, Add 11.	

Engine Oscillator - Page 3

Glide Mode	Glide Time	Volume
Options	0.00 - 3 Secs	0-200%
Slide between notes: Always, Overlap, Legato i.e. Envelopes are not triggered, Legato Overlap	Time of slide between notes.	Volume level of oscillator voice

Filter - Page 1

Cutoff	Resonance	Type
Frequency: 20Hz - 20kHz	Amount: 0-100%	Filter Model
Frequency point at which the audio is attenuated.	Emphasises the frequencies at the cutoff position.	Low Pass MG 24dB, Low Pass OB 24dB, Low Pass OB 12dB, Low Pass SVF 24dB, Low Pass SVF 12dB, Hi Pass OB 24dB, Hi Pass OB 12dB, Hi Pass SVF 24dB, Hi Pass SVF 12dB, Band Pass OB 24dB, Band Pass OB 12dB, Band Pass SVF 24dB, Band Pass SVF 12dB, Notch SVF 24dB, Notch SVF 12dB,
Envelope Amount		Note Track
Amount: -100% to +100%		Amount: -200% to +200%
Amount of envelope applied to the filter.		Amount of modulation applied based on the pitch of the note played.



Envelope Amp - Page 1

Attack	Decay	Sustain
Time: 0.00-10 Sec	Time: 0.00-10 Sec	Level: 0.00-100%
Amp envelope attack time. Time for audio to reach max level.	Amp envelope decay time. Time between max time to the sustain level.	Level of audio sustained while note is still on.
Release		
Time: 0.00-10 Sec		
Amp envelope release time. Time from note off to silent.		

Envelope Filter - Page 2

Attack	Decay	Sustain
Time: 0.00-10 Sec	Time: 0.00-10 Sec	Level: 0.00-100%
Filter envelope attack time. Time for audio to reach max level.	Filter envelope decay time. Time between max time to the sustain level.	Level of audio sustained while note is still on.
Release		
Time: 0.00-10 Sec		
Filter envelope release time. Time from note off to silent.		

Envelope Aux - Page 3

Attack	Decay	Sustain
Time: 0.00-10 Sec	Time: 0.00-10 Sec	Level: 0.00-100%
Aux envelope attack time. Time for audio to reach max level.	Aux envelope decay time. Time between max time to the sustain level.	Level of audio sustained while note is still on.
Release		
Time: 0.00-10 Sec		
Aux envelope release time. Time from note off to silent.		



LFO 1 - Page 1

Sync	Frequency	Waveform
Options	0-100 Hz	Options
When set to On, Oscillator 2 resets on each cycle of Oscillator 1 (Osc 1 controls pitch).	Speed of LFO	Modulation wave shape: Triangle, Sin, Ramp Up, Ramp Down, Square, Random S&H
Retrigger		
Options		
Waveform retrigger: Free running will continuously run; One Shot will cycle once when a note is triggered; Note will trigger from the start and continuously run each time a note is triggered.		

LFO 2 - Page 2

Sync	Frequency or Ratio	Waveform
On or Off	0-100 Hz or Intervals	Options
Set to Off for speed in frequency. On synchronises based on ratio of note interval divisions.	Speed of LFO in Hz or if Sync is on, in note interval ratios.	Modulation wave shape: Triangle, Sin, Ramp Up, Ramp Down, Square, Random S&H
Retrigger		
Options		
Waveform retrigger: Free running will continuously run; One Shot will cycle once when a note is triggered; Note will trigger from the start and continuously run each time a note is triggered.		

The Auxiliary Envelope and the two LFO's are not pre-patched into the PHZ engine by default. They can be patched in the Mod page.

Additional Notes for PHZ Synth Engine.

Models

The oscillators are modulated by a selectable model each of which operates by generating an X-Y output. The available model functions include:-

1. OG Saw.
A recreation of a saw distortion function of a CZ series.
 - X gradually goes from sine (0.0) to saw (1.0),
 - Y tends to warp the waveform towards left (0.0) or right (1.0).
 - With Y set to 0.5 generates a pure sine to saw
2. OG Square.
Same as the OG saw but "square" instead of "saw"
3. Hermite Smooth.
The warmest variation of a linear phase distortion.
4. Squared.
A variation of the linear function but with the usage of 2 square functions. Produces a little bit warmer sounds
5. Linear.
A linear phase distortion function that distorts the sine to saw-like territory. X , Y are the coordinates of a point in which the phase distortion function collapses.
6. Hermite FM
A variation of a PD that goes to an FM territory. X is squishing the waveform towards left or right (like in the linear variations) but Y is increasing the parameter which folds the phase distortion function. Makes phase to wrap, sounding like FM.

In many cases the modulation is symmetrical in results. So for example in the linear variations the output of $x = 0.0, y = 1.0$ sounds almost the same as $x = 1.0, y = 0.0$.

5.12 GRAIN Synth Voice

GRAIN™ GRAIN is a granular synthesizer which scans the audio file and generates small grains of audio which can be manipulated and tuned in the engine. Great for creating rich textures and ambient backdrop pads and sounds. The 16-bit mono, 44.1 kHz WAV files are tuned to 'C' and are stored on the microSD Card in the folder Samples/GRAIN.

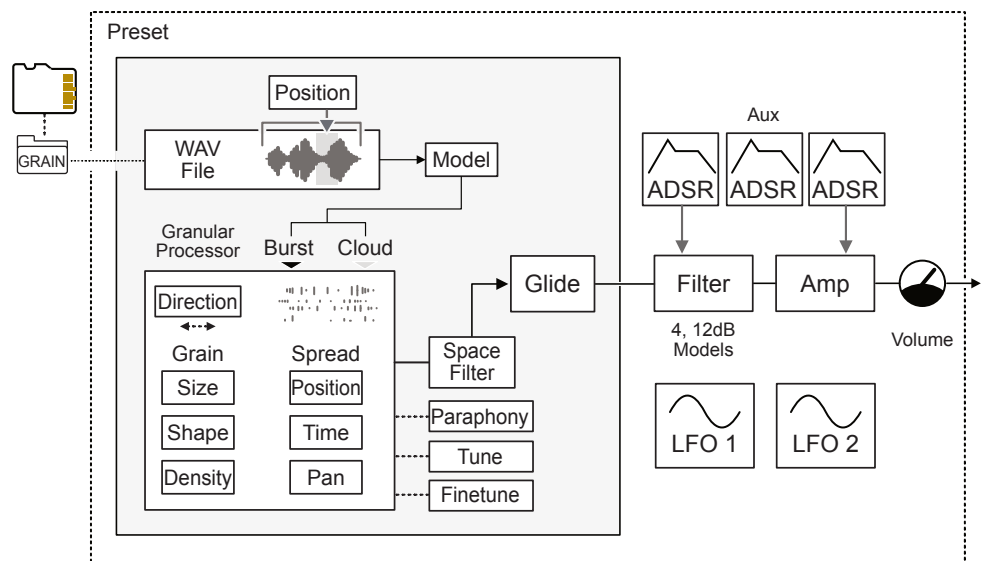

Engine Oscillator Page 1

Wav File	Position	Position Spread
Source Sample File	0-100%	0-100%
WAV Audio sample tuned to C. Located on the microSD in the Samples/Grain folder	Scanning position of the original WAV sample.	Varies and spreads the scanning position.
Grain Size	Density	Time Spread
0.01s to 1s	0-100%	0-100%
Size / Length of the generated grains	Amount of grains generated. Max 128 simultaneous grains.	Randomises the timing of generating grains.
Grain Shape	Model	Pan Spread
-100 to +100	Cloud or Burst	0-100%
Envelope shape for the grain volume. 0 is smooth. +100 Square / -100 Saw style env	Cloud generates grains continuously. Burst generates grains in batches.	Varies and spreads the position in the stereo plane.



Engine Oscillator - Page 2

Tune	Burst Sync	Detune Spread
-12 to + 12 Semitones	On - Off	0-100%
Tuning of the oscillator pitch.	Controls whether the burst cycles are synchronised.	Variation of the detuning.
Finetune	Burst Freq	Size Spread
-100 to +100 Cents	Hz or Note Intervals	0-100%
Finetuning of the oscillator pitch.	Sets burst cycle frequency based on the sync state on (note interval) or off (Hz)	Variation spread of the grain size
Direction	Burst Retrigger	Space
-100 to +100	Options	0-100%
Playback direction of grains. Reverse -, Forward + and 0 is forward and reverse.	Free running will run continuously, One Shot cycles once on a note trigger, Note will trigger and continuously run from the start	End of audio chain spatial effect, smoothing grains using a diffusion filter.

Engine Oscillator - Page 3

Glide Mode	Glide Time	Volume
Options	0.00 - 3 Secs	0-200%
Slide between notes: Always, Overlap, Legato i.e. Envelopes are not triggered, Legato Overlap	Time of slide between notes.	Volume level of oscillator voice
Paraphony		
On or Off		
On: Grains will cover all notes played. This enables only 1 voice to play chords.		

The voicing when using a GAIN engine can be optimised by using paraphonic mode. This will allow chords to be played when only 1 voice is allocated to the synth.

GRAIN™

Filter - Page 1

Cutoff	Resonance	Type
Frequency: 20Hz - 20kHz	Amount: 0-100%	Filter Model
Frequency point at which the audio is attenuated.	Emphasises the frequencies at the cutoff position.	Low Pass SVF 12dB, Hi Pass SVF 12dB, Band Pass SVF 12dB, Notch SVF 12dB
Envelope Amount		Note Track
Amount: -100% to +100%		Amount: -200% to +200%
Amount of envelope applied to the filter.		Amount of modulation applied based on the pitch of the note played.

Envelope Amp - Page 1

Attack	Decay	Sustain
Time: 0.00-10 Sec	Time: 0.00-10 Sec	Level: 0.00-100%
Amp envelope attack time. Time for audio to reach max level.	Amp envelope decay time. Time between max time to the sustain level.	Level of audio sustained while note is still on.
Release		
Time: 0.00-10 Sec		
Amp envelope release time. Time from note off to silent.		

Envelope Filter - Page 2

Attack	Decay	Sustain
Time: 0.00-10 Sec	Time: 0.00-10 Sec	Level: 0.00-100%
Filter envelope attack time. Time for audio to reach max level.	Filter envelope decay time. Time between max time to the sustain level.	Level of audio sustained while note is still on.
Release		
Time: 0.00-10 Sec		
Filter envelope release time. Time from note off to silent.		



Envelope Aux - Page 3

Attack	Decay	Sustain
Time: 0.00-10 Sec	Time: 0.00-10 Sec	Level: 0.00-100%
Aux envelope attack time. Time for audio to reach max level.	Aux envelope decay time. Time between max time to the sustain level.	Level of audio sustained while note is still on.
Release		
Time: 0.00-10 Sec		
Aux envelope release time. Time from note off to silent.		

LFO 1 - Page 1

Sync	Frequency or Ratio	Waveform
On or Off	0-100 Hz or Intervals	Options
Set to Off for speed in frequency. On synchronises based on ratio of note interval divisions.	Speed of LFO in Hz or if Sync is on, in note interval ratios.	Modulation wave shape: Triangle, Sin, Ramp Up, Ramp Down, Square, Random S&H
Retrigger		
Options		
Waveform retrigger: Free running will continuously run; One Shot will cycle once when a note is triggered; Note will trigger from the start and continuously run each time a note is triggered.		

LFO 2 - Page 2

Sync	Frequency or Ratio	Waveform
On or Off	0-100 Hz or Intervals	Options
Set to Off for speed in frequency. On synchronises based on ratio of note interval divisions.	Speed of LFO in Hz or if Sync is on, in note interval ratios.	Modulation wave shape: Triangle, Sin, Ramp Up, Ramp Down, Square, Random S&H
Retrigger		
Options		
Waveform retrigger: Free running will continuously run; One Shot will cycle once when a note is triggered; Note will trigger from the start and continuously run each time a note is triggered.		

5.13 DWA Synth

DWA™ DWA is a dual wavetable synthesizer which uses two samples that can be cross-mixed, looped and manipulated in various ways. DWA can be played back polyphonically and all engine parameters can be assigned to macros or aftertouch. Manipulate multiple parameters on a patch at once for instant transformations.

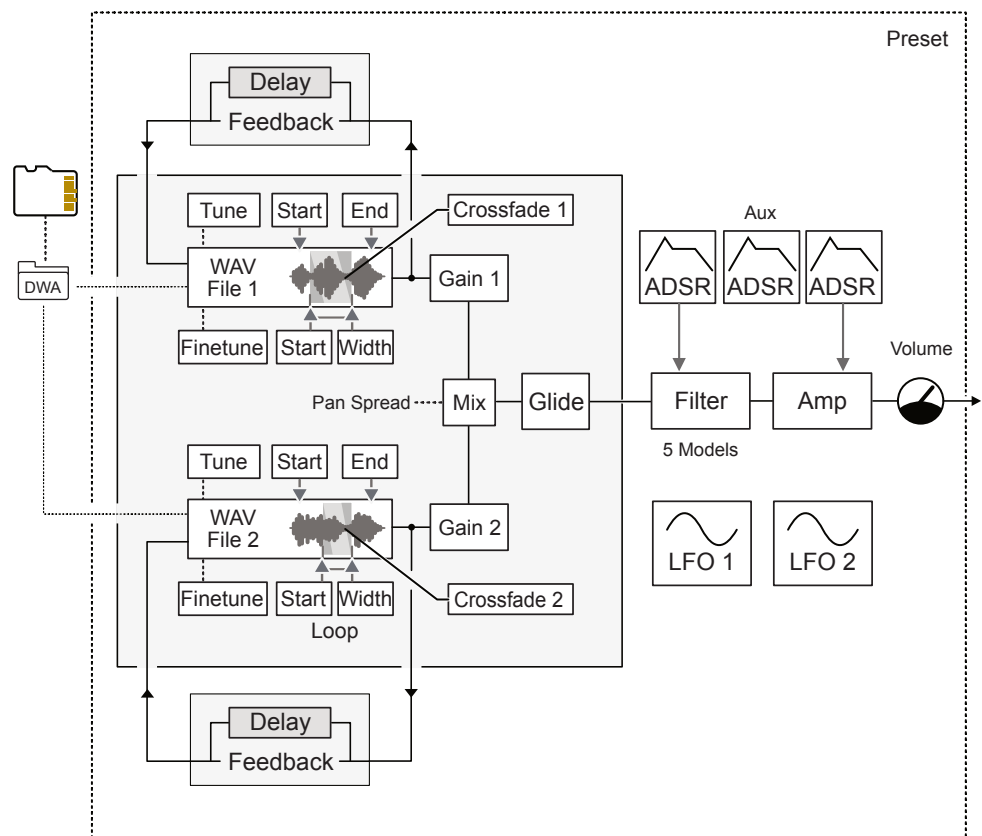

About sample tuning.

All sample files are assumed to be in the root of C4 and can be tuned when loaded. Feedback and single cycle waveforms generally tune themselves based on the note played. If the sample's base pitch is different than the default C4 the tuning could be off. To prevent this, Synths DWA engine autotunes most samples if the filename ends in underscore + root note including sharps. For example Pad_Ice_C#4.wav would be retuned.

Note that C4 tuning affects the single cycle and feedback tuning when Note Tracking is On. For example, when loading a sample with a root frequency of F#, tuning of the single cycle and/or feedback will not match and cannot be fixed by tune or finetune params.

For optimum performance it is recommended to prepare and tune samples in advance before installing to Synth.



Engine Oscillator 1 Page 1

Wav File	Start	End
Source Sample 1 File	0-100%	0-100%
WAV Audio sample tuned to C4. Located on the microSD in the Samples/DWA folder.	Start position of the original WAV sample.	End position of the original WAV sample.
Tune	Loop Start	Loop Width
-36 to + 36 st	0-100%	0-100%
Tuning of sample in semitones.	Start point of the sample loop range.	Width of the loop. This sets the end position with respect to the loop start.
Finetune	Play Mode	Direction
-100 to +100 cents	Options	Forward or Backwards
Tuning of sample in cents.	One-shot - plays once and stops. Loop - plays loop range repeatedly. Sync loop - plays loop synchronised to global tempo. Ping-pong - plays start to end to start etc.	Initial playback direction.

Engine Oscillator 2 Page 2

Wav File	Start	End
Source Sample 2 File	0-100%	0-100%
WAV Audio sample tuned to C4. Located on the microSD in the Samples/DWA folder.	Start position of the original WAV sample.	End position of the original WAV sample.
Tune	Loop Start	Loop Width
-36 to + 36 st	0-100%	0-100%
Tuning of sample in semitones.	Start point of the sample loop range.	Width of the loop. This sets the end position with respect to the loop start.
Finetune	Play Mode	Direction
-100 to +100 cents	Options	Forward or Backwards
Tuning of sample in cents.	One-shot - plays once and stops. Loop - plays loop range repeatedly. Sync loop - plays loop synchronised to global tempo. Ping-pong - plays start to end to start etc.	Initial playback direction.



Engine Oscillator Page 3

Glide Mode	Glide Time	Volume
Options	0.00 - 3 Secs	0-200%
Slide between notes: Always, Overlap, Legato i.e. Envelopes are not triggered, Legato Overlap	Time of slide between notes.	Volume level of the entire voice
Gain 1	Gain 2	Mix
Gain for Osc 1	Gain for Osc 2	-100% to +100%
Oscillator 1 output gain, irrespective of mix.	Oscillator 2 output gain, irrespective of mix.	Mix between oscillator 1 and oscillator 2.
Crossfade 1	Crossfade 2	Pan Spread
0 -100	0-100	0-100
Crossfade between playhead transitions while the sample loops.	Crossfade between playhead transitions while the sample loops.	Stereo width of the two oscillators.

Filter - Page 1

Cutoff	Resonance	Type
Frequency: 20Hz - 20kHz	Amount: 0-100%	Filter Model
Frequency point at which the audio is attenuated.	Emphasises the frequencies at the cutoff position.	Low Pass MG24, Low Pass SV12, Hi Pass SV12, Band Pass SV12, Notch SV12
Envelope Amount	Note Track	
Amount: -100% to +100%	Amount: -200% to +200%	
Amount of envelope applied to the filter.	Amount of modulation applied based on the pitch of the note played.	

Feedback | Filter - Page 2

Feedback 1	Feedback 2	
0-200	0-200	
Amount of feedback from the output to the input. Includes volume compensation.	Amount of feedback from the output to the input. Includes volume compensation.	
Delay Time 1	Delay Time 2	
-1.000 to + 1.000 / 0-46ms	-1.000 to + 1.000 / 0-46ms	
Pitch tracking On: Delay time relative to oscillator pitch. Pitch tracking Off: Absolute in milliseconds.	Pitch tracking On: Delay time relative to oscillator pitch. Pitch tracking Off: Absolute in milliseconds.	
Pitch Track 1	Pitch Track 2	
On / Off	On / Off	
Sets feedback delay mode.	Sets feedback delay mode	



Envelope Amp - Page 1

Attack	Decay	Sustain
Time: 0.00-10 Sec	Time: 0.00-10 Sec	Level: 0.00-100%
Amp envelope attack time. Time for audio to reach max level.	Amp envelope decay time. Time between max time to the sustain level.	Level of audio sustained while note is still on.
Release		
Time: 0.00-10 Sec		
Amp envelope release time. Time from note off to silent.		

Envelope Filter - Page 2

Attack	Decay	Sustain
Time: 0.00-10 Sec	Time: 0.00-10 Sec	Level: 0.00-100%
Filter envelope attack time. Time for audio to reach max level.	Filter envelope decay time. Time between max time to the sustain level.	Level of audio sustained while note is still on.
Release		
Time: 0.00-10 Sec		
Filter envelope release time. Time from note off to silent.		

Envelope Aux - Page 3

Attack	Decay	Sustain
Time: 0.00-10 Sec	Time: 0.00-10 Sec	Level: 0.00-100%
Aux envelope attack time. Time for audio to reach max level.	Aux envelope decay time. Time between max time to the sustain level.	Level of audio sustained while note is still on.
Release		
Time: 0.00-10 Sec		
Aux envelope release time. Time from note off to silent.		



LFO 1 - Page 1

Sync	Frequency	Waveform
Options	0-100 Hz	Options
When set to On, Oscillator 2 resets on each cycle of Oscillator 1 (Osc 1 controls pitch).	Speed of LFO	Modulation wave shape: Triangle, Sin, Ramp Up, Ramp Down, Square, Random S&H
Retrigger		
Options		
Waveform retrigger: Free running will continuously run; One Shot will cycle once when a note is triggered; Note will trigger from the start and continuously run each time a note is triggered.		

LFO 2 - Page 2

Sync	Frequency or Ratio	Waveform
On or Off	0-100 Hz or Intervals	Options
Set to Off for speed in frequency. On synchronises based on ratio of note interval divisions.	Speed of LFO in Hz or if Sync is on, in note interval ratios.	Modulation wave shape: Triangle, Sin, Ramp Up, Ramp Down, Square, Random S&H
Retrigger		
Options		
Waveform retrigger: Free running will continuously run; One Shot will cycle once when a note is triggered; Note will trigger from the start and continuously run each time a note is triggered.		

The Auxiliary Envelope and the two LFO's are not pre-patched into the DWA engine by default. They can be patched in the Mod page.

5 Synths

5.14 DIRT Synth

NOTES

DIRT™ Dirt is a waveshaping and warping synth with 13 shaper modes, flexible pre/post-filter routing and gain-staging, and modulatable warp and shape amounts. Designed to create thick bass without losing sub-rumble, drive leads, smear pads, or give lo-fi chords a crackle. Warp the core oscillator before it hits the shaper to move from a warm push to full-on destruction in just a few controls.

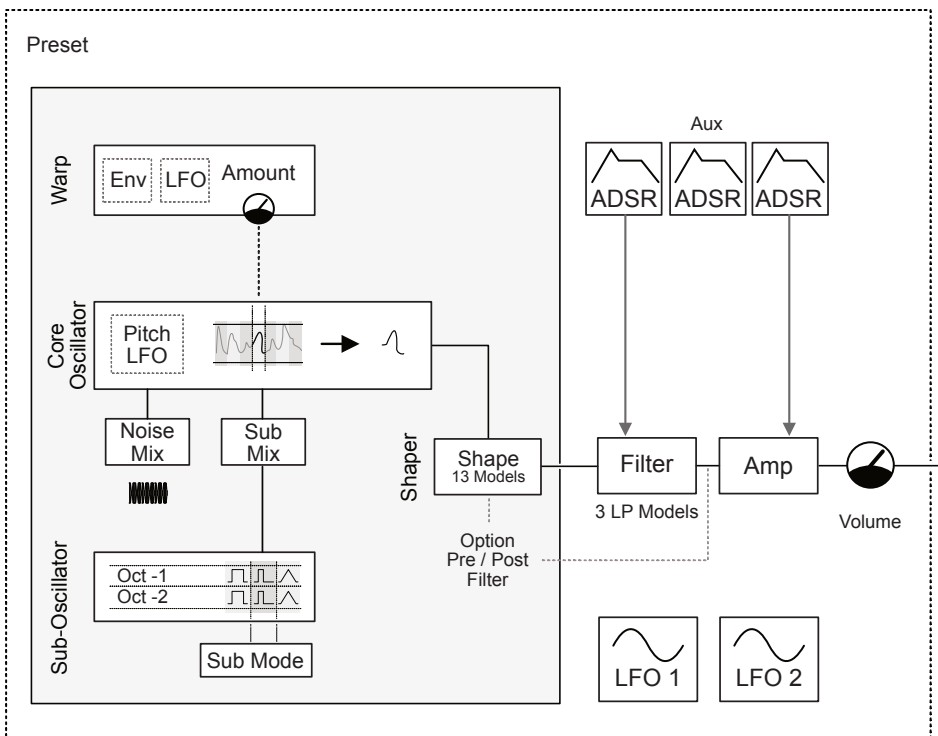

Function	Parameter	Range	Description
Oscillator	Shape	0% to 100%	Main oscillator shape.
Oscillator	Warp	-100% to 100%	Warp amount.
Oscillator	Sub Mix	0-100%	Amount of sub osc applied to the mix.
Oscillator	Noise Mix	-100% to 100%	Amount of noise introduced in dirt.
Oscillator	Sub Mode	Options	Sub oscillator shape from square, pulse and triangle set and set to -1 or -2 Octave lower.
Oscillator	Pitch LFO	-100% to 100%	Amount of LFO applied to the osc pitch.
Oscillator	Warp Env	-100% to 100%	Amount of envelope applied to warp.
Oscillator	Warp LFO	-100% to 100%	Amount of LFO applied to warp.



Function	Parameter	Range	Description
Shaper	Shaper	Options	None or...
			Saturation, subtle harmonic distortion.
			Overdrive, subtle harmonic distortion.
			Diode, symmetrical diode clipping.
			Fuzz, classic fuzz tone.
			Asymmetric, diode clipping.
			Sin, a sine wave to shape the signal.
			Sin+, warped waveform shapes the signal.
			Rectifier, Converts a bipolar signal to unipolar for clipped drive tones. Adds the possibility of octave up effects.
			Bitcrush, Reduces the number of bits in the audio signal. Bitcrush+.
Redux, Sample Rate Reduction. Redux+, Bitcrush+Redux.			
Shaper	Amount	0-100%	Amount of shaper applied.
Shaper	Mod Env	-100% to 100%	Amount of modulation envelope applied.
Shaper	Routing	Options	Pre or Post filter positioning of the shaper
Shaper	Pre Gain	0-100	Input gain adjustment.
Filter	Cutoff	20Hz - 20kHz	Filter cutoff frequency. Set the frequency or set filter to off.
Filter	Resonance	0-150%	Resonance amount.
Filter	Type	Options	Low Pass SVF 12dB, Low Pass SVF 24dB, Low Pass RD3.
Filter	Env Amt	-100% to 100%	Filter envelope amount
Filter	Note Track	-200% to 200%	Amount of modulation applied based on the pitch of the note played.
Filter	LFO Amt	-100% to 100%	Amount of LFO applied to the filter.
Amplifier	Attack	0-10 Sec	Amp envelope attack time.
Amplifier	Decay	0-10 Sec	Amp envelope decay time.
Amplifier	Sustain	0-100%	Amp envelope sustain level.
Amplifier	Release	0-10 Sec	Mod envelope release time.
Modulation	Attack	0-10 Sec	Mod envelope attack time.
Modulation	Decay	0-10 Sec	Mod envelope decay time.
Modulation	Sustain	0-100%	Mod envelope sustain level.
Modulation	Release	0-10 Sec	Mod envelope release time.
Modulation	Frequency	0.1Hz to 100Hz	Modulation LFO speed.
Modulation	Waveform	Options	LFO Shape: Triangle, Sin, Ramp Up, Ramp Down, Square, Random Sample and Hold.
Modulation	Retrigger	Options	LFO retrigger options: Note, One Shot, Free Running
Voice	Glide Mode	Options	Slide between notes: Always, Overlap, Legato i.e. Envelopes are not triggered, Legato Overlap
Voice	Glide Time	0.00 - 3 Sec	Time of slide between notes.
Voice	Volume	0-200%	Volume level of oscillator voice.

5 Synths

5.15 MIDI Instrument

NOTES

midi The MIDI Instrument is also available in the synth engine presets. The MIDI Instrument allows CC configurations to be created, saved, and loaded, building a library of MIDI control change presets. MIDI Instrument has 4 Pages of CC parameters and also macros can be used to map up to 5 CCs.

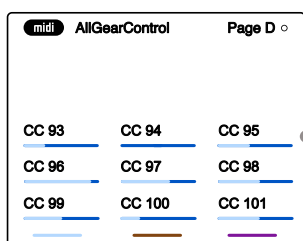

MIDI Instrument Preset

The 9 CC Controls are represented by the 9 rotary knobs.

Turn (Screen) to select the pages and mappings A-D.

When selecting the MIDI instrument and choosing 'Init', the mapping page is displayed. Map A-D allows configuration of the CC numbers to assign to each knob. The Map A-D pages correspond to Page A-D where the actual CC control is performed, and is the normal operating environment.

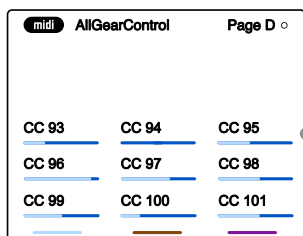

MIDI Instrument Mapping

The CC numbers can be assigned for each knob. The controls are then accessible from the MIDI Instrument page.

5.16 Macros

Macros allow a collection of selected parameters to be assigned to a single control knob. This knob is then used to adjust all these parameters together. The three C1, C2, and C3 knobs are used for macro control. Velocity (default volume) and pressure macros also exist.

Using synth macro & combo controls

The macros are controlled using the C1, C2, and C3 knobs. This will adjust the values of the parameters assigned. An example is to control both the filter and amp envelope attack with one knob. When changing the macro knob, the parameters of the currently selected synth are edited.

In addition the C1, C2 and C3 knobs can be used to control a macro combination of all common parameters for multiple synths. This is performed by holding multiple synth screen buttons while adjusting the macro knob.

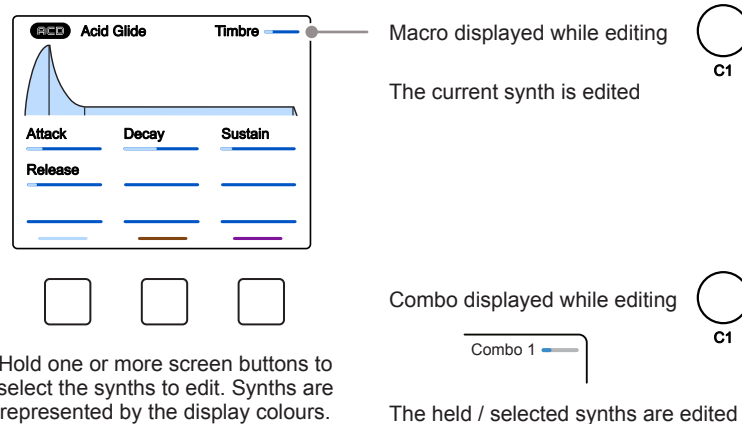



ADJUSTING A MACRO

1. Select a Synth using the screen buttons.
2. Adjust the macro. Turn (C1) or (C2) or (C3). The selected macro will be adjusted and in turn affect the parameters assigned to the macro. The macro and value is displayed top right.
3. Adjust macros for several Synths. Hold the screen buttons for each of the 3 synths to edit + turn (C1) or (C2) or (C3). The selected macro will be adjusted for all selected synths. The 'Combo' name and value is displayed top right.

Creating and editing macros

Macro configuration is performed in the main menu. Up to 5 Parameters can be assigned to each of the 'C' knobs. Velocity and Aftertouch/Pressure can also be setup using the same method.

- 
1. Timbre
Macro Name
- 
2. Movement
Macro Name
- 
3. Experiment
Macro Name

Macros are edited in the Main Menu under the 'Macro' Option

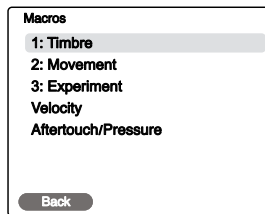

The names shown are typical macro convention names

CONFIGURING A MACRO

- Select the macro menu. Press the (Screen) knob to open the main menu. Turn (Screen) to scroll and navigate the menu to highlight the 'Macros' option. Press (Screen) to select 'Macros' sub-menu.
- Select a macro to edit. Turn (Screen) knob to highlight one of the 3, 'C' knob macros or select 'Velocity' or 'Pressure'. Press (Screen) knob to select the macro.
- The 5 parameter slots per macro can be assigned to a parameter in the synth voice. For example synth engine or filter parameters etc. It is also possible to edit the macro name or change the bipolar behavior here

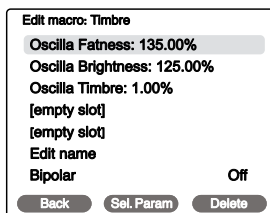

Parameters assigned to the macro

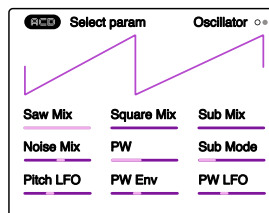

Parameter assignment page

NOTES

4. Select a parameter. Turn (Screen) to highlight a parameter slot and then press [*Sel. Param*] screen button to select. The assignment page opens to reveal the parameter to assign. Note this is a similar style as the synth functions so do not confuse with a standard pages.
5. Select through the engine, filter, ADSR or LFO pages to choose the page with the parameter to assign. Example, press [Engine] to locate the parameter to assign to the macro.
6. Select the parameter. Tap the knob for the parameter to assign. This is one of the 9 touch sensitive knobs which represents the 9 parameters on display. Example: Tap 'Sub Mix' on the ACD Engine page.
7. The display will revert back automatically to the macro editor page.
8. The parameter range can be adjusted by turning the parameter knob while the parameter is highlighted in the macro page. Example, adjust a knob to set the 'Sub-Mix' between -200% and +200%. Note that this refers to the range of control for the parameter assigned to the macro and is not the setting for the parameter itself.
9. To delete a parameter, highlight the parameter row in the macro page and press [*Delete*] screen button.

Macro Range

Example: Macro mapping for 'Motion'



			Macro
Macro Name	'Motion'	<i>Name can be edited - 'Edit Name' option</i>	
Bipolar	Off	<i>Knob range</i>	
Parameter 1	LFO Frequency	Value	20.00%
Parameter 2	Filter LFO	Value	30.00%
Parameter 3		Value	
Parameter 4		Value	
Parameter 5		Value	
etc		<i>e.g. 200% would double the sound</i>	

5.17 Filter

Most synth voices operate with a filter section. A variety of filter models and applications exist. Polyend Synth is inspired by many classic filters as well as standard filter models. Synth has a filter section with models defined for each engine and accessible using the dedicated [Filter] button.

Filter concepts

A filter typically operates over a 20Hz to 20kHz range, which matches the range of human hearing. A filter carves out frequencies in order to shape the sounds character and timbre. Used as a standard in subtractive synthesis but increasingly used in other synth models.

2 Slope
Affects how aggressive or moderate the attenuation.
Example: 24dB / Octave.

4 Resonance
Frequency is emphasised at the cutoff point.

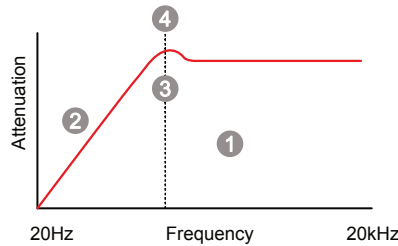

1 Filter Model
Designs perform various functions. Example: Low Cut.

3 Cutoff Frequency
Point at which frequencies are attenuated.

Filter Models

Low Cut / High Pass
Attenuates frequencies below the cutoff point.



Hi Cut / Low Pass
Attenuates frequencies above the cutoff point.

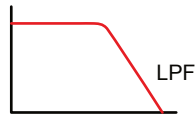

Bandpass
Attenuates frequencies above and below cutoff.

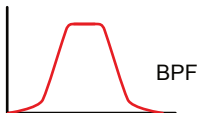

Notch
Attenuates frequencies within a narrow cutoff.



State Variable Filter (SVF)

A state variable filter can consist of an integration of models, typically HPF, LPF and BP which operate within a single model.

Filter Slopes

24dB / Octave
Aggressive slope to cut frequencies sharply.



12dB / Octave
Attenuates more frequencies, moderately.

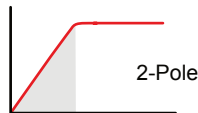

NOTES

Other than the PMD Synth model, the filter parameters follow a similar setup within each engine. The filter is also controlled by default using an ADSR envelope which shapes the filter behavior.

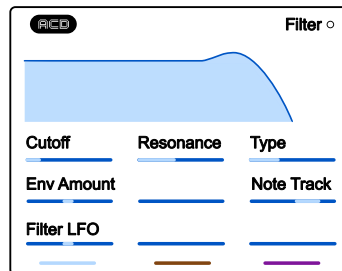

Parameter	Description
Cutoff	Cutoff frequency. The point in the frequency range where the attenuation begins. The amount of frequency attenuation is based on the cutoff frequency as well as the models slope.
Resonance	Resonance emphasises and boosts the small range of frequencies at the cutoff point. This introduces a unique shrill sound to the audio signal ideal for percussive sounds.
Type	A selection of synth models. These include low pass, high pass, band pass, notch or state variable, also with various slopes. These models are also inspired in their design from classic synth filters.
Env amount	The amount of ADSR - attack, decay, sustain and release envelope that is applied to shape the filter.
Note track	Sets note tracking on or off. Tracking links the application of the modulation envelope to the note pitch played over a keyboard range. The higher the note played the more the filter will open and therefore sound brighter.
Filter LFO	Adjusts the amount of the LFO applied to the filter cutoff. This is only available on certain models by default.

MG24 Filter model & modulation:

Due to the nature of the classic MG24 filter type it is not recommended to use a square wave source when modulating the filter to avoid audio artefacts.

5 Synths

5.18 Envelopes

NOTES

The general principle is that a set of envelopes are available in Synth which can be used for modulation patching but are also have some default patching in the synth engines for control of the filter and amp. The modulation details are covered elsewhere.

Envelope concepts

An envelope shapes the journey of the sound over its lifecycle, from an initial note on state and later to the note off behavior.

① **Attack**
Time from note on to the maximum level reached.

② **Decay**
The period, in time from maximum level to settling at the sustain level.

③ **Sustain**
Level maintained while note is on after decay period.

④ **Release**
Time from a note off to reduce the audio to 0.

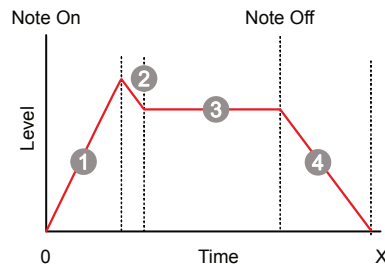

Synth envelopes

Various envelope types exist with Synth adopting the ADSR model, which controls the attack, decay, and release times and a sustain level. With an extended release and short decay time, you can hold a note that decays faster than if you tap it because then it enters the release phase. There are up to 3 envelopes per synth voice. A default preset model typically controls the filter cutoff from one ADSR envelope and the amp volume level from another ADSR envelope. An optional aux envelope in some presets is also freely patchable. All envelopes can be patched individually to add other destinations.

NOTES

The dedicated [ADSR] button is used to access the envelope options, each allocated to an ADSR page.

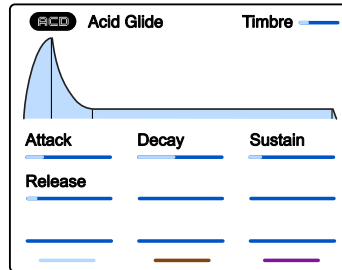

Parameter	Description
Attack	The time the sound takes from the note on to reach its maximum level. This is ranges 0.00 - 10 seconds in the synth envelopes. Typically short attacks are used for percussive sounds and longer duration to build sound gradually for example a pad.
Decay	The time the sound takes from its maximum level to settling at the sustain level. This covers the natural decay after an initial 'hit' or 'pluck' of an instrument. This is ranges 0.00 - 10 seconds in the synth envelopes.
Sustain	The level at which the sound is sustained while the note on state continues. This would remain high for sustained chords, pads or drones and may drop low for percussive sounds. 0-100%.
Release	The time the sound takes from its sustain level to reach zero once the note is lifted off. This represents the natural decay and fade out at the end of a note. This is ranges 0.00 - 10 seconds in the synth envelopes.

6

Effects & Modulation

Synth has three master effects: Mod, a delay style chorus/phaser/flanger effect; Del, a classic double delay; and Rev, a reverb offering classic room emulations or unique ambient styles. Each effect operates as a send/return model. An amount of audio is sent from each synth to the common effect, and the effect audio is returned back into the main mix. The effects are common to all synths, and the parameters can be controlled and set up for each. In addition, the option to route audio from the effects to other effects is also possible. The overall mix and panning of the synth audio is controlled along with the effect sends in the mixer section. A dedicated modulation matrix is also available, which allows the envelopes or

LFOs to be connected to specified destinations. Some synth engines, like ACD, have predefined modulation routing, while others have freely assignable modulation options. The synth engines will determine the envelope and LFO configurations and the availability of the parameters to modulate.

6 Effects & Modulation

6.1 Effect Structure

NOTES

The master effect section consists of a Mod, Delay, and Reverb effect and operates as a send/return arrangement. This means that a controllable amount of audio from each synth's primary signal path can be sent to the effects, and then the effect output is returned to the main mix. The sends are controlled in the mixer pages.

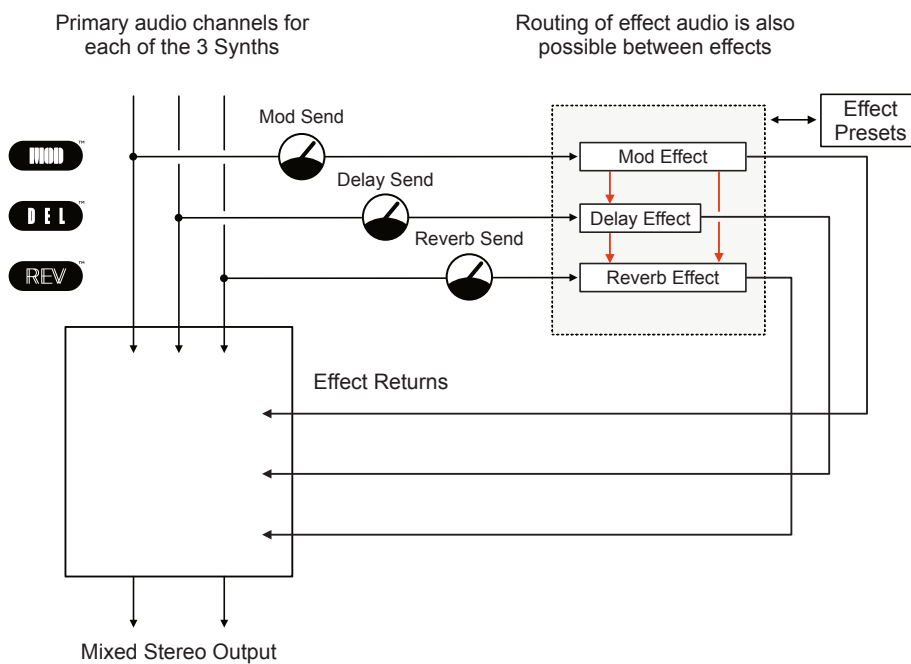

Effects are only active when they are used in a scene, otherwise by default they will be inactive in order to preserve CPU performance.

The parameter settings for each effect are found in the effect pages and accessed using [Shift] + [Effects]. This is the secondary function of the mixer button. Effects can also be accessed by pressing [Shift] + [Filter]. Each effect is common for all synth preset audio channels. Effect presets can be saved and loaded in the 'Preset' menu, accessed by pressing [Shift] + [Preset] from within an effect page. A new effect preset can also be initialized and created in this menu.

6.2 Effect Overview

Three effects are available in the master effect section. Each effect has its own page of parameters and can be configured generically. The amount of audio sent to the effect is controlled in the mixer page.

MOD



MOD is an all-round modulation effect similar to a dual delay line effect but better suited to chorus and flanger styles. MOD has four models in order to enable various stereo / mono and multi tap configurations.

DEL



Classic 1 or 2 delay line effect which also supports mono or stereo delays. Five models are available which enable the configuration of single or multi-tap delays as well as developing mono or stereo setups. DEL has a built in filter in order to control or emphasise specific frequency bands.

REV



A Reverb emulate the behavior of a room, its walls and absorbency of sound within its contents. Three models are available with REV which enable the configuration of standard delay styles using the 'Natural' option, Classic 'Plate' delay emulation and a less predictable 'Warp' model.



Hold [Shift] + press [Effect] button to open the effect pages



Alternatively, hold [Shift] + press [Filter]

6 Effects & Modulation

6.3 MOD Effect

NOTES

Access to the MOD effect is available in the effects section under page 1. This is the parameter settings for the master effect which will be applied to the audio send from any of the 3 synths.

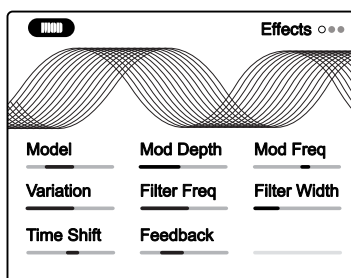

MOD Master Effect - Page 1

Model	Mod Depth	Mod Freq
Options	0-100%	-100Hz to +100Hz
Single delay mono, Dual - dual tap single delay - mono, Stereo dual tap, Stereo X with cross channel feedback.	Amount of mod effect applied.	Speed of mod effect applied.
Variation	Filter Freq	Filter Width
0-100%	20Hz - 20kHz, Off	0-5 Octaves
Adds variation to the parameters. Model dependant.	Feedback loop bandpass filter cutoff frequency.	Spread of the frequency band for the bandpass filter.
Time Shift	Feedback	
-45ms to +45ms	-90% to +90%	
Amount of delay time applied in the effect loop. Phase is shifted for negative settings.	Amount of feedback applied in the effect loop. Phase is shifted for negative settings.	

Mod Concepts

Mod is not a standard effect; however, it is based on the same core concepts used in a delay effect model. Mod has two delay lines and a bandpass filter added to the feedback loop. This configuration better serves time-based applications such as chorus, phaser, and flanger.

6.4 DEL Effect

Access to the master DEL effect is also available in the effects section under page 2 which contains the parameter settings for the this effect.

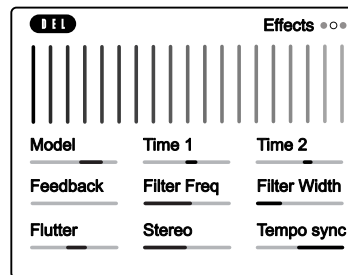

DEL Master Effect - Page 2

Model	Time 1	Time 2
Options	ms or Intervals	ms or Intervals
Single, Dual tap, Triple tap - single delay line models. Stereo & Ping Pong dual delay line models.	Sets the delay time for delay line 1. Resolution dependant on the Tempo Sync mode.	Sets the delay time for delay line 2. Resolution dependant on the Tempo Sync mode.
Feedback	Filter Freq	Filter Width
0-150%	20Hz - 20kHz, Off	0-5 Octaves
Amount of feedback introduced into the delay.	Feedback loop bandpass filter cutoff frequency.	Spread of the frequency band for the bandpass filter.
Flutter	Stereo	Tempo Sync
-100% to +100%	0-100	On/Off
Adds a tape style variation effect to the delay.	Adjusts the width of the delay effect.	Selects the synchronisation of the delay on or off. Affects the time division settings.

Delay Concepts

A delay is a commonly used audio effect that delays an incoming signal to the output. When feedback is applied, this creates a repeated echo-like effect. Multiple tap delays capture the buffered audio at different time intervals.

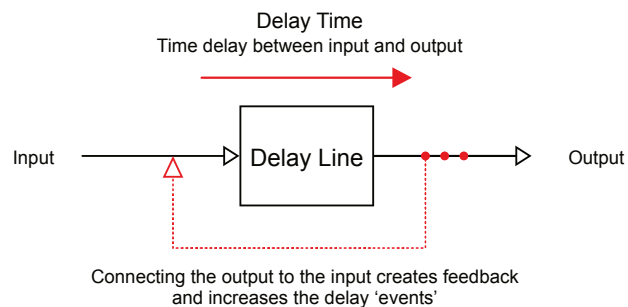

6 Effects & Modulation

6.5 REV Effect

NOTES

The master REV effect is available in the effects section under page 3 along with its associated parameters.

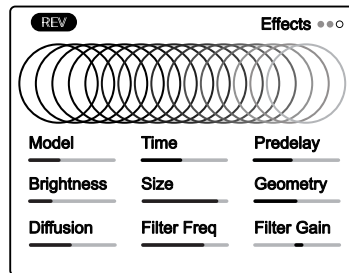

REV Master Effect - Page 1

Model	Time	Pre-delay
Options	0-100	0-100
Natural, Plate or Warp style reverb models	Overall reverb time.	Initial early stage reflections in the reverb.
Brightness	Size	Geometry
0-100	0-100	0-100
EQ application to dampen the feedback loop's high frequencies.	Affects the size of the room space in the reverb algorithm	Affects the room geometry and shape in the reverb algorithm.
Diffusion	Filter Freq	Filter Gain
0-100	100Hz to 10kHz	-25dB to +24dB
Thickness of the reverb sound. Start with a setting of 50-80 and adjust from there.	Shelf Filter frequency to add character and affect the tone of the reverb effect.	Boosts or attenuates the frequencies of the filter shelf.

Reverb Concepts.

A reverb emulates the audio behavior of spaces. Think of how the sound reflects in a large cathedral compared to a small room and how furniture absorbs or reflects sound. The sound will bounce and reflect between the walls and other elements in the room. These reflections arrive at the human ear at different times and different levels.

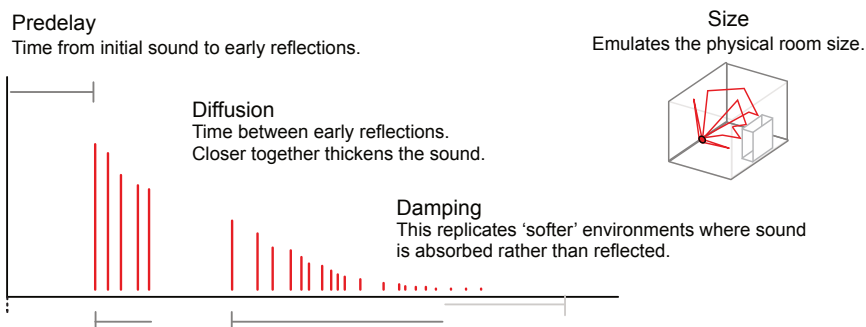

6.6 Using the Effects

The audio send controls synth audio routed to the effects and audio sent between effects. These are controlled in the mixer pages. The master effect parameters for each individual effect are found in the effect page. The master effect settings will apply to all audio sent from a synth or another effect to that specific effect.



Press [Mixer] button to open the effect sends page

Mixer
Mixer page 1
Press [Mixer] to open the mixer page

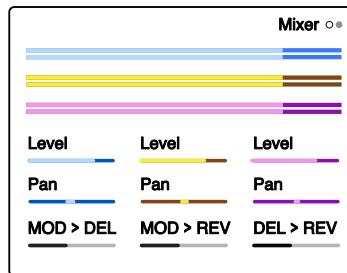

Amount of audio sent from each effect into another effect can be adjusted with the bottom 3 Parameter knobs.

Sends
Mixer page 2
Tap [Mixer] to cycle to the sends page

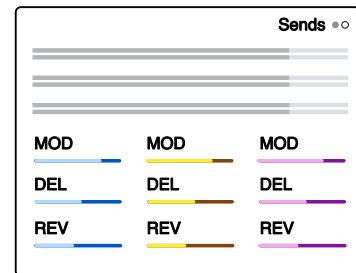

Amount of audio sent from each synth to each effect can be adjusted with the 9 Parameter knobs.

ADJUSTING THE SEND AMOUNTS

1. Open the 'Sends' page. Press [Mixer] to open the mixer and tap the [Mixer] button to cycle the pages. Page 2 is the sends page.
2. Each synth is represented along with each effect. The 9 parameter knobs are used to adjust the amount of audio for each synth that is sent to the effect. It is good practice to adjust by ear but the defined send range is -90 dB to 0dB.
3. If required the effects can be chained, and audio routed from one effect into another. This option is available in the mixer page 1. Tap [Mixer] to select this page. The amount of audio channelled from one effect to another is set using the bottom 3 parameter knobs.
4. The effect sound will be dependant on the settings in the master effect itself. The effect settings can be changed in the master effect pages. These are accessed using [Shift] + [Effects] or [Shift] + [Filter] to cycle through the 3 effects. The 9 parameter knobs adjust the settings which will be applied to all incoming audio from synths or other effects.

6 Effects & Modulation

6.7 Mixer Page

NOTES

The mixer is the central control of the collective audio levels and panning of each synth output. These settings are on page 1 of the mixer.



Press [Mixer] button to open the effect sends page

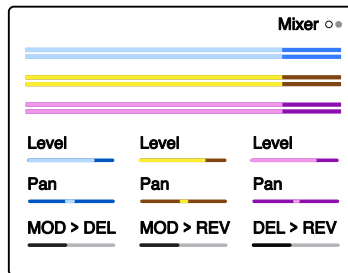

Mixer - Page 1

Level	Level	Level
-90dB to +12dB	-90dB to +12dB	-90dB to +12dB
Audio level output for Synth slot 1 - Blue. Meter bar turns red when audio clips.	Audio level output for Synth slot 2 - Yellow. Meter bar turns red when audio clips.	Audio level output for Synth slot 3 - Purple. Meter bar turns red when audio clips.
Pan	Pan	Pan
L100 - C - R100	L100 - C - R100	L100 - C - R100
Audio pan position within the stereo left to right field for Synth slot 1 - Blue	Audio pan position within the stereo left to right field for Synth slot 2 - Yellow	Audio pan position within the stereo left to right field for Synth slot 3 - Purple
MOD > DEL	MOD > REV	DEL > REV
-90dB to +12dB	-90dB to +12dB	-90dB to +12dB
Amount of audio routed from the mod effect output and into the delay effect	Amount of audio routed from the mod effect output and into the reverb effect	Amount of audio routed from the delay effect output and into the reverb effect

The mixer page will be frequently visited while adjusting the synth balance of the synth voices during the sound design process. It will also be used to finalise the output mix when the patch and scene are close to completion.

6.8 Modulation Overview

Modulation is the process of controlling and affecting one or more parameters from the behavior of another function. For example, an LFO can vary the volume in a tremolo-style effect. Some interesting combinations can contribute to the creative approach to sound and preset design. Synth has a dedicated modulation matrix that enables the connection and routing of functions.

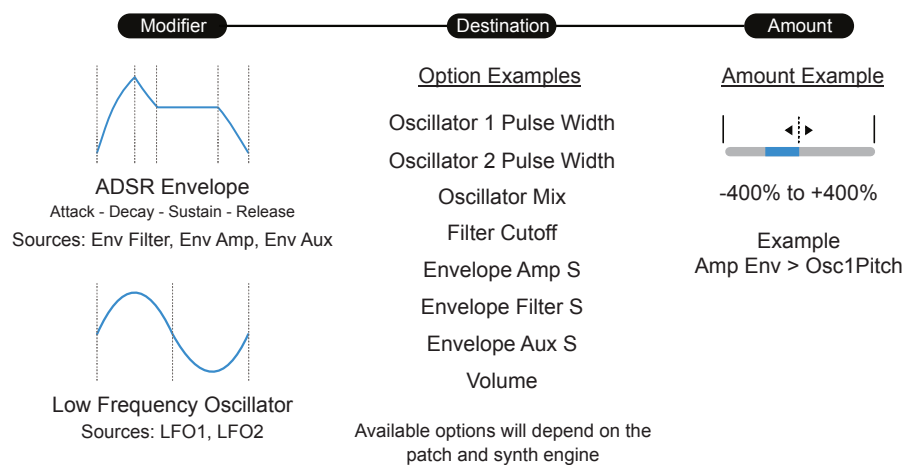

Modifier:

The modifier is the modulation source and is the function which controls and modifies the destination parameter. For example an LFO - low frequency oscillator or an envelope.

Destination:

The destination is the specific parameter that will be modulated and affected by the modifier. It is the parameter that is changed. Example Osc1 Pitch.

Amount:

The amount of modulation applied to the destination parameter. Typically a bipolar range. Affects how much impact on the destination from the modulator.

6 Effects & Modulation

6.9 Applying Modulation

NOTES

The modulation matrix contains six configurable modulation channels for each synth. Some synths, like ACD, have predefined, fixed configurations. The source can be either an LFO or the aux envelope. Based on the synth engine and configuration currently selected, a variety of parameter destinations are available.

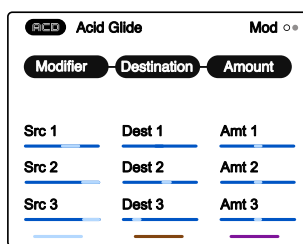
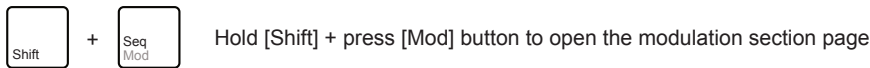

Turn the respective parameter knob to change the setting for each of the three modulation functions.

Mod

Src 1	Dest 1	Amt 1
LFO or ADSR Envelope	Engine Dependand Options	-400% to +400%
Select the source modifier function for modulation channel 1.	Select the target destination parameter to modulate from channel 1.	Amount of modulation applied from the channel 1 modifier to the destination.
Src 2	Dest 2	Amt 2
LFO or ADSR Envelope	Engine Dependand Options	-400% to +400%
Select the source modifier function for modulation channel 2.	Select the target destination parameter to modulate from channel 2.	Amount of modulation applied from the channel 2 modifier to the destination.
Src 3	Dest 3	Amt 3
LFO or ADSR Envelope	Engine Dependand Options	-400% to +400%
Select the source modifier function for modulation channel 3.	Select the target destination parameter to modulate from channel 3.	Amount of modulation applied from the channel 3 modifier to the destination.

Functions are repeated for Src 4, 5 and 6 found on page 2

6.10 Levels & Gain Staging

It is an iterative process when gain staging and balancing the volume levels through the audio path. Going back and forth to ensure the output is loud enough to be appropriate while avoiding the audio being too 'hot' where clipping distorts the signal.

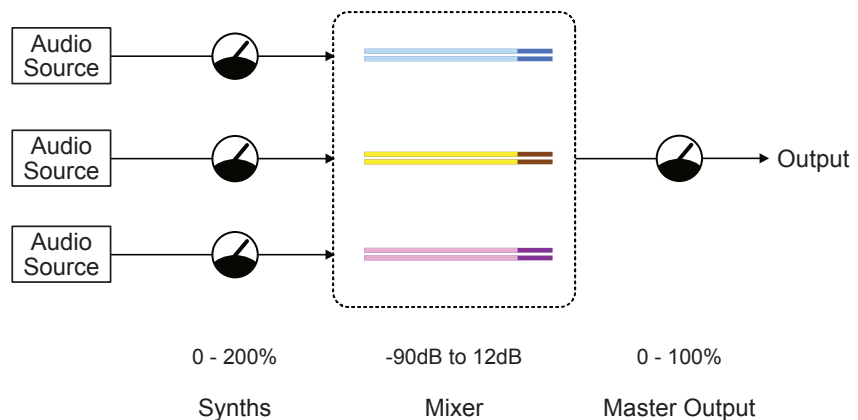

A good starting point is to set the master output at around 75% to give a level of headroom for general volume adjustment. Then, set the mixer levels for each synth to -6dB. The synth output audio can be adjusted along with the tweaking and tuning synth parameters. Maybe start at 100% for each synth.

Adjusting and iterating between the synth and mixer is good practice, with the master output used purely to control the scene's master volume level.

7

Sequencer & Arp

Two functions that automate pattern generation are available for each synth. The sequencer is a utility that records a melody of up to 64 notes and allows this to be played back with a set of parameters that affect the behavior. Note increments, length, as well as swing, and humanization can be controlled. Notes would be recorded using the pads and also are used to trigger the playback of notes respective to the pad note played. Additionally, an arpeggiator is available to generate a sequential pattern of notes from a chord. The arp behavior can also be controlled. Pads are also used to play a chord or selection of notes from which the arp generates a pattern. The chord groove function is available to both the sequencer

and the arp, which consists of 11 style templates that apply note sequences and rests to create.... well... a groove. The sequencer and arp can also be turned off, and the pads are simply used to generate notes. The sequencer and ARP settings are saved and recalled with the scene.

7 Sequencer & Arp

7.1 Sequencer & Arp Overview

NOTES

Synth has a built-in sequencer and arpeggiator per engine slot. The sequencer page has options to record and playback note patterns and set the sequencer's behavior. Use the [Seq] button to select the options.

An arpeggiator generates a note pattern by breaking a chord into discrete notes and then playing these notes in a cyclic pattern. A sequencer is a function that is used to record a pattern from the notes played. These can then be played back as a continuous pattern.

The sequencer and arp parameters govern the pattern playback behavior. Only one arp or seq function can be applied per synth.



Press [Seq] button to open and cycle through the Off, Arp and sequencer pages.



Page 1 - Sequencer Off

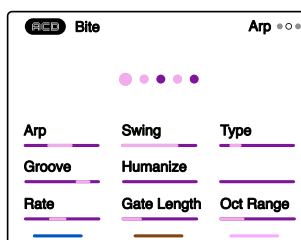

Page 2 - Arp On

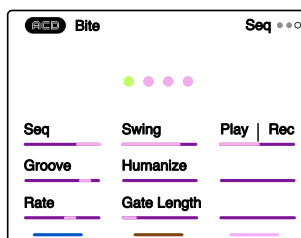

Page 3 - Sequencer On

MIDI Transport:

The sequencer and arp are also affected by the tempo or the internal clock. Also the incoming MIDI transport settings will determine how external play / stop are handled.

7.2 Sequencer Overview

Synth has a built in sequencer and arpeggiator. The sequencer can record up to 64 notes and then play back the recorded note patterns. There are several parameter option which are used to control the sequencer behavior. The sequencer is found on page 3.

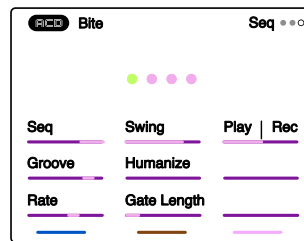

The recorded pattern is represented by the central dots. If no sequence is present a 'No Sequence' message is displayed.

- Recording mode, cursor step
- Playback mode, cursor step
- Recorded notes (colour of synth)
- Recorded rests (dim colour of synth)

Sequencer

Seq	Swing	Play / Record Mode
Select	Global 50% - 75%	Mode Select
Select the source modifier function for modulation channel 1.	Adds an amount of variation by shifting some notes slightly off grid to play earlier or later.	Select 'Rec' to record a sequence using the pads. Once recorded, select 'Play' to use the pads to play back the recorded pattern at the selected pad note pitch.
Groove	Humanize	
1-11	0-100%	
Selects a groove template 1-11 in order to apply to the arpeggio or sequence pattern.	Adds a human shuffle or rhythmic feel to the generated arpeggio or pattern.	
Rate	Gate Length	
Options	1% - 200%	
Selects the note interval for the arpeggio. See table below for options.	Length of each note in the sequence pattern.	

Rate Intervals:

1, 1/2D, 1T, 1/2, 1/4D. 1/2T, 1/4, 1/8D, 1/4T, 1/8, 1/16D, 1/8T, 1/16, 1/32D, 1/16T, 1/32, 1/64D, 1/32T, 1/64

7 Sequencer & Arp

7.3 Using the Sequencer

NOTES

The sequencer can record notes manually played on the pads when in record mode. The parameters are then applied when playing the recorded sequence back. The recorded notes are displayed as dots on the display.

Display format

The active step is shown green when in playback mode and red when in recording mode. Other active steps are based on the colour of the synth selected.

Play

Play | Rec

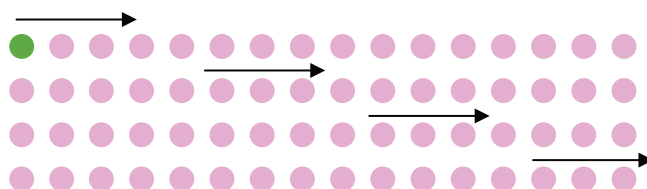

The Sequencer can record up to 64 Steps per Synth.

Record

Play | Rec



Notes are recorded in 'Rec' mode using the synth pads. Notes are recorded and played left to right, top row first and will loop back to the start from the last step.

Clear Pattern

Play | Rec

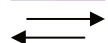

Switch to record and back to play, without recording, to clear a pattern.

Example

8 Note pattern

Play | Rec

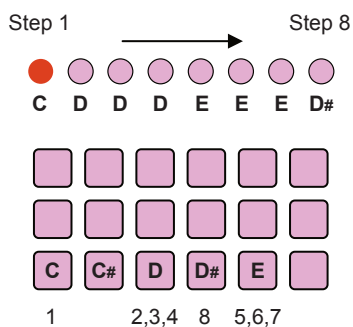

Sequence or arp patterns are saved with the scene.

Tap [Shift] to add a rest.

When notes are recorded the rate, timing etc can all be adjusted afterwards during playback while auditioning the pattern.

Sequencer patterns are saved for each synth with the scene. Creating a sequence pattern is performed in [Seq] mode using the pads. Once created, a sequenced note pattern cannot be edited, but the sequence parameters can be adjusted.

RECORDING A SEQUENCE

1. Select the synth to edit. Press the screen button.
2. Open the sequencer page. Press [Seq] to cycle to the Seq Page 3. Alternatively in the sequencer page, turn the first, top left parameter knob to select between Off, Arp, Seq On. Any previous pattern is retained when switching from Off.
3. If required, a sequence can be cleared at any time. Turn the [Play | Rec] knob to 'Rec' mode, then, without recording a pattern, turn back to 'Play.' The pattern is cleared and a 'No Sequence' is displayed.
4. To record a pattern, turn [Play | Rec] parameter knob to 'Rec' mode. The active step will be coloured red.
5. Play the pads of the selected synth. Each pad will record the respective note into the sequencer pattern. Steps will automatically increment up to a maximum of 64 notes. At this stage, the note value and melody are most important. If required, tap [Shift] to add a rest on a step.
6. Once the pattern is recorded, turn [Play | Rec] parameter knob to 'Play' mode. The active step will be coloured green and the pattern locked in.

PLAYING AND EDITING A SEQUENCE

1. Once a pattern is recorded and 'Play' mode is active, the pattern can be played. Press [Pad] to play the sequenced pattern. If pressing the original first pad, the notes will be the same as recorded or can be offset by notes relative to any other pad played. If MIDI transport is configured this may affect the sequencer playback.
2. The sequence behavior can be edited. It is useful to lock playback using [Shift] + [Pad] then adjust or tweak the parameters. As a tip, start with the rate and note length, then try the swing, humanize and groove settings to find an appropriate melody.
3. To save a sequence, save the scene. Sequenced patterns are saved for the synths with the scene.

7 Sequencer & Arp

7.4 Arp Overview

NOTES

Synth's arpeggiator can loop a series of individual notes taken from a played chord or collection of notes into an arpeggio. Several parameter options are used to control the arp behavior. The arp is found on page 2

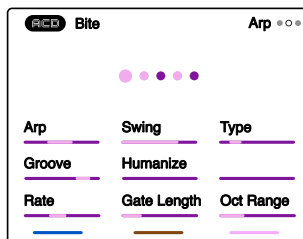

Each note is represented by the central dots, minimum of 1. Groove will determine notes / rest sequence.

- 1st Note (colour of synth)
- Arpeggiated notes, smaller dots
- Rests, smaller, dimmed steps

Sequencer

Seq	Swing	Type
Select	50% - 75%	Options
Select the source modifier function for modulation channel 1.	Adds an amount of variation by shifting some notes slightly off grid to play earlier or later	Playback Behavior. Options are: Up, Down, Play Order, Random, Chord, Dyad, Triad, Inside out, Outside in, Up Down, Down Up, Weave, Return, Double Return.
Groove	Humanize	
1-11	0-100%	
Selects a groove template 1-11 in order to apply to the arpeggio steps and pattern.	Adds a human shuffle or rhythmic feel to the generated arpeggio.	
Rate	Gate Length	Oct Range
Options	1% - 200%	1-8
Selects the note interval for the arpeggio. See table below for options.	Length of each note in the sequence pattern.	The number of octaves used to play the arpeggio. Plays back the notes across the selected octave range

Rate Intervals:

1, 1/2D, 1T, 1/2, 1/4D. 1/2T, 1/4, 1/8D, 1/4T, 1/8, 1/16D, 1/8T, 1/16, 1/32D, 1/16T, 1/32 1/64D, 1/32T, 1/64

7.5 Using the Arpeggiator

The arp does not record notes, but breaks a chord or note group down into discrete patterns while being played. The arpeggio pattern generated will be based on the parameter configuration.

Playback options

Playing a chord will generate an arpeggio. How this behaves depends on the parameters, starting with the 'Type' which determines the direction and sequence of notes and 'Groove' for notes and rests.

Groove

- Notes
- Rests

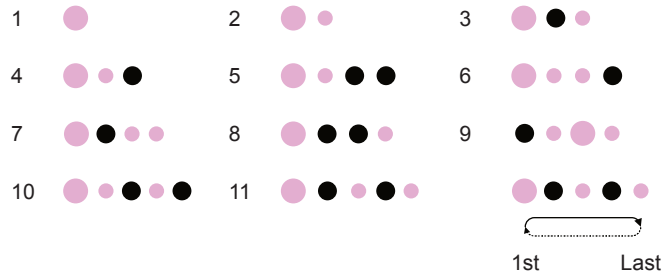

Type

- 1 1st Note
- Note or Note Repeat
- Rest
- ● Groove 4

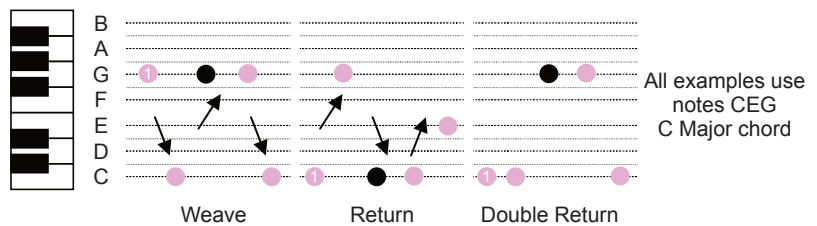
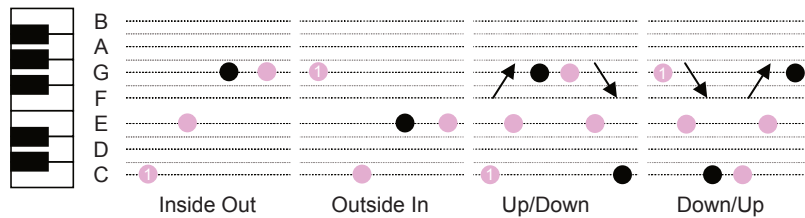
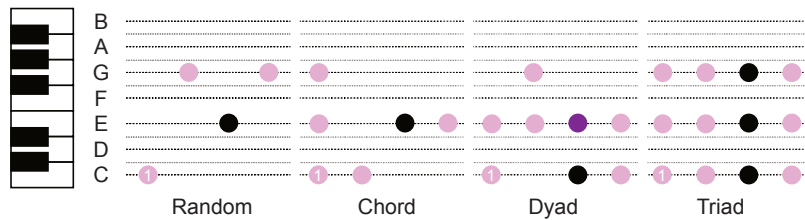
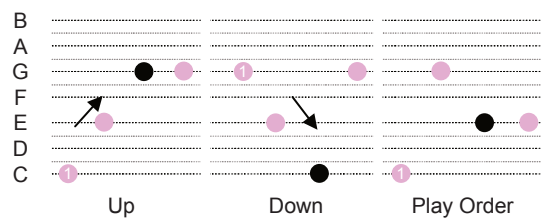

7 Sequencer & Arp

Arp patterns are saved for each synth with the scene. The process of creating an arpeggio is performed in [Seq] arp mode using the pads. Once created, the arp parameters can be adjusted.

■ CREATING AN ARPEGGIO

1. Select the synth to edit. Press the screen button for the selected synth.
2. Open the arp page. Press [Seq] to cycle to the seq page 2. Alternatively in the sequencer page, turn the first parameter knob to select between Off, Arp, Seq On. Any previous pattern is retained when switching from Off.
3. An arpeggio is only created when a selection of pad notes are held or locked. It is good practice to lock pads for a chord using [Shift] + [Pad]. Once a chord is played or locked the arp can be set.
4. Start by setting the rate and gate length. These will determine the speed of the notes and the length of each.
5. Select one of the groove templates by turning (Groove). The rests will be shown as dimmed dots and bright dots are notes. This determines the sequence played.
6. Adjust (Type) to select the direction of the arpeggio pattern. This sets the order that the notes will play and loop.
7. Finally the swing and humanize settings can be adjusted to add some natural rhythm and shuffle to the pattern.
8. To save an arp setting, save the scene. Arp settings are saved for the synths with the scene.

NOTES

8

MIDI & Connectivity

Almost all sections to this point have concentrated on using Synth inside the box. It is, after all, a self-contained, multi-engine polyphonic synthesizer. However, it can also interface well with other gear. Connectivity to address these functions comes from the application of MIDI using the USB connection or via the dedicated TRS MIDI In/Out ports. These can be connected to the standard 5-Pin MIDI standard with the provided adapter. A typical MIDI application is to control Synth using an external keyboard instead of the onboard pad grid. Also, it is possible to control Synths parameters using control change messaging. Changing presets using program change messages is also possible with the added benefit of the

ability to map up to 8 specific presets for each loaded Synth to an incoming MIDI PC message. This offers an exciting and inspiring live performance feature and speeds up set changes when required. Synths MIDI connectivity expands the system possibilities with the ability to connect to audio software such as DAWs and plug-ins, as well as a variety of desktop audio gear.

8 MIDI & Connectivity

8.1 MIDI Terms

NOTES

To clarify some of the generic terminology and technology around MIDI, a summary of key definitions is provided. Synth uses a Type B, TRS to MIDI adapter. Also MIDI over USB is possible.

5 PIN MIDI



5 PIN to TRS MIDI



MIDI DIN 24

This is often found for MIDI Out and Thru and enables syncing of devices. This uses 0v & 5v messages as sync signals at 24 pulses per quarter note (PPQN) as a MIDI standard.

MIDI DIN 48

This is used for MIDI Out and Thru and enables syncing of classic devices. This uses 0v & 5v messages as sync signals at 48 pulses per quarter note (PPQN). Less common in modern synths.

MIDI

Musical Instrument Digital Interface. A protocol for communicating between electronic musical gear. Never connect MIDI gear to incompatible DIN signals. Synth has USB MIDI but also an interface for 5 Pin DIN In and out.

MIDI CC

MIDI Continuous Control change messages are used to communicate messages across MIDI with values of 0-127. CC Changes affect parameter values while note data triggers notes. Synth has some defined CC assignments.

MIDI PC

MIDI Program Change allows presets or banks to be controlled over a MIDI connection. Synth recognises PC messages to select the current Synth preset.

MIDI STANDARDS

While there are MIDI standards defined, many synth developers interpret this in slightly different ways. Its always worth reviewing the documentation with each to fully understand each device level implementation.

NRPN

Non-Registered Parameter Number is part of the MIDI standard. CC and NRPN are technically very similar but NRPN is less well defined in the standards. NRPN uses more data and can give better control. Not supported by Synth.

SYSEX

System Exclusive. This is an expansion of the normal MIDI communications set up and is typically used for transferring data such as back ups, patches, presets and firmware updates to and from devices. Not supported by Synth.

MSB & LSB

Most Significant Byte and Least Significant Byte. MSB provides the 128 data resolution which is ok for most MIDI applications. More advanced devices use MSB and LSB values increasing resolution to 16,384 steps.

The term 'primary lead' will refer, in this guide to a device that has the main control responsibility. For example controls the clock and transport and is the central lead. A device which will be controlled by, and follows the primary lead device and which will be subservient by responding to the main control messages will be called a 'secondary follower'.

8.2 Basic MIDI concepts for Synth

Synth has a MIDI USB plus a MIDI TRS input and output in order to connect between compatible devices. The settings for MIDI are found in the main menu under the MIDI sub-menu. The notes of the synth can be controlled by an external MIDI keyboard plus control change CC and program change PC messages can be received.

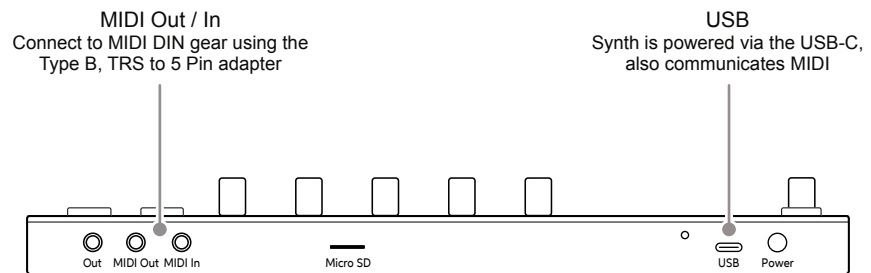

The following points should be considered and questions answered when working with MIDI configurations:-

- How the devices are connected together? Are the devices connected by USB? Which will transmit and receive MIDI with the MIDI 5 Pin connection using the MIDI jack adapter? Synth can use one or the other or both.
- Which device will be a primary leader (main device e.g. controls the main clock) or a secondary follower (will respond to other gear e.g. synchronised to another clock)? Synth will issue a warning message if the external MIDI clock assigned from the primary device is lost or is disconnected.
- When Synth receives a MIDI clock the tempo will reflect the external controller BPM. Synth can also send a clock out. Also incoming transport for play / stop and Synths MIDI settings will affect the sequencers.
- The default CC configurations in Synth are pre-defined. Check the device MIDI mappings for each connected device in the manufacturers documentation.
- Synth does not support MIDI NRPN or Sysex messages.
- Synth operates internally with 96 PPQN - Pulses Per Quarter Note for MIDI Timing but communicates at 24 PPQN.

8 MIDI & Connectivity

8.3 MIDI Configuration

NOTES

MIDI Settings are accessed in the main menu by pressing (Screen) knob. These will dictate if Synth leads on functions like clock and transport or if it acts as a secondary follower, responding to control and synchronisation from another primary device control. Synth would typically be controlled by an external controller to operate the three synths remotely.

Menu	Option	Description
MIDI	Clock in	Sets the Synth clock input for using the 'Internal' clock (default). Options for external clock received through the 'MIDI in USB' or 'MIDI In jack' input. Tempo reflects external device BPM and may display 'EXT' when set external. Manual BPM changes are not possible when an external tempo is detected.
MIDI	Transport in	Sets the transport in port. Off (default), or select control from an external device, received through the USB or MIDI In jack.
MIDI	Clock out	Sends the Synth clock output to other devices. Off, USB, MIDI Out jack or USB+MIDI jack options.
MIDI	Wait for start (Ext transport in)	Selects if the transport incoming messages control the sequencer and synth start functions. Set to Off or On. This ensure transport, rather than just a clock starts the sequencer or arp.
MIDI	Control change mapping	Opens the synth engine page with the displayed CC assignments. This is a visual indicator of the mapping.

MIDI PC - Program change mapping is setup in the scene setting options

ACCESSING THE MIDI CONFIG OPTIONS

1. Press (Screen) knob to open the configuration menu.
2. Turn (Screen) to navigate the menu and highlight 'MIDI'. Press (Screen) to select the menu option.
3. Turn (Screen) knob to highlight the MIDI option and press (Screen) to select the options menu. Turn to navigate and then press (Screen) to set the parameter value.
4. The CC mapping option opens the synth pages with the CC number shown in parenthesis (), alongside the parameter. Press (Screen) knob to backup in the CC mapping pages.

External Clock:

When configured for an external clock, the arp or sequencer will be affected and sound will not be generated if the clock is not detected. A 'No external clock' message will be displayed. Wait for start exists specifically because some devices send clock messages constantly, regardless of playback state. Which is why this setting exists. It ensures that the arp/sequences are only running when an actual start message is received.

8.4 External Keyboard Configuration

An external device, keyboard, or drum pads can be connected to control the Synth by MIDI, either using the USB or via the MIDI TRS / 5 Pin MIDI adapter. Notes can be controlled from an external keyboard to play the notes of each of the three synths.

Example configuration 1: Synth as the secondary follower controlled with Arturia Minilab.

MIDI IN

USB MIDI

Main Menu > MIDI

Clock In	MIDI In Jack
Transport in	MIDI In Jack
Clock out	Off
Wait for Start (Ext Transport in)	Off
Control Change Mapping	

Main Menu > Synths

Synths		
Voices	Voices	Voices
4	1	1
Midi I/O	Midi I/O	Midi I/O
Jack #1	Jack #2	Jack #3
Local Mode	Local Mode	Local Mode
On	On	On
ACD	ACD	ACD
Back	More	

Main Menu > Synths more

Synths		
Pad Mapping	Pad Mapping	Pad Mapping
All	Off	White Keys
Base Note	Base Note	Base Note
C 4	C 4	C 4
ACD	ACD	ACD
Back	More	

Local mode:
 On - the synth pads are playable, controlling
 Off - the synth pads are disconnected allowing only the external controller to play notes in Synth.

Pad Mapping:
 An external MIDI Controllers keys or pads can be mapped to Synths pads and aligned with the base note.
 Off - No pad mapping.
 All - All incoming notes mapped to the pads.
 White Keys - Only the white keys of the controller are mapped. Black keys will play the nearest white note.

MIDI OUT

This setup would require the external controller to be set to channel 1, 2 or 3 to match the selected synth channel shown in the example. Synth channels can be changed in the 'Synths' sub-menu as well as mapping keys / pads to the Synth pads.

Keyboard or pad controller for MIDI note information on the channel to match that of the synth to control i.e. channel 1.

Polyend Synth Manual

127

8 MIDI & Connectivity

8.5 External Control Change Messages

NOTES

An external MIDI device can be connected to control Synth by MIDI to send CC messages. CC or control change messages are used to control assigned parameters, adjusting the values remotely.

Example configuration 2: Synth as the secondary follower controlled with Faderfox EC4.

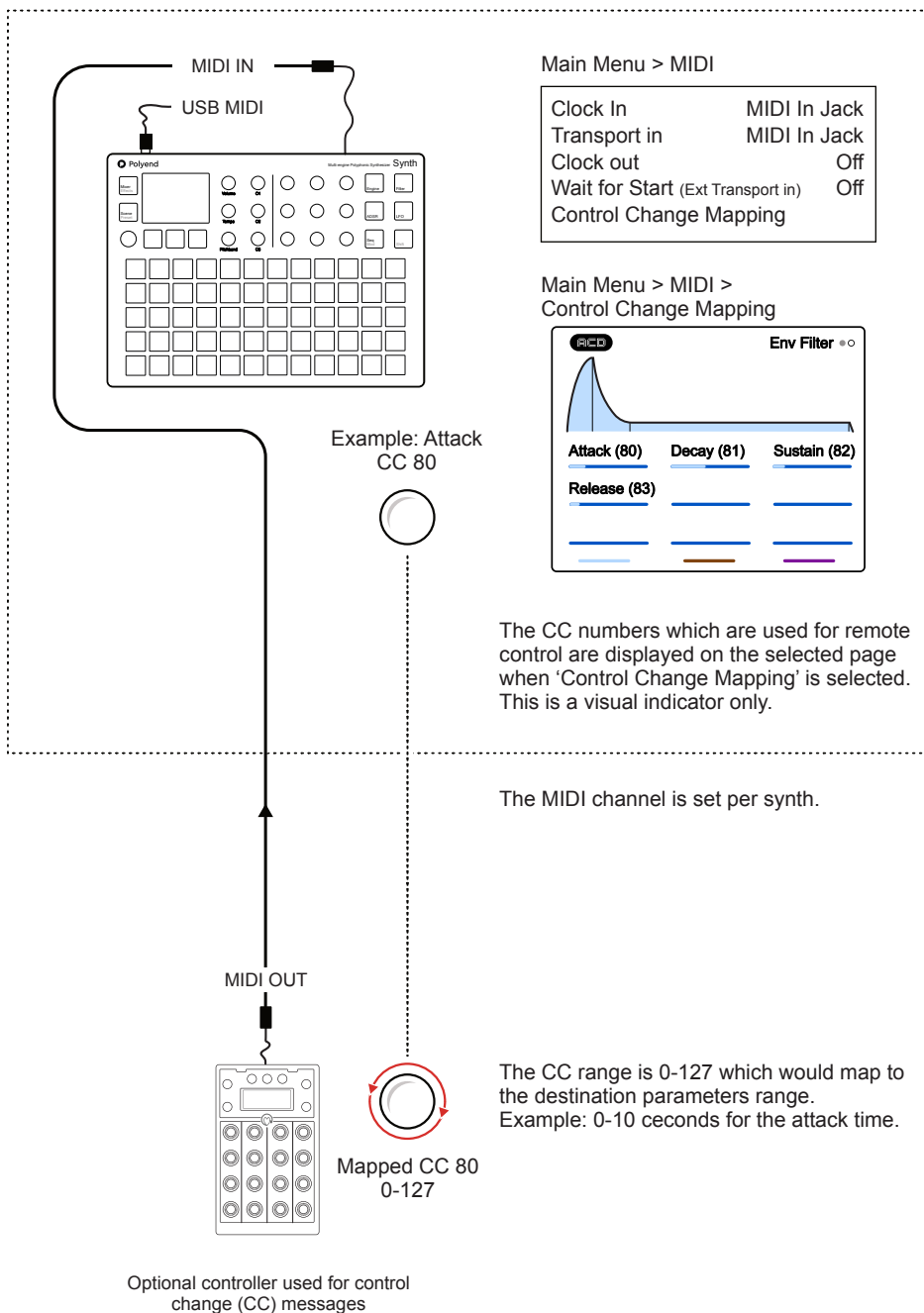

Setting up CC messaging will need configuration in Synth as well as configuration in the connected device. Refer to the connected devices documentation. Synth has preset CC mapping assigned to specific parameters in the synth engine functions.

CONNECTING AN EXTERNAL CC CONTROLLER

1. Ensure the connected device has the ability to configure CC output messages for example using a knob or fader. Typically the CC number to match the destination address and possibly the range which is typically 0-127. Connect the devices using the MIDI or USB connections.
2. Ensure the Synth to control is set to the same MIDI channel as the external device. Press (Screen) to open the main menu. Navigate to the 'Synths' menu and press (Screen). Use the parameter knobs to set the 'Midi Channel' port and number.
3. Select a function page to control. For example, select the [ADSR] envelope page for filter. The current setting will be the starting value.
4. To view the CC numbers assigned to the synth parameters, open the main menu by pressing (Screen). Turn (Screen) to navigate to the 'MIDI' option and press (Screen). Open the 'Control Change Mapping' option by pressing (Screen) when highlighted.
5. The control change mapping page shows the parameters for the selected function. The parameter titles will be followed by a number in brackets, i.e. (80) for attack time for the filter ADSR Envelope. This is a visual reference only and displayed parameters cannot be changed.
6. Ensure the external MIDI device control parameter is set to send CC messages to same number i.e. 80. The external range is typically 0-127 which will control the destination. For example, attack time will vary between 0-10 seconds with the 0-127 range.

For controlling external devices from Synth It is also possible to create MIDI Mappings of CCs and save and load these as presets. This is performed using the MIDI instrument which is found in the Synth presents under the engine section. Details are covered in the synth section.

8 MIDI & Connectivity

8.6 External Program Change Messages

NOTES

The synth can receive PC program change messages to switch presets remotely. PC control introduces a creative dimension, especially useful for live performances. Up to 8 PC messages can be mapped to dedicated patches and, therefore, changed on-the-fly for the associated synth. This mapping is handled at the scene level.

Example configuration 3: Synth as the secondary follower controlled with Faderfox EC4.

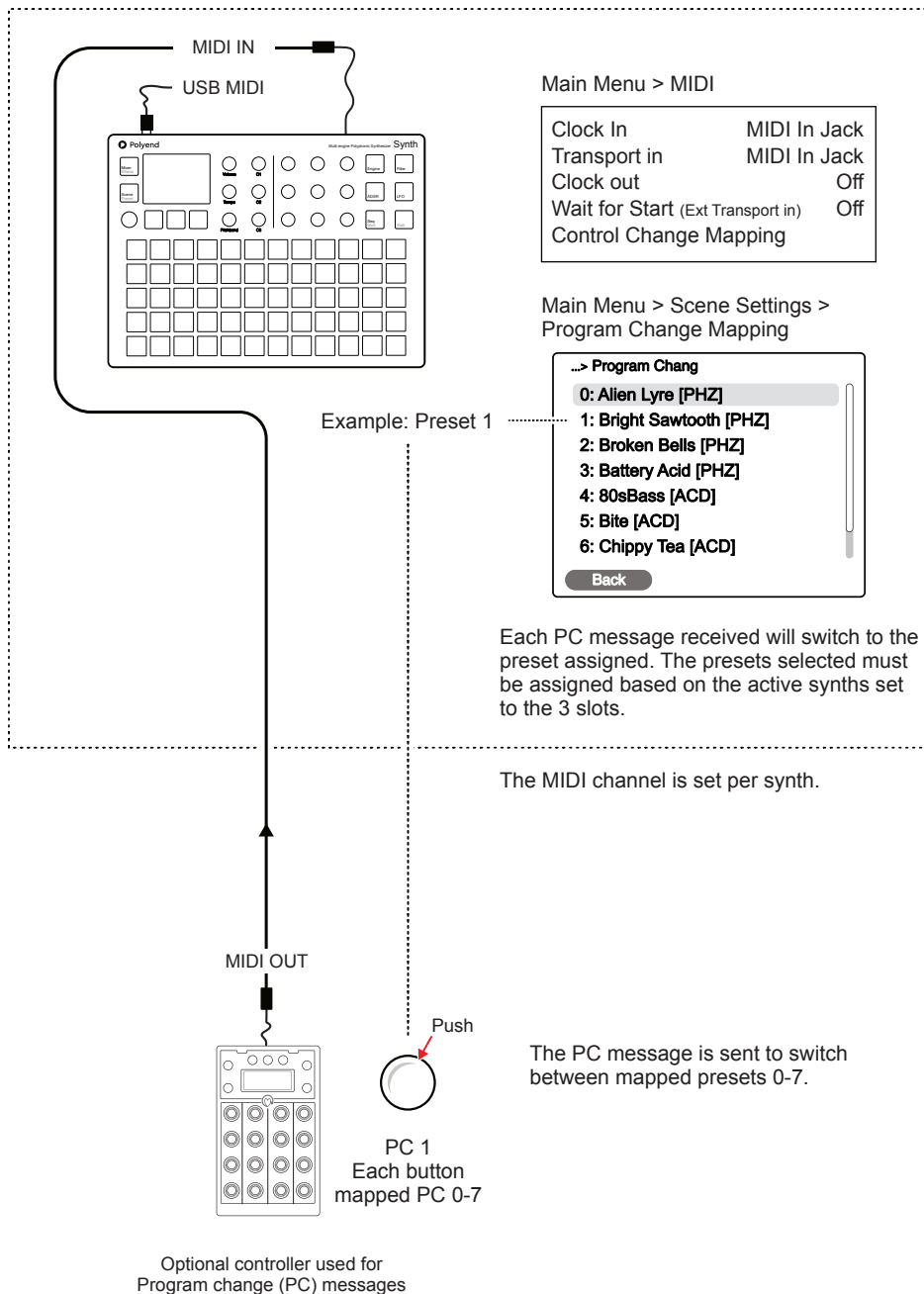

PC messaging is set up in Synth at the scene level. There is only one map for all PC changes, and these will apply preset switching to the 3 loaded synth engines. As such, the chosen presets must be based on the 3 synth engines loaded and the MIDI channel matched. For example, ACD synth presets will only operate when an ACD synth is assigned to a synth slot for the same MIDI channel as the incoming PC message.

CONNECTING AN EXTERNAL PC CONTROLLER

1. Ensure the connected device has the ability to configure PC output messages, for example, with a button or knob. Synth uses PC numbers 0-7 to map to the presets. The external device must be able to send a 0-7 PC message. Connect the devices using the MIDI or USB connections.
2. Ensure the Synth to control is set to the same MIDI channel as the external device. Navigate in the main menu and press (Screen) to open when highlighting the 'Synths' menu. Use the parameter knobs to set the 'Midi Channel' port and number. It is important to set these synth slots first.
3. To map the program change presets, open the main menu by pressing (Screen). Navigate to the 'Scene Settings' option and press (Screen) to select. Open the 'Program Change Mapping' option by pressing (Screen) when highlighted.
4. The program change mapping page shows the list of 8 slots. To map the preset:-
 - With a slot chosen and highlighted, press (Screen).
 - Firstly select an engine, press (*Engines*) and turn (Screen). The engine selected will filter the presets for this synth. The synth must be loaded to a synth slot beforehand. Press (Screen) to choose.
 - Select a preset for the PC slot. Turn (Screen) and highlight a preset. Press (Screen) to assign the preset to the PC slot.
5. When a PC message is received, it will change the preset assigned to the specific synth on the defined MIDI channel.

Note that the PC application can vary between devices. For example, some may start at 0, others at 1, some change banks others change presets or patches. It is advised to test and audition the PC settings between devices to ensure a good matchup. Check whether the external device will send a program change number or if it uses the MSB / LSB values to affect the change.

8 MIDI & Connectivity

8.7 External DAW Control

The ability to connect to a PC or Mac via a MIDI connection is possible, which can allow software DAW's, sequencers and plug-ins to control Synth. Synth will need a hub or will need to be powered by the PC / Mac as the USB connection is also the source of power for Synth.

Example configuration 4: Synth with Ableton Live.

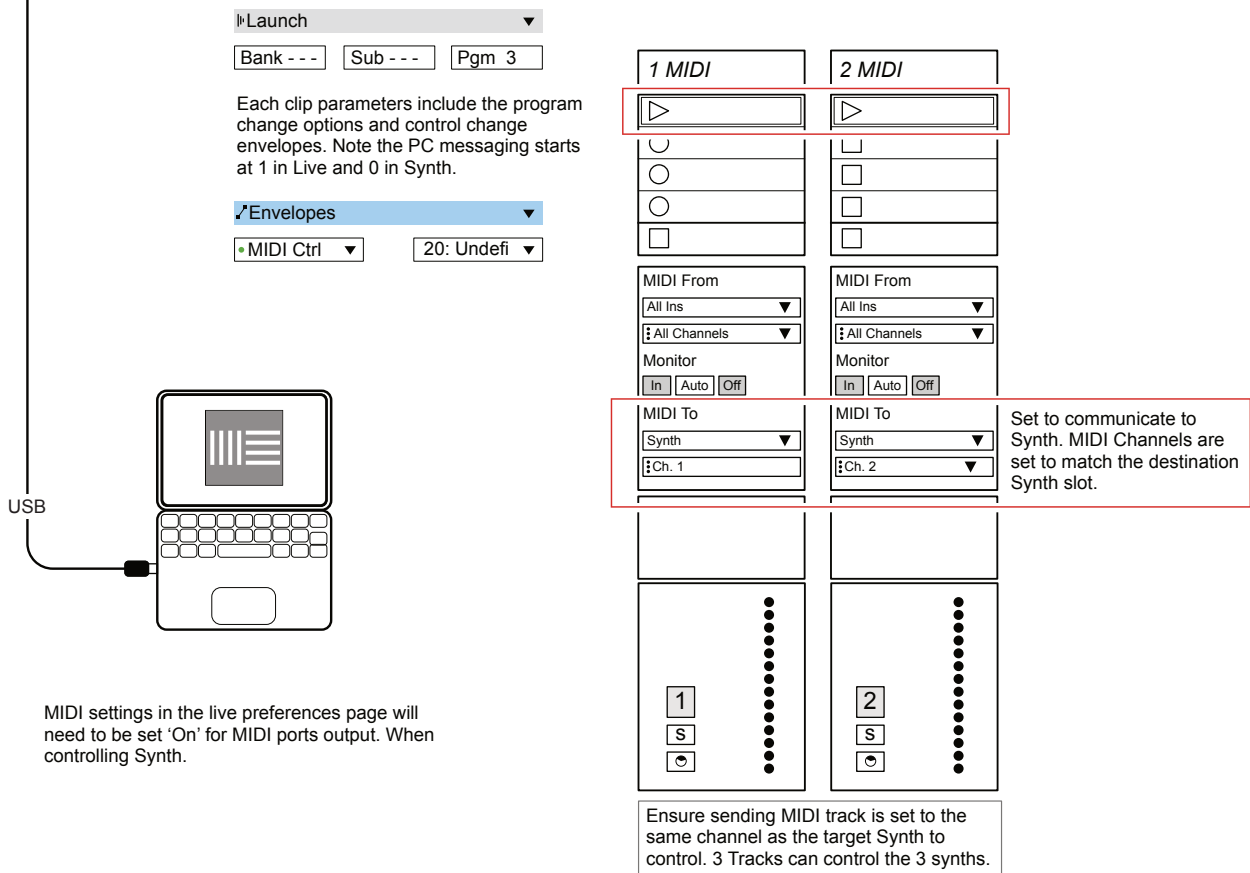
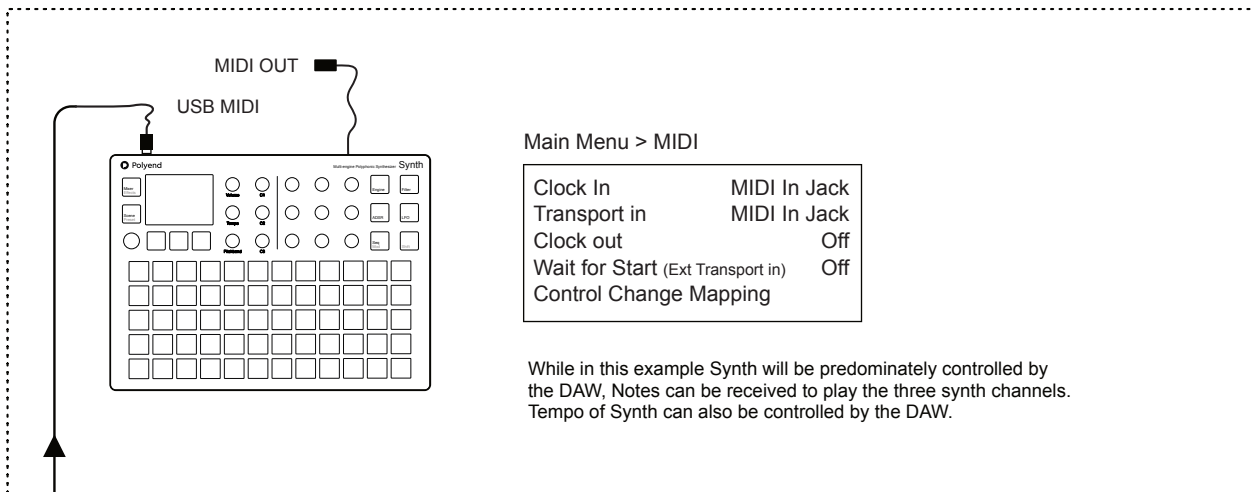

MIDI settings in the live preferences page will need to be set 'On' for MIDI ports output. When controlling Synth.

8.8 MIDI CC Mapping

The mapping is identified in the MIDI CC settings menu. A complete set is covered here and parameters that are not assigned CC values are not listed.

ACD Synth Engine

Function	Parameter	CC Number
Engine	Saw Mix	20
Engine	Square Mix	21
Engine	Sub Mix	22
Engine	Noise	23
Engine	PW	24
Engine	Pitch LFO	27
Engine	PW Env	26
Engine	PW LFO	25

Function	Parameter	CC Number
Filter	Cutoff	74
Filter	Resonance	71
Filter	Env Amount	77
Filter	Filter LFO	78

Function	Parameter	CC Number
Env Amp	Attack	75
Env Amp	Decay	72
Env Amp	Sustain	76
Env Amp	Release	73

Function	Parameter	CC Number
Env Filter	Attack	80
Env Filter	Decay	81
Env Filter	Sustain	82
Env Filter	Release	83

Function	Parameter	CC Number
LFO	Frequency	54

Function	Parameter	CC Number
MOD	Pitch LFO	27
MOD	PW Envelope	26
MOD	PW LFO	25
MOD	Filter LFO	78

FAT Synth Engine

Function	Parameter	CC Number
Engine	Fatness	27
Engine	Brightness	23
Engine	Timbre	20
Engine	Fatness LFO	24
Engine	Noise	21

Function	Parameter	CC Number
Filter	Cutoff	74
Filter	Resonance	71
Filter	Env Amount	77
Filter	Filter LFO	78

Function	Parameter	CC Number
Env Amp	Attack	75
Env Amp	Decay	72
Env Amp	Sustain	76
Env Amp	Release	73

Function	Parameter	CC Number
Env Filter	Attack	80
Env Filter	Decay	81
Env Filter	Sustain	82
Env Filter	Release	83

Function	Parameter	CC Number
Env Filter	Attack	80
Env Filter	Decay	81
Env Filter	Sustain	82
Env Filter	Release	83

Function	Parameter	CC Number
LFO	Frequency	54

Function	Parameter	CC Number
MOD	Fatness LFO	24
MOD	Filter LFO	78

WAVS Synth Engine

Function	Parameter	CC Number
Engine P1	Position 1	22
Engine P1	Position 2	27
Engine P1	Mix	20
Engine P1	Warp 1	21
Engine P1	Warp 2	28
Engine P1	Noise	29
Engine P2	Tune 1	25
Engine P2	Tune 2	30
Engine P2	Detune	31
Engine P3	Finetune	26

Function	Parameter	CC Number
Filter	Cutoff	74
Filter	Resonance	71
Filter	Env Amount	77

Function	Parameter	CC Number
Env Amp	Attack	75
Env Amp	Decay	72
Env Amp	Sustain	76
Env Amp	Release	73

Function	Parameter	CC Number
Env Filter	Attack	80
Env Filter	Decay	81
Env Filter	Sustain	82
Env Filter	Release	83

Function	Parameter	CC Number
Env Aux	Attack	46
Env Aux	Decay	47
Env Aux	Sustain	48
Env Aux	Release	49

8 MIDI & Connectivity

VAP Synth Engine

Function	Parameter	CC Number
Engine P1	Shape 1	22
Engine P1	Shape 2	27
Engine P1	Mix	20
Engine P1	PW 1	21
Engine P1	PW 2	28
Engine P1	Tune 1	25
Engine P1	Tune 2	30
Engine P1	Detune	26
Engine P2	Noise	23
Engine P2	Finetune	31

Function	Parameter	CC Number
Filter	Cutoff	74
Filter	Resonance	71
Filter	Env Amount	77

Function	Parameter	CC Number
Env Amp	Attack	75
Env Amp	Decay	72
Env Amp	Sustain	76
Env Amp	Release	73

Function	Parameter	CC Number
Env Filter	Attack	80
Env Filter	Decay	81
Env Filter	Sustain	82
Env Filter	Release	83

Function	Parameter	CC Number
Env Aux	Attack	46
Env Aux	Decay	47
Env Aux	Sustain	48
Env Aux	Release	49

WTFM Synth Engine

Function	Parameter	CC Number
Engine P1	Ratio 1	23
Engine P1	Ratio 2	24
Engine P1	FM	20
Engine P1	Shape 1	22
Engine P1	Shape 2	27
Engine P1	Feedback 1	21
Engine P1	Feedback 2	28
Engine P1	Feedback 2>1	29
Engine P2	Finetune 1	26
Engine P2	Finetune 2	25

Function	Parameter	CC Number
Filter	Cutoff	74
Filter	Resonance	71
Filter	Env Amount	77

Function	Parameter	CC Number
Env Amp	Attack	75
Env Amp	Decay	72
Env Amp	Sustain	76
Env Amp	Release	73

Function	Parameter	CC Number
Env Filter	Attack	80
Env Filter	Decay	81
Env Filter	Sustain	82
Env Filter	Release	83

Function	Parameter	CC Number
Env Aux	Attack	46
Env Aux	Decay	47
Env Aux	Sustain	48
Env Aux	Release	49

PMD Synth Engine

Function	Parameter	CC Number
Exciter [Engine]	Bow Level	20
Exciter [Engine]	Air Level	22
Exciter [Engine]	Strike Level	25
Exciter [Engine]	Bow Timbre	21
Exciter [Engine]	Air Timbre	24
Exciter [Engine]	Strike Timbre	27
Exciter [Engine]	Air Flow	23
Exciter [Engine]	Strike Mallet	26

Function	Parameter	CC Number
Resonator [Filter]	Form	70
Resonator [Filter]	Position	85
Resonator [Filter]	Space	86
Resonator [Filter]	Brightness	74
Resonator [Filter]	Damping	71

Function	Parameter	CC Number
Env Exciter	Attack	75
Env Exciter	Decay	72
Env Exciter	Sustain	76
Env Exciter	Release	73

Function	Parameter	CC Number
Env Aux	Attack	46
Env Aux	Decay	47
Env Aux	Sustain	48
Env Aux	Release	49

PHZ Synth Engine

Function	Parameter	CC Number
Engine P1	Shape 1	22
Engine P1	Shape 2	27
Engine P1	Mix	20
Engine P1	Osc1 XMod	21
Engine P1	Osc2 XMod	28
Engine P1	Osc1 YMod	23
Engine P1	Osc2 YMod	29
Engine P2	Detune	24
Engine P2	Tune 1	25
Engine P2	Tune 2	30
Engine P2	Finetune	26

Function	Parameter	CC Number
Filter	Cutoff	74
Filter	Resonance	71
Filter	Env Amount	77

Function	Parameter	CC Number
Env Amp	Attack	75
Env Amp	Decay	72
Env Amp	Sustain	76
Env Amp	Release	73

Function	Parameter	CC Number
Env Filter	Attack	80
Env Filter	Decay	81
Env Filter	Sustain	82
Env Filter	Release	83

Function	Parameter	CC Number
Env Aux	Attack	46
Env Aux	Decay	47
Env Aux	Sustain	48
Env Aux	Release	49

GRAIN Synth Engine

Function	Parameter	CC Number
Engine P1	Position	20
Engine P1	Position Spread	21
Engine P1	Grain Size	24
Engine P1	Density	23
Engine P1	Time Spread	22
Engine P1	Grain Shape	25
Engine P1	Pan Spread	27
Engine P2	Tune	30
Engine P2	Detune Spread	26
Engine P2	Finetune	31
Engine P2	Size Spread	87
Engine P2	Direction	86
Engine P2	Space	85

Function	Parameter	CC Number
Filter	Cutoff	74
Filter	Resonance	71
Filter	Env Amount	77

Function	Parameter	CC Number
Env Amp	Attack	75
Env Amp	Decay	72
Env Amp	Sustain	76
Env Amp	Release	73

Function	Parameter	CC Number
Env Filter	Attack	80
Env Filter	Decay	81
Env Filter	Sustain	82
Env Filter	Release	83

Function	Parameter	CC Number
Env Aux	Attack	46
Env Aux	Decay	47
Env Aux	Sustain	48
Env Aux	Release	49

9

System

While this section may appear dull at face value (I guess in many ways, that could be true), don't overlook the content. There are some elements that at least are useful to be aware of. For example, it can be used to interface with a PC or Mac as an external storage device. There are also some valuable tips and advice that may help if you are in a sticky situation, such as details of main menu options, microSD card details, and system specifications. Also, there are some topics that might be useful around housekeeping and good disciplines in working with Synth. However, there are also some essential administrative duties to consider. The general firmware update options are covered in this section, although it is always recommended to

follow Polyend's guidelines and instructions with each firmware release, as these may change per update. The active firmware version is displayed on the start-up screen and in the firmware option in the main menu settings. Other options, such as user interface behavior based on personal taste, are covered. Registration of the device is required to access downloadable content and firmware updates. Registration is performed at [Polyend.com](https://polyend.com). This section not only covers system-wide features and firmware update details but also is a catch-all for topics not covered elsewhere in this manual.

9 System

9.1 Generic Firmware Update

NOTES

Firmware updates may be provided by Polyend from time to time, to fix bugs or add new features. The process of updating can be performed in several ways. When performing updates it is strongly advised to follow the Polyend instructions supplied with each update. The instructions here are a generic guide only. Ensure your device is registered with Polyend.

FIRMWARE UPDATE

1. Download the latest firmware. Access firmware updates for your device from your registered account at Polyend.
2. Copy the downloaded .psf firmware file into the /Firmware folder. This can be found in the root directory of the microSD card.
3. Insert the microSD card into Synth and power up.
4. Press (Screen) knob to open the configuration and settings menu.
5. Navigate through the 'System Settings' and 'Firmware' menus. Open the 'Firmware Update' function, highlight the firmware version to install.
6. Press (Screen), knob to select firmware.
7. The screen will prompt "Yes' or 'No' to confirm using the left screen buttons. To continue press [Yes].
8. The firmware will install and the on screen prompts provided will guide. The install process is typically less than 1 minute.
9. Synth should restart automatically. If not and only when the update is 100% completed, press On/Off to perform a manual start.

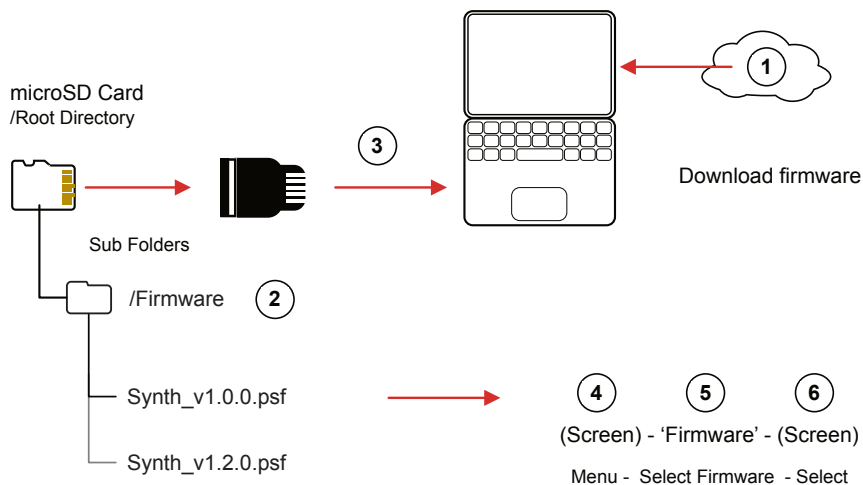

9.2 Emergency Firmware Update

Firmware updates are available from the Polyend portal for your registered device. A reset button is provided, recessed behind the rear panel for emergency situations. A reset can be performed if there are issues with the update method or to clear Synth issues but should not be used as a regular process for updates.

SYNTH AND FIRMWARE RESET

1. Download the latest firmware. Access firmware updates for your device from your registered account at Polyend.
2. Copy the downloaded .psf firmware file into the /Firmware folder. This can be found in the root directory of the microSD Card. Also ensure any previous update files remain in the firmware folder.
3. Insert the microSD card into Synth.
4. Use a pin or thin object to press the internal reset button. This is located on the rear of the device behind the case next to the USB connection.
5. Synth will reset and search the firmware folder on the microSD card. A random firmware will be selected and installed in order to recover Synth to a working state. The install process is typically less than 1 minute.

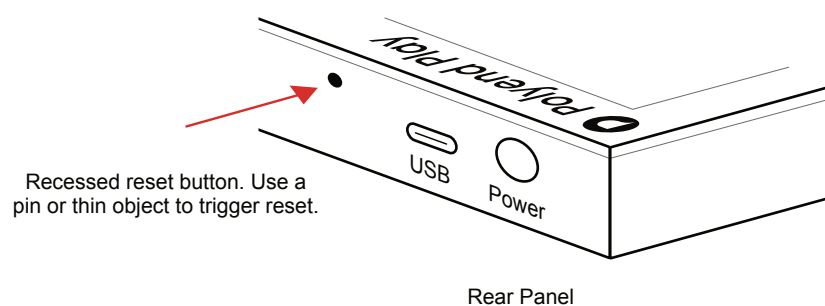

The reset option is useful if any lock ups or freezing occurs on Synth. It is not necessary in these situations to download a new OS. It is advised to keep a series of official, known good, firmware releases in the /firmware folder. For example 1.2.0, 1.3.0, 1.4.0. That way steps 4-5 can be performed in case of issues and a random update will be performed from a known state. A manual update in the main menu to select the latest version can then follow. If problems persist, try updating after removing the 'workspace' folder from the microSD card.

9.3 Grid Pad Behavior Settings

A number of grid pad preferences that affect the user experience when using the pads are configurable in the main menu settings, accessed by pressing the (Screen) knob. These include pad sensitivity and aftertouch.

CHANGING GRID SENSITIVITY

1. Press (Screen) knob to open the main menu.
2. Navigate using the screen knob to the 'System Settings' menu option. Press (Screen) to select and open this menu.
3. Navigate using the screen knob to the 'Grid Sensitivity' option. Press (Screen) to select and open the options.
4. The grid sensitivity options are listed. Navigate using the screen knob to the option desired. Normal is default. Press (Screen) to select desired option.

CHANGING THE PAD AFTERTOUCH BEHAVIOR

1. Press (Screen) knob to open the main menu.
2. Navigate using the screen knob to the 'System Settings' menu option. Press (Screen) to select and open this menu.
3. Navigate using the screen knob to the 'Aftertouch Mode' option. Press (Screen) to select and open the options.
4. The aftertouch options are listed:
 - Off. No aftertouch is applied when using the pads.
 - Immediate. Aftertouch is applied immediately a pad is pressed.
 - Delayed. Aftertouch is applied but with short delay from when a pad is pressed to the aftertouch value being applied.

Pads are velocity sensitive registered when pressing a pad. Also aftertouch applies a pressure value after the pad is played in order to vary the note after it is triggered. Velocity is how hard the pad is played and aftertouch is how the pad pressure is varied after the initial trigger.

9.4 USB Storage Mode

Synth can be set to USB storage device mode. This means that the microSD Card can be accessed from a connected Mac or PC, recognised as an external drive.

SETTING UP USB STORAGE MODE

1. Connect a PC or Mac to Synth using a USB cable.
2. Press (Screen) Knob to open the main menu.
3. Navigate using the screen knob to the 'System Settings' menu option. Press (Screen) to select and open this menu.
4. Navigate using the screen knob to the 'Enter USB Storage Mode' option. Press (Screen) to select.
5. The microSD Card installed in Synth is now accessible from the PC or Mac file manager. This will be accessed the same way as an external drive.
6. Once complete eject the drive from the PC or Mac and press [Back] to exit the option from Synth.

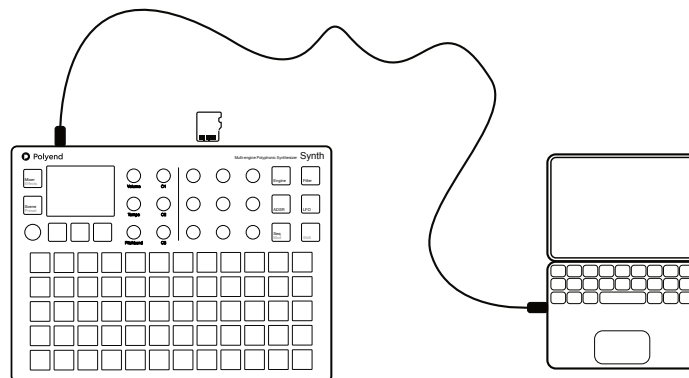

9.5 microSD Card Compatibility & Backing Up

It is always good practice to backup, or even better, have a spare microSD card loaded and ready for use with Synth. The following information on microSD compatibility is essential:-

- A 16GB microSD Card is supplied with Synth. Larger size microSD cards can also be used. Supplied microSD card is: Sandisk Ultra, microSD, 16GB, HC1 A1.
- The format of the card must be FAT32 MBR (Master Boot Record). Other formats will not be recognised.
- Synth uses the microSD card in real time and will not function without the microSD card being installed. A 'bad' folder / file structure on the microSD card may also cause Synth problems.
- It is good practice to create a duplicate copy of the microSD card for backup purposes. Also if Synth does not boot up and crashes, restoring the full original folder / files structure or using the backup microSD card is advised.
- Synth is supplied with an microSD Card USB Type A reader for use with most Mac / PC's which helps transfer files.
- Polyend typically provide pre-release firmware as open beta. While this is great to get early insights into new features, by definition beta releases will have inherent problems. Only use beta versions to help test for bugs and features and do not use in a live gig or critical production environment.

Tip: microSD cards can be notorious in there levels of performance with various gear. This is mainly due to the wide variety of speeds and specifications available. Gear producers do not and in fact cannot test every single microSD specification or each of the manufacturers products. It is therefore recommended to stick as close as possible to the same microSD Card type that the manufacturer supplies with its devices. At least it is known that this microSD card type will then have been tested thoroughly with the device itself by the manufacturer as well as the user community.

BACKING UP THE microSD CARD FOLDERS & FILES

1. This is recommended as a first task when first operating Synth in order to have the original structure saved. Also periodic backups is important to save the projects and files which will be created over time.
2. Use a compatible microSD card reader or the supplied USB adapter to connect the microSD card to a PC or Mac. It is also possible to connect in USB storage mode.
3. Use the file manager (depends on the PC/Mac Operating System) to create a 'Synth Backup' Folder in your documents folder and create a sub folder for each backup i.e. 'Original Aug24', 'Backup1 May25'. It is good practice to name backup folders by date.
4. Select all of the folders in the microSD Card root directory and copy them to the PC/Mac clipboard.
5. Paste, the copied folders into the 'Synth Backup' sub-folder for the specific backup.
6. Return the microSD card to Synth for normal operation.

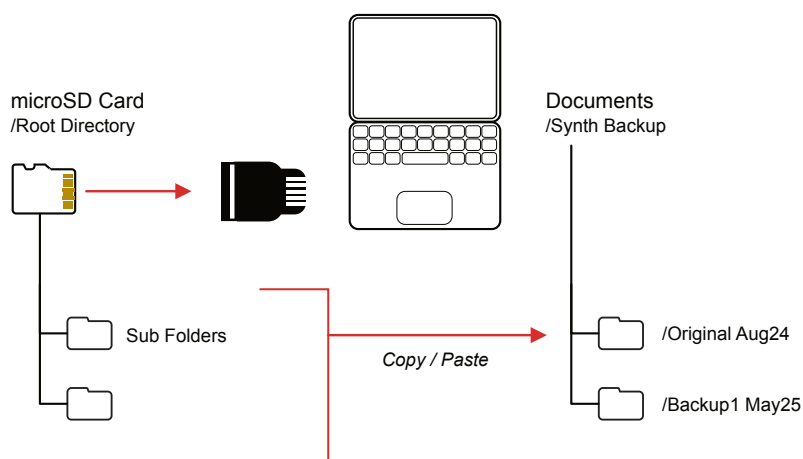

9 System

9.6 CPU Performance Considerations

NOTES

The CPU loading in Synth will vary depending on the complexity of the presets and the type of synths loaded. Understanding some important considerations when designing presets with respect to CPU loading and performance is helpful.

- Any assigned voice to a Synth will add load to the CPU even if that voice isn't used, playing or not.
- PMD and Grain are the most resource-intensive Synth engines. CPU loading can be improved for Grain by rolling off the density. For PMD, the array is how many filter banks are being used, so if you turn that down, it will change the tone but get better performance.
- Concerning single-note arps and sequences, there is no need to set high polyphony. Use 2 voices if the gate length is over 100; 1 voice is all that is needed if it is under 100 on gate length. The exception is playing back chord packs via the sequencer or chord modes on the arp.
- CPU 'high' messages mean you are at the edge of the CPU limit. You can usually get away with staying in this area if you 'finish' a scene the first time you see this message. Audio clicks are more likely to occur on Chords once you are in the high CPU range, so this is something to watch out for once you see the CPU high message.
- If audio clicks occur with factory presets, try changing the voices to a lower number. This will reduce CPU load. For example, Scene Atcha_SunrisePeaking has multiple voices assigned for the arp. Change the blue Synth 1 and set all synth voices to 1 to reduce CPU loading to a more appropriate level.

9.7 Official Specifications

Audio Output

- Line Output:
 - Output level 9 dBu peak (when 10k Ohm Load).
 - Signal to Noise Ratio: 97 dB.
- Headphone Output:
 - Output level: 17.6 dB (when 16k Ohm Load)
 - Signal to Noise Ratio: 98 dB.
- Power Supply:
 - 5V / 1A Supply via USB-C

Whats in the Box?

- Original USB A power adapter (with different standard plugs set).
- Branded USB-C cable (2 m).
- 1x Stereo 3.5 mm jack to 2x 6.3 mm jack adapter.
- 1x MIDI Type B, 3.5 mm jack to DIN adapter.
- 16GB microSD card.
- microSD to USB-A dongle adapter.
- Warranty & Safety and Polyend Synth Essential information brochures

9.8 Changelog

OS & Manual	Feature Update	Manual Update
1.1.0 a		Changelog added (this table) for OS and content updates. Page 144.
	New Arp / Seq Rate. Total 12 divisions.	Arp table, Page 116. Seq table, Page 113.
	Chord pack editor improvements, renaming including adding the initialize option.	Chord pack editor. Page 44 & 45.
1.2.0 a	Hung Notes - All Notes Off Command added.	The main menu contains this command. Updated in tables and also in notes section. Pages 26, 27, 40.
	Pads and display is dimmable.	The main menu, settings contains this command. Updated in tables and grid section. Pages 26, 27, 38.
	MIDI clock missing message shown on screen. Supports the changes that show screen alerts for no sound situations.	MIDI Section. Page 124.
	Performance for CPU and Clipping enhancements. - Global volume set to dB. - Mixer levels - Red clipping indicator. - Mixer sends range -90dB to 0dB.	Changes made. - Global volume graphic - Page 17. - Mixer level table text - Page 106. - Mixer send guide - page 105.
1.3.0 a	- New DWA Synth engine added. - New grid layouts 2plus1 and 3 in 1. - Customizable colors for synth pad layouts. - MIDI Input pad mapping - MIDI Instrument in synth engines - Aftertouch update	Updated to match new 1.3 OS. - Synth Summary - Page 48-49. - DWA Synth added Pages 85-89. - Color & layout options added. Page 27, 37. - MIDI input & voice Image and text. Page 41, 125. - MIDI Instrument. Page 48, 90, 127. - Aftertouch settings. Page 26, 27.
1.3.0 b		Minor edits - Page 124 - Transport / Clock clarification
1.3.0 c		Minor edits - Page 113-115 Added 'rests' in sequencer instructions
2.0.0 a	Dirt Synth added Scene Selection with Grid Pads Various fixes	Dirt Synth added - Page 48-49, Page 90-91 Scene Selection - Page 29 & Page 31 updated. Updates pages, index and contents.
2.0.0 b		Minor typo corrections. Page 54, 62, 75
2.0.0.c		Loop start and end error fixed. Page 86

12

Index

Index

A

Ableton Live 132

ACD 54

ADSR 109

Aftertouch 140

Arp 114, 118–119

B

Backing Up 142

C

Changelog 146

Chord Pack 43

Chord Pack Editor 44–45

Chords 42

Clear Pattern 116

Clock In

126

Clock Out 126

Colors 37

Control Change Mapping 128

CPU 144

D

DAW 132

Delay 103, 105

Destination 109

Dirt 90

Display 14

DWA 85

E

Effect 102

Envelopes 98, 109

External Keyboard 127

F

FAT 57

Filter 96

Firmware Update 138

Follower 43

G

Gain Staging 111

Gate Length

115, 118

GRAIN 81

Grid 39

Grid Layout 37

Grid Mapping 38

Grid Pads 12, 36, 140

Grid Sensitivity 140

Groove 115, 118–119

Index

H

Hardware 11
Humanize 115, 118

L

Level 108, 111
LFO 109
Local Mode 127

M

Macro 12, 93
Main Menu 26
microSD 13, 25, 49, 142, 145
MIDI 11
MIDI CC 124–126, 128, 133
MIDI Channel 127–128
MIDI PC 124, 130, 132
MIDI Terms 124
MIDI TRS 125
MIDI USB 125
Mixer 108
Mod 103–104
Modifier 109

O

Oct Range 118

P

Pad 17
Pad Mapping 127
Pan 108
Parameter Knobs 12, 15
PHZ 76, 80
Pitchbend 12
PMD 73
Polyphony 39–41
Power Input 145
Preset 49
Program Change Mapping 130

R

Rate 115, 118
Record Mode 115–116
Reset 11, 139
Reverb 103, 106
Root 36

S

Scale 36
Scenes 30
Screen Knob 12, 15
Sends 107

Index

Sequencer 114–115

Settings 26

Shift 12

Shortcuts 19

Specifications 145

Swing 12, 115, 118

Synth Engine 48

T

Tempo 12

U

USB Power 11, 13

USB Storage Mode 141

V

VAP 65

Velocity 140

Voices 41

Volume 17

W

WAV files 64

Wavetable 64

WAVS 60

WTFM 69

Copyright © 2026 by Polyend

All rights reserved. This book or any portion thereof may not be reproduced or used in any manner whatsoever without the express written permission of the publisher except for the use of brief quotations in a book review.

Produced in the United Kingdom

May 2026 - Synth OS 1.2.0 c

www.synthdawg.com

Synthdawg

 **Polyend**

